



# RAD

The Radiology Guide to Technology and Informatics in Europe

# BOOK 2015

- |                              |                       |
|------------------------------|-----------------------|
| ■ Computed Tomography        | ■ R/F Film-Screen     |
| ■ Magnetic Resonance Imaging | ■ R/F Digital         |
| ■ Injectors                  | ■ Molecular Imaging   |
| ■ Interventional Systems     | ■ Displays / Printers |
| ■ IT Systems                 | ■ Ultrasound          |
| ■ Mammography                | ■ Testing Devices     |



**Infinix<sup>4D</sup>CT**

Toshiba's innovative Infinix<sup>4D</sup> CT combines premium CT imaging with the most flexible ceiling-mounted angiography technology into a single work place. This integrated clinical concept is the perfect setup for advanced procedures in various segments of interventional imaging such as interventional oncology, trauma, neuro/stroke and general vascular. Infinix<sup>4D</sup> CT is available with Aquilion ONE Vision Edition, Aquilion PRIME or Aquilion LB. For more information about Toshiba please see pages 14/15 and 24/25 and [www.toshiba-medical.eu](http://www.toshiba-medical.eu).

# IT-SOLUTIONS



**TERARECON**  
Advanced Visualization

*Operate  
at a higher  
level*

Enterprise-class  
vendor-neutral 3D  
post-processing  
solutions



**iNtuition™**  
terarecon.com

	Management	Archiving	
	RIS	Small Business PACS	Enterprise PACS
<b>AGFA</b> <small>Agfa</small> HealthCare	Orbis RIS	Impax	Impax
<b>Canon</b>	Canon Healthcare IT Suite	Canon Healthcare IT Suite	Canon Healthcare IT Suite
 <b>CHILI™</b> Digital Radiology		CHILI Modality PACS	CHILI PACS
<b>eBit</b> <small>an Esaote Group Company</small>	Suitestensa RIS	Suitestensa PACS	Suitestensa PACS
<b>FUJIFILM</b>	SYNAPSE RIS	SYNAPSE SYNAPSE Modality Bundle	SYNAPSE PACS SYNAPSE 3D SYNAPSE VNA SYNAPSE MOBILITY
 <b>GE Healthcare</b>	Centricity RISi with eRadCockpit	Centricity PACS with Universal Viewer	Centricity PACS with Universal Viewer
 <b>IMAGE</b> Information Systems	iQ-RIS	iQ-MOBILITY	iQ-SYSTEM PACS
 <b>i-SOLUTIONS</b> HEALTH	RadCentre RadCentre Analytics RadCentre Reporting Solutions	RadCentre Multi-PACS Integration	RadCentre Multi-PACS Integration
 <b>itz-medi.com</b> PACS & Telemedicine	ITZ Hyper.RIS	ITZ Hyper.ePACS	ITZ Hyper.PACS
 <b>KONICA MINOLTA</b>		Acies ImagePilot	Acies
 <b>medigration</b> The Digital Company <small>ein Unternehmen der bender gruppe</small>	WinRadiolog RIS	ImageBroker XS	ImageBroker
 <b>PROTEC</b> TEAM   SPIRIT   ABILITY		CONAXX 2 and PROPAXX	
<b>SECTRA</b>	Sectra RIS	Sectra PACS	Sectra PACS Business Analytics
<b>SIEMENS</b>		syngo.plaza	syngo.plaza
 <b>TERARECON</b>		JiveX Radiology	JiveX Enterprise
 <b>VISUS</b>			
<b>VITAL</b> <small>A Toshiba Medical Systems Group Company</small>			



## Archiving

## Image Distribution

Cardiology PACS	Long Term	Multimedia	Inhouse	Teleradiology	Portal Solution	Cloud Computing Application
Impax for Cardiology	ICIS VNA	ICIS HYDMedia	ICIS Enterprise Imaging Suite Xero Viewer	ICIS Enterprise Imaging Suite Xero Viewer	ICIS	ICIS
	Canon Healthcare IT Suite	Canon Healthcare IT Suite	Canon Healthcare IT Suite	Canon Healthcare IT Suite	Canon Healthcare IT Suite	Canon Healthcare IT Suite
CHILI PACS	CHILI PACS	CHILI PACS	CHILI/Web	CHILI/Web	CHILI/Telemedicine Record	OmniPACS
Suitestensa CVIS	Suitestensa Archive	Suitestensa	Suitestensa Web Suitestensa Mobile	Suitestensa Web Suitestensa Mobile	Suitestensa Web	Suitestensa Web Suitestensa Mobile
SYNAPSE CARDIOLOGY	SYNAPSE SYNAPSE PACS SYNAPSE CARDIOVASCULAR SYNAPSE 3D · SYNAPSE VNA	SYNAPSE · SYNAPSE PACS SYNAPSE CARDIOVASCULAR SYNAPSE 3D SYNAPSE MOBILITY	SYNAPSE · SYNAPSE PACS SYNAPSE CARDIOVASCULAR SYNAPSE Mobility SYNAPSE 3D	SYNAPSE SYNAPSE PACS SYNAPSE MOBILITY	SYNAPSE SYNAPSE PACS SYNAPSE MOBILITY	SYNAPSE SYNAPSE PACS SYNAPSE 3D SYNAPSE MOBILITY
Centricity PACS with Universal Viewer	Centricity PACS with Universal Viewer	Centricity Clinical Archive (VNA L1-L4, XDS Repository)	Centricity PACS with Universal Viewer Zero Footprint	Centricity PACS with Universal Viewer Zero Footprint, Centricity 360	Centricity RIS with eRadCockpit, Centricity 360	Centricity 360
			iQ-MOBILITY	iQ-MOBILITY	iQ-MOBILITY	iQ-MOBILITY
	RadCentre Archiving Solution	RadCentre Archiving Solution	Health Relation RC	Health Relation RC	Health Relation RC	Radiology as a Service
ITZ Hyper.PACS	ITZ Hyper.ARC	ITZ Hyper.PACS ITZ Hyper.WEB	ITZ Hyper.WEB	ITZ Hyper.TELEMED, ITZ Hyper.COM Dicom2Mail-Module	ITZ Hyper.WEB ITZ Hyper.TELEMED ITZ Hyper.COM	ITZ Hyper.PACS Telearchive ITZ Hyper.WEB Cloud
	Acies ImagePilot	Acies ImagePilot	Acies ImagePilot	Acies ImagePilot		
ImageBroker	ImageBroker	ImageBroker	ImageWeb	webConnect	PraxisPortal	PraxisPortal App
Sectra Open Archive	Sectra PACS Sectra Open Archive	Sectra PACS Sectra Image Central Sectra Open Archive / VNA 2.0	Sectra PACS Sectra LiteView	Sectra PACS Sectra IEP	Sectra LiteView Sectra Order Management	Sectra IEP Sectra DXR Online Sectra OneScreen Sectra Private Cloud
syngo Dynamics	syngo.plaza syngo.share	syngo.plaza syngo.share	syngo.plaza syngo.share	syngo.plaza syngo.share	syngo.plaza syngo.share	teamply syngo.plaza syngo.share
			iNtuition, iNtuitionEMV, iNtuitionReview, iNteract+	iNtuition, iNtuitionCloud, iNtuitionSHARE, iNteract+	iNtuition, iNtuitionCloud, iNteract+	iNtuitionCloud
JiveX Cardiology JiveX ECG	JiveX Archive Manager JiveX Storage Service for PACS (SSP)	JiveX Integrated Imaging JiveX Medical Archive	JiveX Review JiveX Web JiveX Mobile	JiveX Telemedicine	JiveX Web	JiveX Application Service for PACS (ASP)
			Vitre Enterprise Suite VitreAdvanced VitreView	Vitre Enterprise Suite VitreView	VitreView	VitreView



Next generation digital R/F system:  
Sorialvision G4

## Best-in-class

Equipped with the largest available FPD at 43 x 43 cm and Shimadzu's newly developed digital imaging platform, the Sorialvision G4 covers the widest possible range of examinations with inter-departmental hospital capability. In both functionality and operability, the Sorialvision G4 multipurpose R/F table is far beyond other R/F systems. It provides "Best-in-class" features.

- **Smart system architecture** supports outstanding clinical flexibility for a wide range of examinations
- **Comprehensive dose management package** ensures today's highest safety of patients and operators
- **Excellent image quality** provided by the advanced "SUREngine" technology enhancing the entire image for clearer details
- **Premium application software** supporting useful applications, such as tomosynthesis for general radiographic imaging

[www.shimadzu-medical.eu](http://www.shimadzu-medical.eu)





## Dear Reader,

for the past few years the most exciting innovations in diagnostics and therapy have been happening in hybrid imaging. A hybrid system is defined as the fusion of two imaging modalities into a new system which offers considerable added value by allowing the simultaneous application of diagnostic and treatment procedures.

The best known hybrid systems are SPECT/CT and PET/CT as well as PET/MR. Fusions of radiological and oncological modalities are important as they match morphology and function: the radiologist localizes the pathology with CT and MRI and follows the metabolic processes with PET. Image-guided radiotherapy (IGRT) fuses diagnostic X-ray systems with linear accelerators to respond to changes in tumor location right during radiotherapy in order to spare healthy tissue.

The latest innovation in hybrid systems is the combination of CT and X-ray which Toshiba is about to launch: In a hybrid operating theater a computed tomography scanner is combined with an angiography system to achieve the perfect setup for high-risk procedures in various segments of interventional imaging such as interventional oncology, trauma, neuro/stroke and general vascular.

RadBook 2015 presents the current imaging developments from A as in angiography to Z as in z-axis.

Enjoy browsing!  
Your editorial team

**Daniela Zimmermann** and **Guido Gebhardt**

**HITACHI**  
Inspire the Next

Embracing Life  
through Healthcare Innovation.

Hitachi recognizes the significance of healthcare in our society today and in our shared future. Utilizing our innovative technologies, Hitachi is committed to improving the diagnosis and treatment of disease while enhancing the patient experience and delivering diagnostic confidence.

[www.hitachi-medical-systems.com](http://www.hitachi-medical-systems.com)



5 Editorial / Imprint

## Trends & Topics

- 10 Siemens: SOMATOM Definition Edge brings Dual Energy to routine CT Imaging
- 14 Toshiba: New technology allows scanning everyone
- 24 Toshiba: Vantage Elan delivers premium MR performance CT
- 46 Medtronic: Q-arm – Mobile Surgical Imaging System
- 65 Visus: Radiologists discover the benefits of a medical archive
- 98 Shimadzu: Deep insights for extended applications
- 136 NDSsi: Calibration – Important facts to know

## 8 Computed Tomography

- 9 Dual Source
- 9 Volume CTs
- 16 20 to 64 Slices
- 17 2 to 16 Slices
- 18 Oncology CT
- 20 Digital Volume Tomography
- 21 Accessories / Complementary Systems

## 23 Magnetic Resonance Imaging

- 26 3 Tesla
- 28 1.5 Tesla
- 32 Open
- 35 MR-PET
- 35 Surgical MR
- 36 MRT Coils
- 37 Accessories / Complementary Systems

## 38 Injectors

## 45 Interventional Systems

- 48 Hybrid
- 48 Bi-Plane
- 49 Single Plane
- 53 Surgical II-C-Arms
- 57 Surgical Flat Panel C-Arms
- 59 Accessories / Complementary Systems

## 60 IT Systems

- 61 RIS / PACS
- 66 Advanced Visualization
- 70 Portal Solution
- 71 CAD
- 72 Mammo Workstation
- 74 Mobile RIS / PACS Viewer
- 76 Accessories / Complementary Systems

## 77 Mammography

- 78 Tomosynthesis
- 78 Digital Mammography
- 81 Film-Screen Mammography
- 82 Biopsy Tables
- 84 Accessories / Complementary Systems

## 86 R/F Film-Screen

- 87 Bucky
- 88 Fluoroscopy
- 91 X-Ray Mobile
- 94 Accessories / Complementary Systems

## 96 R/F Digital

- 97 Conventional
- 102 Digital
- 112 DR Retrofit
- 118 Mobile DR
- 121 Flatpanel Fluoro
- 126 Accessories / Complementary Systems

## 129 Molecular Imaging

- 130 SPECT
- 131 SPECT-CT
- 132 PET-CT
- 133 PEM
- 133 Accessories / Complementary Systems

## 134 Displays / Printers

- 135 Displays – Mammography
- 138 Displays – Color
- 143 Displays – Grayscale
- 146 Displays – Clinical Review
- 147 Displays – Large Format
- 148 Printers
- 150 CD-/DVD-Robot
- 150 Accessories / Complementary Systems

## 152 Ultrasound

- 172 Accessories / Complementary Systems

## 173 Testing Devices

- 3 IT-Solutions Table – pt1
- 184 Index of Advertisers
- 186 Companies / Suppliers
- 197 IT-Solutions Table – pt2

Published by:

**EUROPEAN HOSPITAL Verlags GmbH**

Theodor-Althoff-Straße 45 · 45133 Essen · Germany · Phone +49-201-87126-851 ·  
www.healthcare-in-europe.com and **X-ray Media** Guido Gebhardt · Adalbert-Stifter-Weg 2b ·  
85661 Forstinning · Germany · Phone +49-8121-907630 · www.radiologieforum.de

**Editor-in-Chief:** Guido Gebhardt · Daniela Zimmermann · **Executive Director:** Daniela Zimmermann

**Advertising:** Ralf Mateblowski (D, A, CH) · Eric Jund (E, F, I) · Simon Kramer (B, GB, L, NL)  
Gavin Hua (China) · Jane Park (Korea) · Hanna Politis (U.S.A, Canada)

**Art Directors:** Almut & Christoph Muschiol · Agentur für Werbung, Beratung & Organisation · Dorfen ·  
Germany · www.muschiol-online.de · **Printing:** Margreff-Druck GmbH · Essen · Germany

**Subscription:** Janka Hoppe · **Subscription rate:** € 19.– plus postage

The information and opinions expressed in articles and product entries published in RADBOOK are solely those of the manufacturers / companies, their authors and contributors, for which the publisher holds no responsibility. Errors and omissions excepted.

**Disclaimer:**

All company, brand and product names in this publication are the property of their respective holders. Not all products are available in all European countries.

Please note that the manufacturers' websites may contain further product disclaimers.

© 2015 by EUROPEAN HOSPITAL Verlags GmbH. All rights reserved.

## IMPRINT



SIEMENS

[www.siemens.com/somatom-definition-edge](http://www.siemens.com/somatom-definition-edge)

## “Exceeding expectations” VS. “Accepting the average”

Second best is not an option.

Confronted with increasingly complex clinical requirements and rising numbers of patients, medical institutions are expected to perform at the limits of capacity every day. Healthcare innovation leader Siemens invites them to expand their clinical capabilities – and not only meet, but exceed those expectations.

**Exceeding expectations in Cardiology**, you will be able to expand your clinical capabilities – not only by catching the bolus when performing TAVI planning but also by improving contrast media efficiency, introducing highly precise plaque differentiation, and enabling reliable, high-speed triple rule-out scanning.

**Exceeding expectations in Emergency Medicine**, you will be able to optimize process efficiency with solutions that let you not only improve emergency workflow but also substantially reduce door-to-image time, from pediatric to obese patients.

**Exceeding expectations in Oncology**, you will be able to improve patient outcome not only by precisely identifying tumors but also by reliably evaluating therapy response and implementing improved low-dose therapy control and early detection.

The new **SOMATOM Definition Edge** expands your clinical capabilities and helps you and your institution perform to your full potential. Because when it comes to your patients well-being, second best is not an option.

Answers for life.



# Computed Tomography

Dual Source  
Volume CTS  
20 to 64 Slices  
2 to 16 Slices  
Oncology CT  
Digital Volume Tomography  
Accessories /  
Complementary Systems



**DUNLEE**

A Division of Philips Healthcare



GE Healthcare



GCTechnology GmbH

**Planmed**

**HITACHI**  
Inspire the Next

**SOREDEX**

**SIEMENS**

**TOSHIBA**

**VARIAN**  
medical systems



**DUAL SOURCE**

**Siemens · SOMATOM Force**

<b>Acquired slices / rot</b>	384 (2 x 192)
<b>Power reserves</b>	Up to 2,600 mA (2 x 1,300 mA)
<b>Scan speed</b>	Up to 737 mm/sec
<b>4D scan range</b>	Up to 80 cm



**Highlights**

- Kidney-friendly scanning with significantly reduced contrast media amounts required
- Low dose early detection with up to 50% dose reduction
- "Free-breathing" CT imaging with outstanding native temporal resolution
- The fastest, most versatile scan mode with the Turbo Flash spiral
- 4D imaging at half the dose
- Precise Dual Energy quantification to add tissue information to morphology

**Siemens · SOMATOM Definition Flash**

<b>Acquired slices / rot</b>	256 (2 x 128)
<b>Generator power</b>	200 kW (2 x 100 kW)
<b>Acquired temp. res.</b>	75 ms (0.28 s with Dual Source)
<b>Dual Energy</b>	Yes, dose neutral (Dual Source)



**Highlights**

- FAST CARE technology for workflow optimization (like FAST DE Results, FAST 3D align etc)
- Stellar detector for optimized low dose imaging and increased spatial resolution
- Split-second thorax imaging: avoiding breath hold or sedation in pediatric patients
- Sub-mSv heart scanning to cover the entire heart in only 250 ms
- ADMIRE – Siemens' Advanced Modeled Iterative Reconstruction – smoothly integrates iterative reconstruction
- Dose neutral Dual Energy for a second contrast in daily routine

**VOLUME CTS**

**GE Healthcare · Optima CT660 FREEdom**

<b>Channels</b>	128
<b>Rotation</b>	0.35 s (cardiac 0.058 s equivalent with Snapshot Freeze)



**Highlights**

- 64 and 128 slices imaging
- Latest innovations in a 40 mm detector CT
- Leadership in advanced cardiac CT
- Intelligent cardiac CT with Snapshot
- Assist and Snapshot Freeze
- Unique workflow features
- Real time recon (55 fps)
- Fast acquisitions with high helical pitch (1.531)
- Automatic reconstruction with 10 PMR
- Up to 500 slices coverage for perfusion
- 60% lower CO<sub>2</sub> emission and energy saving
- Scalable and modular
- Compact for easy siting (18 sqm)
- Integrated ASiR reconstruction

**GE Healthcare · Optima CT660 Spatial Enhanced**

<b>Coverage</b>	40 mm isotropic, 128i – 0.625 mm (overlap), 64i – 0.625 mm (overlap), 32i – 1.25 mm, 16i – 2.5 mm, 8i – 5 mm, 4i – 10 mm
<b>Channels</b>	128
<b>Rotation</b>	0.4 s (cardiac 0.35 s)



**Highlights**

- 64 and 128 slices imaging
- Latest innovations in a 40 mm detector CT
- Leadership in advanced cardiac CT
- Intelligent cardiac CT with Snapshot
- Assist and Snapshot Freeze
- Unique workflow features
- Real time recon (55 fps)
- Fast acquisitions with high helical pitch (1.531)
- Automatic reconstruction with 10 PMR
- Up to 500 slices coverage for perfusion
- 60% lower CO<sub>2</sub> emission and energy saving
- Scalable and modular
- Compact for easy siting (18 sqm)
- Integrated ASiR reconstruction

**GE Healthcare · Discovery CT750 HD**

<b>Channels</b>	64
<b>Spatial resolution</b>	18.2 lp/cm



**Highlights**

The Discovery CT750 HD can reach any part of the body of virtually any patient and perform both generalized and specialized clinical applications, including:

- Gemstone Spectral Imaging – the first quantitative dual-energy CT on the market
- Cardiac imaging – highest spatial resolution in the industry at 18.2 lp/cm
- Neuro imaging – the Discovery CT750 HD ensures ample coverage to perform perfusion studies of the entire brain

**Hitachi · SCENARIA**

<b>Slices per rotation</b>	64 / 128
<b>Spatial resolution</b>	17.1 Lp/cm
<b>Power</b>	72 kW



**Highlights**

- X-ray tube: 7.5 MHU
- Minimum scan time for all types of examination: 0.35 seconds
- Minimum slice thickness: 0.625 mm
- Open design concept with aperture diameter of 750 mm
- Unique laterally moving patient table
- New algorithms for iterative reconstruction: Intelli IP Advanced
- 475 mm wide patient table with weight limit of 230 kg

# SOMATOM Definition Edge brings Dual Energy to routine CT Imaging

With the new version of the SOMATOM Definition Edge, Siemens Healthcare has created the basis for establishing the dual energy procedure in clinical routine. The innovative X-ray tube concept in the new CT scanner, enables simultaneous imaging at two different energy levels for the first time in single source computed tomography. Thanks to a novel user- and patient-friendly measurement method, information on tissue and other material can be obtained as well as traditional morphological data, even during examinations with high contrast media dynamics. This means that more patients will benefit from the added value of dual energy imaging.

## Single Source Dual Energy – how it works

In dual energy imaging, the same region of the body is examined using two different energy levels. The two datasets offer more detailed information about tissue composition that goes beyond pure morphology. For instance, metal artifacts caused by implants such as artificial hips are reduced considerably, while tissue and bone structures can be displayed more clearly. However, in cases

where data have been acquired using fast kV-switching or dual layer detector technology – dual energy imaging involved significant drawbacks. Single source dual energy images acquired with these methods were excluded for many important radiological use cases, because the tube does not emit the two energy spectra at the same time, only in succession through rapid switching or through spectra separation at the detector side after penetrating the patient. With kV-switching, the segmentation of the measuring points significantly impairs the image quality due to the limited data per energy level. At the same time, increased X-ray doses are inevitable because the dose cannot be modulated to reduce radiation.

## New source design splits the X-Ray Beam into two energy spectrums

Not so with the TwinBeam Dual Energy technology from Healthcare, in which the X-ray beam emitted is split into two different energy spectra before reaching the patient thanks to an innovative tube design. This means that the SOMATOM Definition Edge generates the dual energy images at the same time.

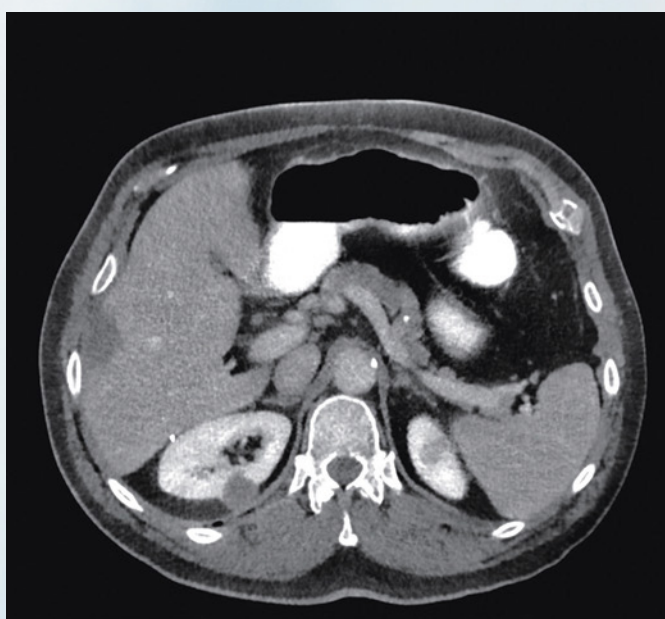

A control study of a liver metastasis after microwave ablation treatment: A monoenergetic image at 50 keV (left) and a fused virtual non-contrast (VNC) / iodine image (right) show a hypodense lesion in the liver and in the right kidney.

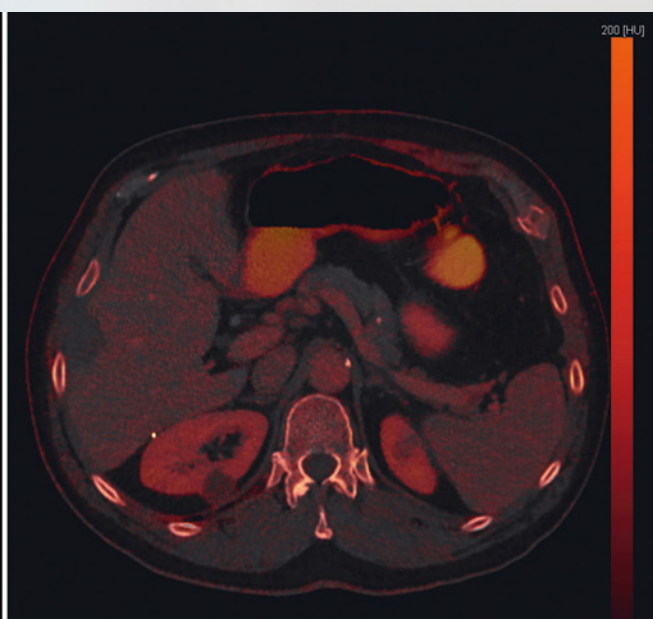

The image contrast is greatly increased by monoenergetic imaging. And both lesions show no significant enhancement in the fused VNC / iodine image, therefore, residual tumor tissue can be confidently excluded and a kidney cyst can be diagnosed. © University Erlangen-Nuremberg, Erlangen, Germany





**With the new version of the SOMATOM Definition Edge, Siemens Healthcare has created the basis for establishing the dual energy procedure in clinical routine. The innovative X-ray tube concept in the new CT scanner enables simultaneous imaging at two different energy levels for the first time in single source computed tomography.**

The benefits of the new procedure are illustrated by the diagnostics in a case of suspected pulmonary embolism: Due to the improved tissue differentiation and the precise representation of contrast media distribution, vascular occlusions can be quickly identified and their size determined.

In addition to increasing the diagnostic strength of clinical images, TwinBeam technology also minimizes the X-ray dose required in a different way to other single source dual energy procedures. All dose-reducing Siemens technologies can be used with the SOMATOM Definition Edge. This now also includes ADMIRE, the model-based iterative reconstruction procedure which was just recently released on the SOMATOM Force and whose scanner-specific algorithms can reduce X-ray doses further still – achieving excellent image resolution and extremely low image noise even at low doses.

### Iterative metal artifact reduction for clearer material differentiation

To further improve not only the quality of dual energy examinations, but also of conventional CT scans, Siemens Healthcare is additionally introducing a new iterative algorithm for metal artifact reduction with the new SOMATOM Definition Edge: iMAR. This allows respective artifacts – caused by implants, artificial joints or pacemakers – to be reduced significantly. Such artifacts may lead in the worst case to non-diagnostic images by concealing the relevant pathologies.

Even if a radiologist wishes to check whether bone fractures have healed and metal objects such as screws and plates can be removed, the iMAR algorithm can be used to clearly assess the anatomical details in the area of transition between bone and metal. With the aid of iMAR, streak artifacts can, for instance, be significantly reduced in clinical images, according to first scientific results.

*The products/features (here mentioned) are not commercially available in all countries. Due to regulatory reasons their future availability cannot be guaranteed. Further details are available from the local Siemens organizations. [www.siemens.com/healthcare](http://www.siemens.com/healthcare)*

# COMPUTED TOMOGRAPHY

## VOLUME CTS

### Siemens · SOMATOM Definition Edge

<b>Acquired slices / rot</b>	128
<b>Power</b>	Up to 100 kW
<b>Gantry bore</b>	78 cm
<b>Dual Energy</b>	Yes



#### Highlights

- 0.28 s rotation speed
- Revolutionary Stellar detector: 0.50 mm slices for 0.30 mm spatial resolution
- STRATON tube with z-Sharp and 70 kV imaging
- Raw-data based iterative reconstruction (ADMIRE)
- TwinBeam Dual Energy
- iMAR (iterative Metal Artifact Reduction)
- Dynamic imaging of up to 48 cm

### Siemens · SOMATOM Definition AS (128-slice AS+ configuration)

<b>Acquired slices / rot</b>	128
<b>Power</b>	Up to 100 kW
<b>Gantry bore</b>	78 cm
<b>Dual Energy</b>	Yes



#### Highlights

- Rotation time of up to 0.3 s and 0 MHU STRATON tube with 70 kV
- Workflow optimization for more reliable and reproducible scanning with FAST CARE technology
- Automated kV setting with CARE kV
- TwinBeam Dual Energy and iMAR (iterative Metal Artifact Reduction)
- Raw-data based iterative reconstruction (SAFIRE) with up to 20 images / s
- 3D-guided intervention, upgradeable to Stellar detector

### Siemens · SOMATOM Perspective (64- and 128-slice configuration)

<b>Slices per rotation</b>	64 / 128
<b>Power</b>	55 kW (112 kW equivalent)
<b>Temporal resolution</b>	195 ms with iTRIM (120 ms bi-segment)
<b>Dual Energy</b>	Yes



#### Highlights

- Unique eCockpit suite and innovative service for lower TCO
- Raw-data based iterative reconstruction (SAFIRE) for up to 60 % dose reduction
- FAST solutions to make time-consuming and complex procedures faster and far more intuitive
- Efficient gantry design with Illumination Moodlight and an extremely short focal spot to isocenter distance
- iMAR (iterative Metal Artifact Reduction) and Dual Energy

### Toshiba · Aquilion ONE ViSION Edition

<b>Coverage per rotation</b>	16 cm
<b>Slices per rotation</b>	640
<b>Slice thickness</b>	0.5 mm
<b>Rotation speed</b>	0.275 s



#### Highlights

- PUREViSION detector
- 78 cm bore
- 2 mm @ 3HU LCR
- 300 kg patient load table
- Lateral table movement (option)
- AIDR 3D iterative reconstruction
- Adaptive Diagnostics
- SEMAR (Metal Artifact Reduction)
- Sub mSv Cardiac
- Arrhythmia scanning
- Isophasic organ perfusion
- UltraHelical
- Dual Energy at 50 cm FOV (option)

### Toshiba · Aquilion ONE

<b>Coverage per rotation</b>	16 cm
<b>Slices per rotation</b>	640
<b>Slice thickness</b>	0.5 mm
<b>Rotation speed</b>	0.35 s



#### Highlights

- PUREViSION detector
- Upgradeable to 0.275 s per rotation
- 78 cm bore
- 2 mm @ 3 HU LCR
- 300 kg patient load table
- Lateral table movement (option)
- AIDR 3D iterative reconstruction
- Adaptive Diagnostics
- SEMAR (Metal Artifact Reduction)
- Sub mSv Cardiac
- Arrhythmia scanning
- Isophasic organ perfusion
- UltraHelical
- Dual Energy at 50 cm FOV (option)

### Toshiba · Aquilion PRIME

<b>Coverage</b>	40
<b>Slices per rotation</b>	80 / 160
<b>Slice thickness</b>	0.5 mm
<b>Rotation speed</b>	0.35 s



#### Highlights

- PUREViSION detector
- 78 cm bore
- 2 mm @ 3 HU LCR
- 300 kg patient load table
- Lateral table movement (option)
- AIDR 3D iterative reconstruction
- Iterative bolus tracking
- Iterative 3D Fluoro (option)
- Adaptive Diagnostics
- SEMAR (Metal Artifact Reduction)
- Low dose Helical Cardiac Prospective scanning (option)
- Dual Energy at 50 cm FOV (option)
- 14.8 m<sup>2</sup> installation space



# We stand behind our products



For over 84 years, our experienced team has focused on providing you with the highest quality products.

We are dedicated to continuing this tradition for many years to come.

OEM Imaging Components | Grids | Replacement Tubes  
[www.dunlee.com](http://www.dunlee.com) | [www.smitroentgen.com](http://www.smitroentgen.com)

**PHILIPS**

**DUNLEE** **smit**  
RÖNTGEN



Toshiba reduces radiation dose in cardiac CT by 40 percent

# New technology allows scanning everyone

An independent survey conducted by the British Society of Cardiac Imaging (BSCI) yielded surprising results: Not only does Toshiba's Aquilion ONE scanner deliver ultra-low radiation doses for cardiac CT, its next-generation PUREVISION detector also widens the scope of diagnostic cardiac CT. Radiologists agree that this innovative technology allows scanning of patients who previously would never have been considered for CT.

## Incredibly 40 percent lower radiation dose

"This data is possibly the most powerful evidence I can present in favor of the Aquilion ONE with the PUREVISION detector," says Dr. Russell Bull, Consultant Radiologist at the Royal Bournemouth Hospital in Dorset, UK, where the data for this study was collected. The survey, which was conducted over a period of one month, covered an unselected patient population at the Royal Bourne-



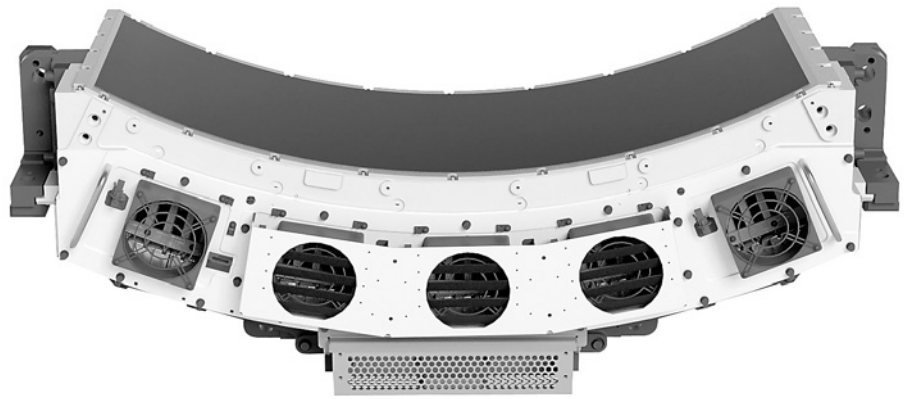

**Toshiba's revolutionary PUREVISION detector makes CT imaging safer for all patients. Delivering up to 40 % increased efficiency it enables superior imaging with significantly reduced radiation dose and iodine.**

images at 40 percent less radiation dose. With Aquilion ONE we can scan patients we wouldn't even consider scanning on a conventional scanner."

there was a 40 percent reduction in dose. This is extraordinary as the Aquilion ONE already stood out as a low-dose scanner in the previous survey."

**4D imaging and more enhancements**

With the Aquilion ONE CT scanner time can be added as the fourth dimension paving the way for high-quality dynamic volume applications, or 4D dynamic volume imaging. Each individual set of data, acquired in a dynamic volume, shows an exact moment in time, or the exact phase of contrast enhancement. Also unique to Toshiba, Dr. Bull underlines, is the ability to change the table speed on the fly with Variable Helical Pitch (vHP). This facilitates for example a TAVI scan as it saves time and contrast dose, while reducing radiation dose for the patient.

**Better imaging with high contrast**

Adaptive Iterative Dose Reduction in 3D (AIDR 3D) is integrated in the Aquilion VISION. It minimizes image noise thereby enabling radiologists to lower the radiation dose while maintaining high diagnostic image quality.

In combination with the wide detector array of 16 cm, the Aquilion VISION provides volumetric scanning with entire organs being captured with perfect temporal uniformity and completely free from z-axis misregistration at a rotation speed of 0.275 seconds.

"We have no problems with patients unable to lie flat or having ridiculously high heart rates or even atrial fibrillation. These can be scanned, perfectly showing coronary arteries at low dose," he notes. "This really works. We can scan anyone."

Dr. Bull summarizes "The image quality has improved even further due to the combination of the PUREVISION detector and AIDR 3D processing. We are seeing better

[www.toshiba-medical.eu](http://www.toshiba-medical.eu)

mouth Hospital, including those with atrial fibrillation and high body mass index. The radiation dose of around 1mSv for an unselected population is amongst the lowest ever recorded for cardiac CT.

"I would have been happy with a 20 percent reduction in radiation dose compared to the previous survey," Dr. Bull reported when presenting the BSCI findings. "In fact

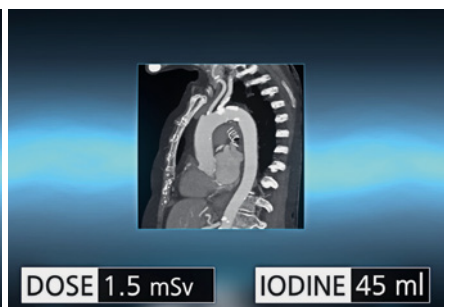
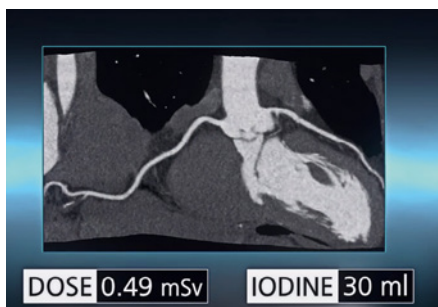

# COMPUTED TOMOGRAPHY

## 20 TO 64 SLICES

### GE Healthcare · Optima CT660S

<b>Channels</b>	64
<b>Coverage</b>	40 mm isotropic, 64i – 0.625 mm (overlap), 32i – 0.625 mm, 16i – 1.25 mm, 8i – 2.5 mm, 4i – 5 mm, 2i – 10mm
<b>Rotation</b>	0.4 s (cardiac 0.35 s)

#### Highlights

- 64 and 128 slices imaging
- Latest innovations in a 40 mm detector CT
- Leadership in advanced cardiac CT
- Intelligent cardiac CT with Snapshot
- Assist and Snapshot Freeze
- Real time recon (55 fps)
- Fast acquisitions with high helical pitch (1.531)
- Automatic reconstruction with 10 PMR
- Up to 500 slices coverage for perfusion
- 60% lower CO<sup>2</sup> emission and energy saving
- Scalable and modular
- Compact for easy siting (18 sqm)
- Integrated ASiR reconstruction



### Siemens · SOMATOM Definition AS (64-slice configuration)

<b>Slices per rotation</b>	64
<b>Power</b>	Up to 100 kW
<b>Gantry bore</b>	78 cm
<b>Dual Energy</b>	Yes

#### Highlights

- Rotation time of up to 0.3 s and 0 MHU STRATON tube with 70 kV
- Workflow optimization for more reliable and reproducible scanning with FAST CARE technology
- Automated kV setting with CARE kV
- 3D-guided intervention
- Raw-data based iterative reconstruction (SAFIRE) with up to 20 images/s
- iMAR (iterative Metal Artifact Reduction) and Dual Energy
- Special configuration for dedicated radiation therapy planning
- Fully onsite upgradeable to 128 slices with Stellar detector



### Siemens · SOMATOM Definition AS (20- and 40-slice configuration)

<b>Slices per rotation</b>	20 / 40
<b>Power</b>	80 kW
<b>Gantry bore</b>	78 cm
<b>Dual Energy</b>	Yes

#### Highlights

- Rotation time of up to 0.33 s and 0 MHU STRATON tube with 70 kV
- Workflow optimization for more reliable and reproducible scanning with FAST CARE technology
- Automated kV setting with CARE kV
- Raw-data based iterative reconstruction (SAFIRE) with up to 16 images/s
- iMAR (iterative Metal Artifact Reduction) and Dual Energy
- 3D-guided intervention
- Fully onsite upgradeable to 128 slices with Stellar detector



### Siemens · SOMATOM Perspective (16- and 32-slice configuration)

<b>Slices per rotation</b>	16 / 32
<b>Power</b>	55 kW (112 kW equivalent)
<b>Temporal resolution</b>	195 ms with iTRIM (120 ms bi-segment)
<b>Dual Energy</b>	Yes

#### Highlights

- Unique eCockpit suite and innovative service for lower TCO
- Raw-data based iterative reconstruction (SAFIRE) for up to 60% dose reduction
- FAST solutions to make time-consuming and complex procedures faster and far more intuitive
- Efficient gantry design with Illumination Moodlight and an extremely short focal spot to isocenter distance
- iMAR (iterative Metal Artifact Reduction) and Dual Energy



### Toshiba · Aquilion RXL

<b>Rotation speed</b>	0.5 s
<b>Coverage per rotation</b>	3.2 cm
<b>Slices per rotation</b>	16 / 32
<b>Slice thickness</b>	0.5 mm

#### Highlights

- PUREVISION detector
- Upgradeable to 0.4 s rotation
- 72 cm bore
- 2 mm @ 3 HU LCR
- AIDR 3D iterative reconstruction
- Dose check and report
- SURECardio, low dose cardiac (option)
- CT DSA with SURESubtraction (option)
- SUREFluoro for intervention procedures (option)
- SUREXtension, remote access (option)
- Reduced energy consumption



### Toshiba · Astelion Advance Edition

<b>Rotation speed</b>	0.75 s
<b>Coverage</b>	2.0 cm
<b>Slices per rotation</b>	16 / 32
<b>Slice thickness</b>	0.5 mm

#### Highlights

- Upgradeable to 0.6 s rotation
- 72 cm bore
- 2 mm @ 3 HU LCR
- AIDR 3D iterative reconstruction
- Navi Mode Operation for fast patient throughput
- CT DSA with SURESubtraction (option)
- SUREFluoro for intervention procedures (option)
- 2.9 ton/year reduction of CO<sub>2</sub> emission
- Minimized energy consumption
- Minimum foot print of 10.4 m<sup>2</sup>



**Toshiba · Aquilion Lightning**

**Coverage per rotation** 2.0 cm  
**Slices per rotation** 16/32  
**Slice thickness** 0.5 mm  
**Rotation speed** 0.75 s



**Highlights**

- PUREVISION detector
- Upgradeable to 0.6 s fast rotation
- 78 cm bore
- 2 mm @ 3HU LCR
- AIDR 3D iterative reconstruction
- Adaptive Diagnostics
- vHP (option)
- SEMAR (Metal Artifact Reduction)
- Navi Mode Operation for fast patient throughput
- CT DSA with SURESubtraction (option)
- SUREFluoro for intervention procedures (option)
- Minimized energy consumption
- Minimum foot print of 10.4 m<sup>2</sup>

**2 TO 16 SLICES**

**GE Healthcare · Optima CT540**

**Rotation** 0.5 sec  
**Channels** 16



**Highlights**

- It helps to answer your need for exceptional clinical results, a steadily increased volume of patient throughput, a focus on patient-centered tasks, and a reduction in unnecessary steps and tedious, time-consuming operations.
- Moreover it is designed to provide a reliable CT solution for high quality diagnostic imaging at lower dose in:  
 Oncology / Angiography / Interventional / Emergency

**GE Healthcare · Optima CT520**

**Channels** 16



**Highlights**

- Designed to help healthcare providers deliver the best patient care with customer inspired enhancements including:
- Superb image quality
  - Advanced dose optimizing features
  - Streamlined workflow
  - Technological innovations
  - Built on reliable and proven technology, the Optima CT520 combines advanced clinical capacity with economic value



24 m<sup>2</sup> with 80 km/h

**MOBILE MRI**

-269 °C and 1,5 Tesla



**LEADING INDEPENDENT SPECIALIST FOR MOBILE MEDICAL IMAGING**

**INTERIM SERVICE**

Interim Service ensures continuity of your diagnostic imaging department during downtimes

**ROUTE SERVICE**

Routing Service of mobile MRI, CT, PET/CT, ESWL and SBB

**MODULAR BUILDING**

Providing custom build modular buildings for MRI, CT, PET, PET/CT

**PRE-OWNED**

Please ask us about our preowned equipment (e.g. MRI, CT, PET, PET/CT) or provide us your old system to purchase

[www.alliancemedical.de](http://www.alliancemedical.de)



## 2 TO 16 SLICES

### Hitachi · SUPRIA 16

<b>Gantry bore</b>	75 cm
<b>Field of View</b>	500 mm
<b>Slice thickness</b>	0.675 mm
<b>Slices per rotation</b>	16



#### Highlights

- 5 MHU X Ray tube
- Sub second scan time for all examinations
- 0.675 mm minimum slice thickness
- 75 cm wide gantry bore for improved patient experience
- The compact footprint needs small installation space
- New Iterative reconstruction algorithm for low dose examinations
- Intuitive GUI design with 24-inch wide monitor

### Siemens · SOMATOM Emotion (16-slice configuration)

<b>Slices per rotation</b>	16
<b>Power</b>	50 kW
<b>System Footprint</b>	8 m <sup>2</sup>
<b>Installation Area</b>	18 m <sup>2</sup>



#### Highlights

- Runs with the award winning FAST CARE technology, providing new features such as FAST Planning and FAST Spine
- Fast for diagnosis, with its post-processing capabilities
- Installed at nearly 9,000 institutes around the world; famous for its high versatility and high performance
- Fabulous for its leading image quality, with the great routine spatial resolution and very small focal spot
- Fabulous leading dose technology with CARE Dose4D and Iterative reconstruction (IRIS)

### Siemens · SOMATOM Scope

<b>Slices per rotation</b>	16/32
<b>Power</b>	26/50 kW
<b>System Footprint</b>	8 m <sup>2</sup>
<b>Installation Area</b>	12 m <sup>2</sup>



#### Highlights

- Leading image quality from high-quality UFC detector material and very small focal spot
- Outstanding image quality, at the right dose with CARE Dose4D and iterative reconstruction (IRIS and SAFIRE)
- iMAR (iterative Metal Artifact Reduction) and Dual Energy
- Optimized total cost of ownership due to reduced overhead costs and extended scanner lifetime with eCockpit

### Siemens · SOMATOM Spirit

<b>Slices per rotation</b>	2
<b>Spatial resolution</b>	15.5 Lp/mm



#### Highlights

- Easy user interface provides simplicity and a fast learning curve
- Outstanding overall system uptime due to robust design and stability
- Exceptional patient throughput-to-investment ratio
- Low heat dissipation and power consumption
- Real-time dose modulation with CARE Dose4D for up to 68% dose reduction
- Increased volume coverage with gantry rotation speed of up to 0.8 s

**Buy & sell used equipment on**



[www.dotmed.com](http://www.dotmed.com)

**Over 400,000 listings**  
**Over 20,000 daily visitors**

## ONCOLOGY CT

### GE Healthcare · Discovery CT590 RT

<b>Channels</b>	16
<b>Coverage</b>	16 x 0.625 or 16 x 1.25
<b>Rotation</b>	0.5 s



#### Highlights

- Wide bore geometry (80 cm)
- GE MicroVoxel technology
- Biopsy and interventional modes obese patient capability up to 295 kg
- All tables TG 66 compliant (225 and 295 kg max)
- Up to 40% dose reduction across the body with integrated ASiR reconstruction
- 4D gating reconstruction on the operator console
- Complete and easy to use RT simulation planning solution with SIM MD on AW

**GE Healthcare · Optima CT580 Series**

<b>Channels</b>	8 or 16
<b>Coverage</b>	8 x 1.25 or 8 x 2.516 x 0.625 or 16 x 1.25
<b>Rotation</b>	0.8 or 0.5 s



**Highlights**

- Wide bore geometry (80 cm)
- GE MicroVoxel technology
- Biopsy and interventional modes obese patient capability up to 295 kg
- All tables TG66 compliant (225 and 295 kg max)
- Up to 40% dose reduction across the body with integrated ASiR reconstruction
- 4D gating reconstruction on the operator console
- Complete and easy to use RT simulation planning solution with SIM MD on AW

**Siemens · SOMATOM Definition AS Open – RT Pro edition**

<b>Slices per rotation</b>	20/64
<b>Power</b>	Up to 100 kW
<b>Gantry bore</b>	80 cm
<b>Dual Energy</b>	Yes



**Highlights**

- Leading image quality resulting from high-quality UFC detector material and iterative reconstruction.
- Improved visualization thanks to iMAR and extended field of view of 80 cm
- Comprehensive tumor motion management solution
- Ready for new treatment techniques requiring higher accuracy
- Improved process efficiency with a workflow guided RT solution

Discover the  
**POWER**  
of **CBCT**

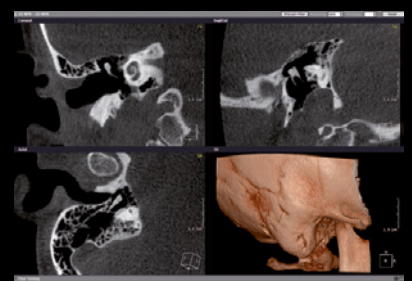
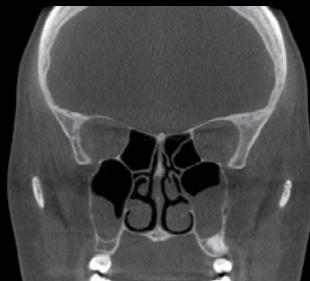

**SOREDEX**  
www.soredex.com

See you at ECR, Vienna! Hall Expo C, Booth nr. 313

# COMPUTED TOMOGRAPHY

## ONCOLOGY CT

### Siemens · SOMATOM Scope Power

<b>Slices per rotation</b>	16
<b>Power</b>	50 kW
<b>System Footprint</b>	8 m <sup>2</sup>
<b>Installation Area</b>	12 m <sup>2</sup>

#### Highlights

- Leading image quality resulting from high-quality UFC detector material and iterative reconstruction.
- Improved visualization with an extended field of view of 70 cm
- More efficient examination procedures with the all-in-one workplace
- Comprehensive tumor motion management solution
- Optimized total cost of ownership due to reduced overhead costs and extended scanner lifetime with eCockpit



### Toshiba · Aquilion LB

<b>Rotation speed</b>	0.5 s
<b>Coverage per rotation</b>	3.2 cm
<b>Slices per rotation</b>	32
<b>Slice thickness</b>	0.5 mm

#### Highlights

- PUREVISION detector
- 90 cm bore
- 70 cm FOV
- 85 cm extended FOV
- 2 mm @ 3 HU LCR
- 300 kg patient load table
- AIDR 3D iterative reconstruction
- Respiratory gating (option)
- Oncology table top (option)
- CT DSA with SURESubtraction (option)
- SUREFluoro (option)
- Reduced energy consumption



## DIGITAL VOLUME TOMOGRAPHY

### Planmed Oy · Planmed Verity

<b>Scan volume</b>	16 cm diameter x 13 cm, 16 cm diameter x 7 cm
<b>Spatial resolution</b>	0.4 mm, 0.2 mm
<b>Scan time</b>	18 s

#### Highlights

- Cone Beam CT (CBCT) scanner dedicated to extremity and maxillofacial imaging
- kV range 80 – 96 kV
- High quality 3D-imaging with low dose
- Compact, mobile, easy to site
- Motorized, soft-surface gantry adapts to the patient
- TearDrop shaped bore with target specific positioning system
- Weight-bearing imaging



### SOREDEX · SCANORA 3D

<b>Scan volume</b>	60x60 mm – 130x145 mm
<b>Voxel size</b>	0.133 – 0.35 mm
<b>Scan time</b>	11 – 26 s

#### Highlights

- SCANORA 3D is a fast, easy to use and low dose CBCT imaging system for Head and Neck area. The FOV size (from 6x6 cm up to 13x14,5 cm) and protocol are user selectable according to the diagnostic task. The FOV can be freely located in the skull area thanks to motorized positioning movements and laser lights. Available with optional dedicated sensor for panoramic imaging. Low maintenance costs.



### SOREDEX · SCANORA 3Dx

<b>Scan volume</b>	50x50 mm – 240x165 mm
<b>Voxel size</b>	0.1 – 0.5 mm
<b>Scan time</b>	18 – 34 sec.
<b>System Footprint</b>	187x187 cm

#### Highlights

- SCANORA 3Dx is a large field-of-view Cone Beam CT imaging system for head and neck. The FOV sizes (from 50x50 mm up to 240x165 mm) and protocol are user selectable according to the diagnostic task. The FOV can be freely located to the region of interest thanks to motorized positioning movements of the integrated chair. The system is available with optional RealPAN dental panoramic imaging.



### VILLA SISTEMI MEDICALI · Rotograph Evo 3D

<b>Scan volume</b>	85 x 85 mm
<b>Voxel size</b>	166 µm
<b>Scan time</b>	11.2 s (exposure)

#### Highlights

- 3-in-1 dental system with "Cone Beam" technology
- Pan-3D detector always ready to operate: no need to switch it from Pan to 3D mode
- Can be integrated with Cephalometric arm
- Optional Evo Xp Examination Module enlarges the traditional Panoramic views
- Accessible to any patient, including ones on wheelchairs
- Reconstruction time as low as 45 s



# Buy & sell used equipment on



[www.dotmed.com](http://www.dotmed.com)

**Over 400,000 listings**  
**Over 20,000 daily visitors**

## ACCESSORIES / COMPLEMENTARY SYSTEMS

### Toshiba Electron Tubes & Devices · CT Tube assembly



#### Highlights

- For CT systems (2-MHU to 4-MHU)
- Uses a liquid metal bearing
- Supports 0.6 s full scans
- Our unique liquid metal bearing technology uses an all-metal target, enabling high anode heat dissipation with low noise and long bearing life.

### Alliance Medical · Flexible diagnostic imaging services



#### Highlights

- Static diagnostic imaging centers MRI, CT, PET, PET / CT
- Interim services for bridging downtimes
- Regular "routing" services

### Alliance Medical · Modular building solutions



#### Highlights

- Engineering, rental, sale of modular buildings MRI, CT, PET, PET / CT including or excluding diagnostic equipment

### Dunlee · CT Replacement Tubes



#### Highlights

- Replacement tubes for more manufacturers than any other company in the industry (GE, Siemens, Toshiba, Shimadzu, Philips, Elscint or Picker)
- 24/7 – 365 days per year
- Tube stocks at major airport hubs throughout the United States, Asia, Europe and Latin America
- Shipment of most popular replacement tubes, typically with same-day or next-day delivery

### Dunlee · Smit Röntgen 3D Printed Tungsten Parts

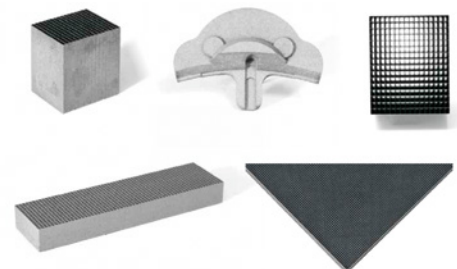

#### Highlights

Smit Röntgen offers pure Tungsten products made by Direct Metal Laser Sintering. With this unique and patented technology free form parts made out of pure tungsten can be made.

#### Applications

- Collimators for Molecular Breast Imaging and SPECT
- Dedicated X-ray shieldings and collimation parts
- CT anti-scatter grids
- X-ray tube parts
- Breakthrough freedom of design
- Eco friendly technology



## ACCESSORIES / COMPLEMENTARY SYSTEMS

### Dunlee · Smit Röntgen CT Ceramic GOS Scintillator

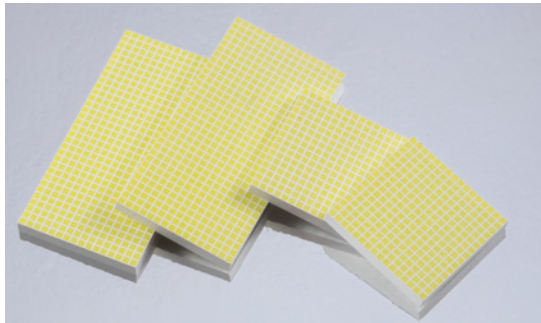

#### Highlights

- Optimal image quality through high light output
- Extremely low afterglow  
Typical values:  
– 150 ppm after 3 ms  
– < 5 ppm after 300 ms
- Very high transparency (enabler for high definition)
- Maximum emission at 515 nm
- Maximum outer dimensions: 7 x 7 cm<sup>2</sup>
- Slot width 100 µm
- Minimum pixel size: 0.5 x 0.5 mm<sup>2</sup>

### GCTechnology · CIRS Phantoms

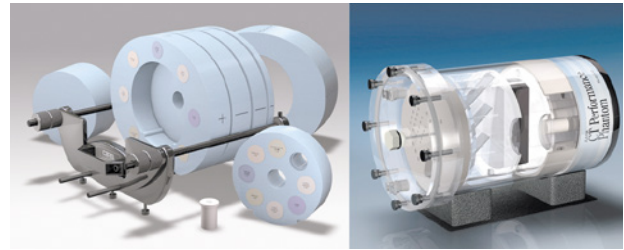

#### Highlights

- Electron density phantom family for diagnostic and CBCT
- CT dose phantoms
- Plastic water and tissue equivalent materials
- Bone analysis CT simulator
- Spiral / helical CT phantom
- AAPM CT performance phantom
- 3D sectional torso Phantom
- Head phantoms

### mediCAD – hectec · mediCAD hybrid 3D



#### Highlights

This new module opens up a whole new world for planning doctors. Now you can use CT or MRT images to plan in three dimensions. With fully automated recognition of all present vertebrae and segments, mediCAD 3D provides you with active support while performing a wide variety of measurements. Also available our 3D hip and trauma planning solution in 2015.

### I.A.E. · RTC 165



#### Highlights

- Replacement for GE Scanners: Sytec 6,000 / 8,000 Prospeed, Hispeed Dxi, Fxi, Lxi CT / i Advantage.
- Reloaded in original CT Housing
- Careful refurbishing of original casing
- Replacing of all wear subject components
- Special cathode processing for reliable current emission
- Controlled thickness window for consistent HVL

### Varian · MCS 6074 Replacement Tube

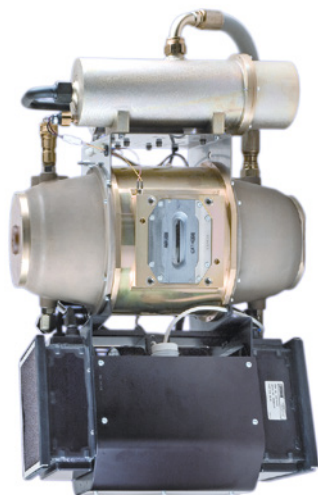

#### Highlights

- Replacement for Performix 6.3 mHU CT tube
- Designed for GE Lightspeed and Brightspeed family of scanners
- Calibrates like the original
- Supports 0.5 second full scans
- Long life bearing

### Varian · MCS 8064 Replacement Tube



#### Highlights

- Replacement tube for GE Lightspeed VCT
- Installs and calibrates like the original
- Over 30,000 anode end grounded (AEG) tubes sold
- Designed with Varian's 20+ years of experience



# Magnetic Resonance Imaging

3 Tesla  
1.5 Tesla  
Open  
MR-PET  
Surgical MRI  
MRT Coils  
Accessories /  
Complementary Systems



GCTechnology GmbH



Less noise, less energy and a small footprint

# Vantage Elan delivers premium MR performance

At last year's ECR Toshiba introduced the Vantage Elan 1.5 Tesla system with a lot of innovative features and new techniques, making it a pleasant and helpful new workhorse for small and large clinics. Since this introduction, the Vantage Elan has seen fantastic success in Europe because of the outstanding clinical and economic benefits it brings with advance technologies. The Elan offers outstanding image quality from head to toe thanks to advanced features included on Toshiba's premium-tier MR systems.

Toshiba unified lots of innovative details in the new Vantage Elan to achieve an optimal homogenous magnet field, being the key to high image quality. The quality of MR images depend on the homogeneity of the static magnetic field generated by the super-conducting magnet. The company therefore developed an Advanced Magnet system, a key technology which generates a highly homogenous static magnet field and ensures a wide scanning range and stable image quality.

Additionally the Advanced Gradient Shielded Coil System – a completely new concept – minimizes eddy current which results in clearer patient images. This works together with the unique gradient coil cutting technology that cuts high-purity copper ingots into 3D shapes at the micron level. This technology ensures excellent stability and highly effective eddy current suppression.

With images from the new Toshiba scanner surgeons now can see details they had not seen before. Even aortic images can be delivered in good quality. Usually the ankle joint cartilage cannot be seen, because it is quite narrow. With the Vantage Elan 1.5 this cartilage can be seen now, even the thin line showing the actual joint with cartilage above and below. This is what orthopedic surgeons want to know.

## Smallest footprint scanner in the world

With the development of the Vantage Elan, Toshiba not only looked to investment costs and running costs, but took the Total Costs of Ownership in consideration; such as: investment, maintenance, space requirements, installation requirements, electrical power connection, running costs, power consumption, cooling requirements and installation down time. Consequently the Vantage Elan has the smallest footprint of any scanner in the world and is engineered to deliver the lowest running costs. Setting-up is done within five days and saves time during the installation work. Energy-saving features built into the Vantage Elan reduce the total power requirement to

25 kVA, the lowest level in its class, resulting in significantly lower running cost. The maximum power consumption is approximately half that of previous scanners, which also contributes to cost reduction and environmental conservation. Also the Eco mode saves lots of energy. The Eco mode turns off parts of the system when it is not being used and can recover within one second and is ready to scan again. In sum costs for power requirements can be reduced by 68 % per year.

The new system also saves real estate costs for smaller institutions or community hospitals that need high-quality imaging systems with a smaller footprint. The minimum footprint of only 23 square meters, makes the Vantage Elan approximately 29 percent smaller than with previous 1.5T systems. The innovative redesign of the control cabinet means the MRT does not require a separate computer room. Even the heat generated by the Elan can be captured and used for heating an ecologically designed building or any other purposes.





**The Vantage ELAN requires a mere 23 square meters installation space**

### First time absolute silence in MRI

Generally MR Scanners are a source of permanent noise causing discomfort to patients and even more for the medical staff working with these systems all day long. Toshiba took this challenge as accepted and now, when the new Vantage Elan scanner is operating, one can close the door and it will be absolutely silent.

The usual noise generated during MRI scanning is caused by the vibration of the gradient coil. Therefore Toshiba invented its Pianissimo  $\Sigma^{\text{TM}}$  noise-reduction technology which results in a completely new kind of comfort for both – patients and operators. Pianissimo  $\Sigma^{\text{TM}}$  is a hardware solution that physically reduces noise. It is not software that requires reinventing all sequences. Because Pianissimo  $\Sigma^{\text{TM}}$  is engineered into the construction of the scanner, it reduces noise for every scan across the entire sequence list.

Toshiba's new technology puts patients at ease and addresses a major problem for people working with MRT.

### Optimal workflow through EasyTech and M-Power

The advanced M-Power interface from the Vantage Titan 3 Tesla scanner is now onboard the Vantage Elan, which includes the best positioning software for cardiac, neuro, and orthopedic imaging. The intuitive M-Power user interface improves productivity by simplifying exams with advanced post-processing tools.

So, it does not matter if the radiologist wants to do neuro, spine or cardio MRI, Easy Tech precisely recognizes target shapes and helps the clinician to set optimized scan planes. The calculation of the best settings is completed in a few seconds, which clearly improves examination workflow.

Due to EasyTech, high quality examinations can be acquired even by less experienced operators. NeuroLine automatically measures and analyzes the shape of the brain, determines the optimal slice position in each plane, and displays them within seconds. So does SpineLine. It automatically measures and analyzes the shape of the spine, determines the positioning ROI in each plane, and displays them within seconds. With CardioLine, precise cardiac examinations become available in a short time, reducing the patients' and technologist tension and stress.

From patient registration to image reconstruction and transfer – a wide variety of applications can support scan positioning and parameter settings, increasing operational efficiency.

[www.toshiba-medical.eu](http://www.toshiba-medical.eu)



An FSE PD scan acquired with a 16 element flex coil

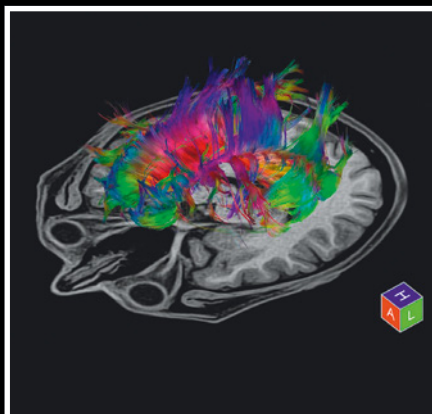

Tractography of the brain, acquired with a DTI scan in 49 directions



Time-SLIP of renal vessels, a non-contrast-enhanced MR angio technique



# MAGNETIC RESONANCE IMAGING

## 3 TESLA

**GE Healthcare · Discovery MR750 3.0 T**

<b>Gradient</b>	50 mT/m
<b>Slew rate</b>	200 T/m/s
<b>Channels</b>	32 / 128 (option)



**Highlights**

- Powerfully simple
- Express preparation exam
- “Can’t miss” applications and HD coils simply powerful
- Shorter TE/TR and faster acquisitions with unique gradients architecture
- Faster reconstruction
- 27% more SNR with optical RF technology

**GE Healthcare · Discovery MR750w 3.0 T**

<b>Gradient</b>	44 mT/m
<b>Slew rate</b>	200 T/m/s
<b>Channels</b>	32 / 128 (option)



**Highlights**

- Patient centric design
- 70 cm bore with full 50 x 50 x 50 cm FOV
- Geometry Embracing Method (GEM): lightweight and flexible coils, embedded posterior array, open face head/neck unit, feet first imaging
- Multi-drive RF transmit improves RF uniformity and signal homogeneity
- Optical RF – analog to digital-optical signal conversion

**GE Healthcare · Signa HDxt 3.0 T – Optima Edition**

<b>Gradient</b>	50 mT/m
<b>Slew rate</b>	150 T/m/s
<b>Channels</b>	Up to 32



**Highlights**

- Patient centric design
- 70 cm bore with full 50 x 50 x 50 cm FOV
- Geometry Embracing Method (GEM): lightweight and flexible coils, embedded posterior array, open face head/neck unit, feet first imaging
- Optical RF – analog to digital-optical signal conversion

**GE Healthcare · MRgFUS**

<b>Field</b>	1.5T / 3.0T
<b>Technology</b>	Combination of MR imaging and highly intense-ultrasound ExAblate 2,000 (InSightec)
<b>Clinical Application</b>	Uterine fibroids / bone tumors* / breast cancer* / liver tumors* / prostate cancer*



**Highlights**

- No radiation
- Visualizes and controls treatment by monitoring tissue effect real time
- Quick recovery, low rate of complications
- Limited conscious sedation (except for liver application general anesthetic; necessary)

*\* Investigational use*

**Siemens · MAGNETOM Spectra, A Tim+Dot System**

<b>Field strength</b>	3T
<b>Gradient</b>	33 mT/m
<b>Slew rate</b>	125 T/m/s
<b>Channels</b>	Up to 24



**Highlights**

- Outstanding image quality with Tim 4G technology
- Excellent usability and image consistency with Dot
- Comfortable and easy patient setup with SlideConnect & DirectConnect
- Low operating cost through low power consumption and zero helium boil-off
- Fast break even due to optimum TCO

**Siemens · MAGNETOM Verio, A Tim+Dot System**

<b>Field strength</b>	3T
<b>Gradient</b>	45 mT/m
<b>Slew rate</b>	200 T/m/s
<b>Channels</b>	Up to 32



**Highlights**

- Increased throughput with Tim+Dot
- Short, light, and easy to install 3T system
- Greater patient access and comfort with 70 cm Open Bore
- TrueForm design for optimized homogeneity volumes matching the true form of the human body



Beijing Wandong Medical has dedicated itself to the R&D, manufacture, sales and service of medical imaging equipment for 60 years. In addition to a wide sales and service network all over China, our export destination covers more than 70 countries. With strict production and quality management, our MRI systems and major X-ray equipment are ISO/CE/FDA/ACR approved. Over 6,000 units of X-ray equipment and 100 units MRI are manufactured annually.

The company philosophy, “Treasure Life, Ensure Health” , is our motivation to strive for advancement and innovation.

## 创新动力 品质为先



## 3 TESLA

### Siemens · MAGNETOM Skyra, A Tim+Dot System

<b>Field strength</b>	3T
<b>Gradient</b>	45 mT/m
<b>Slew rate</b>	200 T/m/s
<b>Channels</b>	Up to 128



#### Highlights

- Increase patient satisfaction with complete, quiet neurological and orthopedic exams
- High patient comfort with 70 cm Open Bore, quiet exams, and short system design
- Up to 50% higher productivity with Tim 4G and Dot\*
- Top-of-the-line applications and technologies for clinical routine and research
- DirectRF – digital in / out for high signal purity and improved stability
- Maximizing return due to minimized siting requirements and lower TCO through increased energy efficiency

\* Case Study Cardiac Dot Engine by: Dr. Russell Bull, Royal Bournemouth Hospital, UK

### Siemens · MAGNETOM Prisma, A Tim + Dot System

<b>Field strength</b>	3T
<b>Gradient</b>	80 mT/m
<b>Slew rate</b>	200 T/m/s
<b>Channels</b>	Up to 128



#### Highlights

- A unique design for MRI researchers
- Unique scanner technology in one package: benchmark 3T magnet; XR 80 / 200 gradients; advanced parallel transmit technology and Tim4G
- Pioneering research applications
- The platform for the newest advancements in 3T MRI

### Toshiba · Vantage Titan 3T

<b>Gradient</b>	30 or 45 mT/m
<b>Slew rate</b>	203 mT/m/ms
<b>Channels</b>	16 or 32 ch

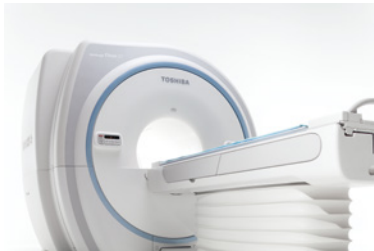

#### Highlights

- Patient friendly 71 cm open bore with 50x50x45 cm cylindrical scan area
- Multi phase transmit with 2 amp and 4 ports for homogeneous B1
- Pianissimo, acoustic noise reduction system
- Low couchtop of 43 cm for easy patient access
- Next generation of contrast-free angiography FBI, CIA, t-slip, TSA, HOP, FSBB
- Image recon. of up to 12,600 img/s
- M-Power intuitive graphical user interface

## 1.5 TESLA

### GE Healthcare · Discovery MR450 1.5T

<b>Gradient</b>	50 mT/m
<b>Slew rate</b>	200 T/m/s
<b>Channels</b>	32 / 128 (option)



#### Highlights

- Powerfully simple
- Express preparation exam
- “Can’t miss” applications and HD coils simply powerful
- Shorter TE/TR and faster acquisitions with unique gradients architecture
- Faster reconstruction
- 27% more SNR with optical RF technology

### GE Healthcare · Optima MR450w with GEM Suite

<b>Gradient</b>	34 mT/m
<b>Slew rate</b>	150 T/m/s
<b>Channels</b>	32 / 128 (option)



#### Highlights

- Patient centric design
- 70 cm bore with full 50 x 50 x 50 cm FOV
- Geometry Embracing Method (GEM): lightweight and flexible coils, embedded posterior array, open face head / neck unit, feet first imaging
- Optical RF – analog to digital-optical signal conversion

**Buy & sell used equipment on**



[www.dotmed.com](http://www.dotmed.com)

**Over 400,000 listings**  
**Over 20,000 daily visitors**





17240738834758843  
024546546  
02405465132132131  
032582642  
03755846

**SERVE PEOPLE,  
CARE FOR LIFE,  
LET MORE PEOPLE ENJOY HEALTH**



**NINGBO XINGAOYI MAGNETISM CO.,LTD**

Address:555 YESHAN RD.,YUYAO ZHEJIANG CHINA 315400

Tex:+86 574 6273 0899

Fax:+86 574 6273 0908

Website:www.china-mri.com

E-mail:zn301@vip.163.com

# MAGNETIC RESONANCE IMAGING

## 1.5 TESLA

### GE Healthcare · Optima MR360 Advance 1.5T

**Gradient** 33 mT/m  
**Slew rate** 120 T/m/s  
**Channels** 16



#### Highlights

- Homogeneous magnet  
 At the heart of the Optima MR360 Advance is our same proven, highly homogeneous magnet (typical ppm < 0.06 ppm @ 30 cm DSV)
- Optical RF (OpTix)  
 OpTix Optical RF technology offers high channel count, analog to digital-optical signal conversion. OpTix provides up to 27% higher signal-to-noise ratio (SNR)

### GE Healthcare · Signa HDxt 1.5T – Optima Edition

**Gradient** 33 mT/m  
**Slew rate** 120 T/m/s  
**Channels** 8/16/32



#### Highlights

- Patient centric design
- 70 cm bore with full 50 x 50 x 50 cm FOV
- Geometry Embracing Method (GEM): lightweight and flexible coils, embedded posterior array, open face head/neck unit, feet first imaging
- Optical RF – analog to digital-optical signal conversion

### GE Healthcare · Optima MR360 1.5T

**Gradient** 33 mT/m  
**Slew rate** 100 T/m/s  
**Channels** Up to 16



#### Highlights

- Remarkable flexibility and efficiency to match a wide range of imaging needs
- High image quality and lower total cost of ownership
- Technologists benefit from ease of use and confidence
- Radiologists benefit from expanded diagnostic capabilities administrators benefit from more satisfied patients, efficient throughput, and opportunities for growth

### GE Healthcare · Brivo MR355 Inspire 1.5T



#### Highlights

- Optical RF (OpTix)  
 OpTix Optical RF technology offers high channel count, analog to digital-optical signal conversion. OpTix provides up to 27 percent higher signal-to-noise ratio (SNR)
- Usable FOV  
 At the heart of the Brivo MR355 Inspire is our same proven, highly homogeneous magnet (typical ppm < 0.06 ppm @ 30 cm DSV)

### GE Healthcare · Signa HDx 1.5T

**Gradient** 23 mT/m  
**Slew rate** 50 T/m/s  
**Channels** 8



#### Highlights

- Compact MR design – only 25 m<sup>2</sup> siting space
- Low operating costs – 25% less than other 1.5 T systems
- High fidelity gradients to achieve accurate gradient pulses
- Broad range of high density coils for all applications
- Exclusive HD applications
- Consumes 41% less energy than previous generation systems, GE

### GE Healthcare · Optima PET/CT 560

**Resolution** 4 mm @ 1 cm Trasaxial  
**Sensitivity** 6.5 cps/kBq  
**FOV** 70 cm

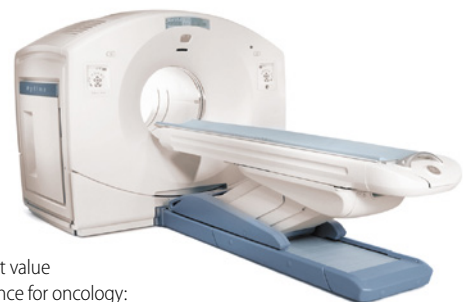

#### Highlights

- Solution offering excellent investment value with high performance for oncology:
- 2011 Frost and Sullivan “Price Performance Value Leadership award in PET”
  - Head to toe scanning – Low dose1
  - Sensitivity and high definition imaging
  - Simple user interface and real time visualization
  - Full diagnostic CT, upgradeability, GE service and reliability
  - BGO detector design

Hitachi · ECHELON

**Gradient** 33 mT/m  
**Slew rate** 150 T/m/s  
**Channels** Up to 16



**Highlights**

- Short bore, low running costs HF MRI system
- High magnetic field homogeneity
- Dedicated technology and sequences for artefacts suppression, very effective fat suppression / separation
- Scalable RF system
- Low cryogen boil-off technology

Hitachi · ECHELON OVAL

**Gradient** 34 mT/m  
**Slew rate** 150 T/m/s  
**Channels** 16



**Highlights**

- Revolutionary design featuring a 74 cm spacious OVAL environment
- Shaped around the human body
- Workflow Integrated Technology (WIT)
- WIT RF Coil System
- WIT Mobile Table
- WIT Patient information Monitor

Siemens · MAGNETOM ESSENZA, A Tim+Dot System

**Field strength** 1.5T  
**Gradient** 30 mT/m  
**Slew rate** 100 T/m/s  
**Channels** Up to 16

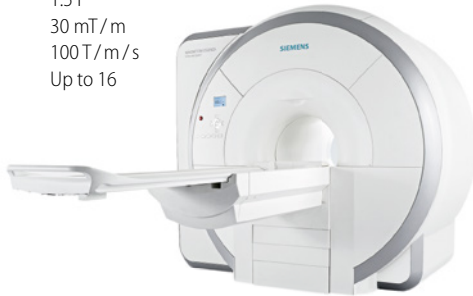

**Highlights**

- Increase patient-satisfaction with light-weight coils and ultra-short magnet design
- Increased throughput, consistency, and ease of use – with Dot
- Greater clinical scope with standard and advanced clinical applications
- Low operating cost through low power consumption and zero helium boil-off
- Fast break even due to optimum TCO

Siemens · MAGNETOM Amira, A Tim+Dot System

**Field strength** 1.5T  
**Gradient** 33 mT/m  
**Slew rate** 125 T/m/s  
**Channels** Up to 24



**Highlights**

- Increase patient satisfaction with complete, quiet neurological and orthopedic exams
- Right Timing and motion insensitive techniques for liver exams with FREEZEit
- 10-min exams with best-practice-based protocols
- Up to 30% energy savings in standby mode with Eco-Power
- Increased throughput with Tim 4G and DotGO
- Maximizing return due to minimized siting requirements and costs

*The product is currently under development; it is not for sale in the U.S. and other countries. Its future availability cannot be guaranteed.*

Siemens · MAGNETOM Avanto, A Tim+Dot System

**Field strength** 1.5T  
**Gradient** 45 mT/m  
**Slew rate** 200 T/m/s  
**Channels** Up to 32



**Highlights**

- Increased throughput with Tim+Dot
- Exceptional magnet homogeneity for excellent fat saturation
- Fast training and increased staff versatility
- Broad application range
- Easy siting conditions

Siemens · MAGNETOM Aera, A Tim+Dot System

**Field strength** 1.5T  
**Gradient** 45 mT/m  
**Slew rate** 200 T/m/s  
**Channels** Up to 64

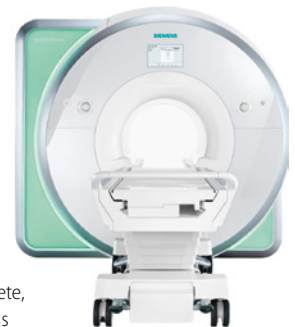

**Highlights**

- Increase patient satisfaction with complete, quiet neurological and orthopedic exams
- High patient comfort with 70 cm Open Bore in combination with ultra-short system design (145 cm cover to cover)
- Up to 50% higher productivity with Tim 4G and Dot\*
- DirectRF – digital in/out for high signal purity and improved stability
- Maximizing return due to minimized siting requirements and lower TCO through increased energy efficiency

*\* Case Study Cardiac Dot Engine by: Dr. Russell Bull, Royal Bournemouth Hospital, UK*



# MAGNETIC RESONANCE IMAGING

## 1.5 TESLA

**Toshiba · Vantage Titan**

<b>Gradient</b>	34 mT/m
<b>Slew rate</b>	148 mT/m/ms
<b>Channels</b>	8, 16 or 32 ch

**Highlights**

- Patient friendly 71 cm open bore with 55 x 55 x 50 cm spherical scan area
- Pianissimo, acoustic noise reduction system
- Low couchtop of 43 cm for easy patient access
- Connectivity of 128 coil elements with 8, 16 or 32 channel-readout
- Next generation of contrast-free angiography FBI, CIA, t-slip, TSA, HOP, FSBB
- Image recon of up to 12,600 img/s
- Intuitive M-Power graphical user interface



**Toshiba · Vantage Elan**

<b>Gradient</b>	33 mT/m
<b>Gradient slew rate</b>	125 mT/m/ms
<b>Channels</b>	High Speed Switching

**Highlights**

- Patient friendly 63 cm open bore with 55 x 55 x 50 cm spherical scan area
- Pianissimo Σ, acoustic noise reduction system
- Low couchtop of 45 cm for easy patient access
- Next generation of contrast-free angiography FBI, CIA, t-slip, TSA, HOP, FSBB
- Image reconstruction rate of up to 12,600 img/s
- Intuitive M-Power graphical user interface
- Integrated cooling cabinet



**Wandong · i\_Magnate 1.5T MRI System**

<b>Field strength</b>	1.5T
<b>Gradient</b>	35 mT/m
<b>Slew rate</b>	128 T/m/s
<b>Channels</b>	8

**Highlights**

- Optical RF technology brings higher SNR and better image quality
- Short bore of 140 cm with a spacious bore diameter of 62 cm
- 8 – 32 channel parallel acquisition achieve higher scanning speed
- Zero helium consumption technology
- Mobile device control available
- Powerful workstation with abundant image processing function



**Xingyaoyi (XGY) · SUPERSCAN 1.5 T**

<b>Field</b>	1.5 T
<b>Gradient</b>	30 mT/m
<b>Slew rate</b>	100 mT/m/ms

**Highlights**

- Full range of scanning sequences
- Best performance at low cost
- Matches a wide range of imaging needs in any hospital



## OPEN

**Esaote · G-scan Brio eXP**

<b>Field strength</b>	0.25 T
<b>Gradient</b>	20 mT/m
<b>Slew rate</b>	56 mT/m/ms

**Highlights**

- G-scan Brio eXP is a third generation of dedicated MRI for MSK imaging in supine and weight-bearing position.
- It provides a complete range of MRI imaging sequences, including the most advanced pulse acquisitions, such as Steady State and Fat & Water separation imaging.
- Weight-Bearing MRI gives an added diagnostic value for those pathologies not clearly defined in conventional MRI.

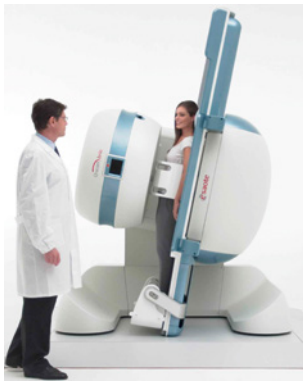

**Esaote · O-scan eXP**

<b>Field strength</b>	0.31 T
<b>Gradient</b>	20 mT/m
<b>Slew rate</b>	100 mT/m/ms

**Highlights**

- O-scan eXP is the third generation of dedicated MRI designed for imaging extremities.
- O-scan provides an outstanding image quality in line with today's standards.
- O-scan with eXP technology makes the exam time of 15 min per patient.
- O-scan break-even figure is only 3 exams/day thanks to an affordable price and very low running costs, compatible with the current healthcare's needs.



### Esate · S-scan eXP

<b>Field strength</b>	0.25 T
<b>Gradient</b>	20 mT/m
<b>Slew rate</b>	56 mT/m/ms

#### Highlights

- S-scan eXP is the third generation of dedicated MRI for imaging of the spine and extremities.
- S-scan with eXP technology features an outstanding image quality both on spine and joints.
- S-scan is perfectly in line with today's need for efficient and economic health care, and is a sensible choice for any imaging center with a substantial musculoskeletal workload.



### Hitachi · APERTO Lucent

<b>Field strength</b>	0.4 T
<b>Gradient</b>	25 mT/m
<b>Slew rate</b>	55 T/m/s



#### Highlights

- Wide, 320 degrees open permanent MRI system
- Features top field strength – 0.4 T – amongst the permanent MRI systems presently on the market
- Newly developed built-in technologies keep APERTO Lucent delivering image quality comparable with entry level HF MRI scanner
- Fast processing chain allows increasing patient throughput
- Reduced running costs allowing fast return of investment

### Hitachi · AIRIS Vento

<b>Field strength</b>	0.3 T
<b>Gradient</b>	22 mT/m
<b>Slew rate</b>	55 T/m/s



#### Highlights

- Comfort class permanent open MRI system, which keeps enhanced capabilities meeting sophisticated open design
- Offers newly developed technologies available at an excellent cost of ownership
- High magnetic field homogeneity
- Environment friendly: extremely low power consumption and reduced installation requirements
- Low running costs allowing fast return of investment

# MR-compatible Monitoring



## MAGLIFE Serenity



MAGLIFE Serenity guarantees highest ECG quality during MRI scanning even under strongest gradient influence.

It is specifically developed to monitor all vital parameters during anaesthesia of adults, children and neonates in an MRI environment.



**SCHILLER**  
The Art of Diagnostics

**Headquarters:**  
SCHILLER AG, Altgasse 68, CH-6341 Baar, Switzerland  
Phone +41 41 766 42 42, Fax +41 41 761 08 80, sales@schiller.ch,  
www.schiller.ch

# MAGNETIC RESONANCE IMAGING

## OPEN

### Hitachi · OASIS

<b>Field strength</b>	1.2 T
<b>Gradient</b>	33 mT/m
<b>Gradient slew rate</b>	100 T/m/s
<b>Channels</b>	8



#### Highlights

- World's most powerful open MRI
- 1.2 T vertical field superconductive magnet for high SNR
- 270° panoramic view, accommodates claustrophobic, paediatric, obese patients
- Fully motorized extra wide 82 cm patient table (up to 300 kg)
- Two-pillar asymmetric design
- Soft Sound Technology
- Multiple coil connectors with Zenith solenoid element based, highly sensitive receiver coils

### Hitachi · AIRIS Vento LT

<b>Field strength</b>	0.3 T
<b>Gradient</b>	22 mT/m
<b>Slew rate</b>	55 T/m/s



#### Highlights

- AIRIS Vento LT (0.3 T) – the economic, compact and wide open MR solution.
- The open system architecture gives not only a feeling of security but also has considerable merits when taking care of small children and elderly patients
  - The floating table allows to fit the system into small spaces while giving the possibility of placing the patient always in the centre to achieve high image quality

### Mindray Medical · MagSense 360

<b>Field strength</b>	0.36 T
<b>Gradient</b>	25 mT/m
<b>Slew Rate</b>	60 mT/m/ms



#### Highlights

- Innovative Inscan Technology
- Advanced Gradient system design
- Ergonomic Design make you more comfortable
- Multi-Clinical Applications satisfied doctors requirement
- Multiple coils selection make all examination reality

### Siemens · MAGNETOM C!

<b>Field strength</b>	0.35 T
<b>Gradient</b>	24 mT/m
<b>Slew rate</b>	55 T/m/ms



#### Highlights

- Smallest pole diameter (137 cm/ 54 inches) for patient comfort
- True, multichannel, seamless imaging (up to 100 cm)
- No cryogen use and low power consumption
- Outstanding image quality at mid-field

### Wandong · i\_Open 0.5T Permanent MRI System

<b>Field strength</b>	0.5T
<b>Channels</b>	4 channels
<b>Gradient</b>	30 mT/m
<b>Slew rate</b>	80 mT/m/ms



#### Highlights

- Two column, large span, super open magnet design
- Six-way movement motorized/manual patient table
- Automatic laser positioning system with two-LCD touch screen control panel
- Four channels digital RF system
- Windows based imaging workstation with user friendly interface provides excellent user experience
- CE & FDA approved

### Wandong · i\_Open 0.36T Permanent MRI System

<b>Field strength</b>	0.36T
<b>Gradient</b>	26 mT/m
<b>Slew rate</b>	65 T/m/s

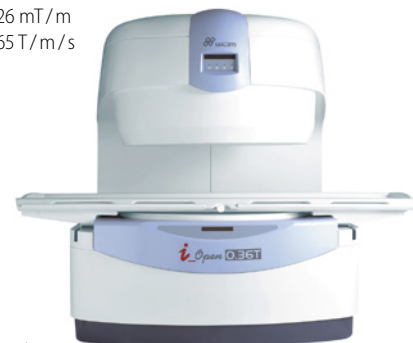

#### Highlights

- C-Shape permanent magnet
- Multi-channel digital RF system
- Cross laser positioning system with two-LCD display panel
- CE and FDA approved
- ACR Accredited
- Windows based imaging workstation with user friendly user interface provides excellent user experience



Xingaoyi (XGY) · OPER 0.5 T

<b>Field</b>	0.5 T
<b>Gradient</b>	24 mT/m
<b>Slew rate</b>	70 mT/m/ms



**Highlights**

- The first mid-field permanent magnet MRI system used in clinical application worldwide
- Full range of scanning sequences, best images
- High throughput, shorter scanning time

Xingaoyi (XGY) · OPER 0.4 T

<b>Field</b>	0.4 T
<b>Gradient</b>	20 mT/m
<b>Slew rate</b>	66 mT/m/ms

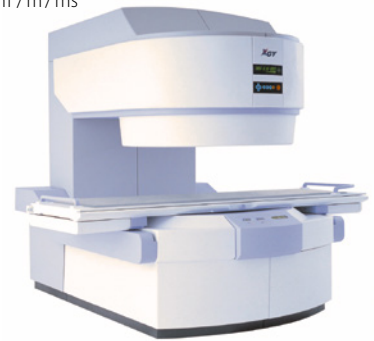

**Highlights**

- Higher SNR and larger imaging range with Multi-RF channels
- Excellent images and full range of scanning sequences
- Low power consumption, low failure rate, high operating ratio
- Requires little space for installation

Xingaoyi (XGY) · OPER 0.35 T

<b>Field</b>	0.35 T
<b>Gradient</b>	19 mT/m
<b>Slew rate</b>	66 mT/m/ms



**Highlights**

- Excellent images, full range of scanning sequences
- Low power consumption, low failure rate
- Small installation site

Xingaoyi (XGY) · OPER 0.3 T

<b>Field strength</b>	0.3 T
<b>Gradient</b>	15 mT/m
<b>Slew rate</b>	48 mT/m/ms



**Highlights**

- Complete function, excellent images, full range of scanning sequences
- Clear quick scan image with high slew rate
- Extremely low power consumption and very low failure rate

MR-PET

Siemens · Biograph mMR

<b>Field strength</b>	3 T
<b>Gradient</b>	45 mT/m
<b>Slew rate</b>	200 T/m/s
<b>Channels</b>	Up to 32

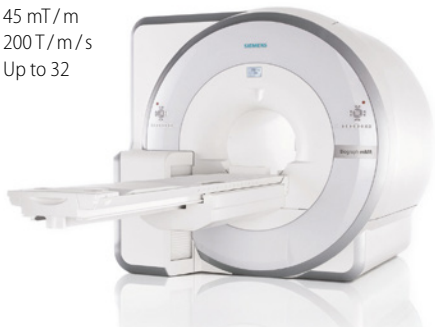

**Highlights**

- Largest customer base with 50 installations worldwide
- Active MR/PET collaboration network of leading institutes
- Simultaneous whole-body acquisition of MR and PET
- Precise alignment of MR and PET in space and time
- MR-based motion compensation of PET images
- State-of-the-art 3 T MRI and cutting-edge molecular imaging fully integrated

SURGICAL MRI

Medtronic · Polestar Surgical MRI System

<b>Magnetic Field</b>	0.15 T
<b>Slew rate</b>	23.5 mT/m
<b>Gradient</b>	80 T/m/s



**Highlights**

- Designed for integration in most ORs using mobile RF shielding
- Compatible with most existing OR-equipment
- Perfect match to neurosurgical workflow
- Fits under OR-table
- Standard patient positioning, no patient movement needed during procedure
- Integrated StealthStation Image Guided Surgery System
- Confirmation of completeness of resection and absence of complications prior to closing

## MRT COILS

### Hologic · Sentinelle Breast MRI Coils

**Channels** 8 and 16 channel



#### Highlights

Hologic's Sentinelle next-generation MRI coils optimize imaging and access, patient care and comfort, and practice efficiency. Sentinelle 8 and 16 channel coils are compatible with Siemens, GE and Toshiba systems.

- Exquisite high resolution images independent of breast size
- Open access for positioning the breast to help ensure appropriate coverage of breast tissue

### NORAS · 4-Channel Flex Coils-Dental Array / Orbit Array

**Field strength** 1 T, 1.5 T and 3 T  
**Channels** 4  
**System platform** Siemens and Philips (1T Philips only)

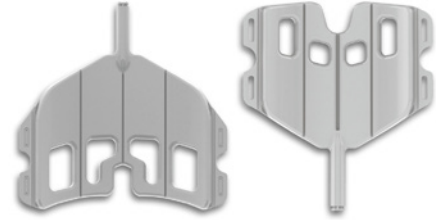

#### Highlights

- The NORAS 4-channel Dental Array has been designed for high-resolution MR imaging of dental structures, periodontal structures and neural structures in the dental area.
- The NORAS 4-channel Orbit Array has been optimized for the MR imaging of the eye socket and orbita. Similar to diving glasses the flex coil is placed directly above the eyes.
- Both deliver a significant higher SNR compared to standard coils.

### NORAS · Biopsy Breast Coil w / Biopsy Unit

**Field strength** 1.5 and 3 T  
**Channels** 4  
**System platform** Siemens, GE (Research mode)

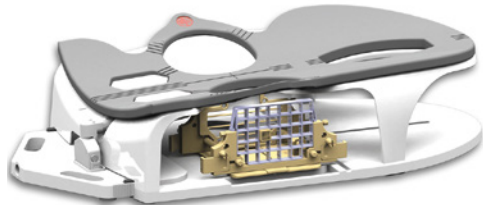

#### Highlights

- The 4-channel Biopsy Breast Coil serves for diagnostics as well as for breast biopsies. A very open designed setup with the NORAS patient rest, guarantees medial, lateral and cranio-caudal access to the breast for interventions.
- The Biopsy Set can be equipped individually with various reusable or disposable intervention components.
- NORAS also offers biopsy sets compatible to GE and Invivo breast coils.

### NORAS · 8-Channel Elbow Array

**Field strength** 1.5 T and 3 T  
**Channels** 8  
**System platform** Siemens

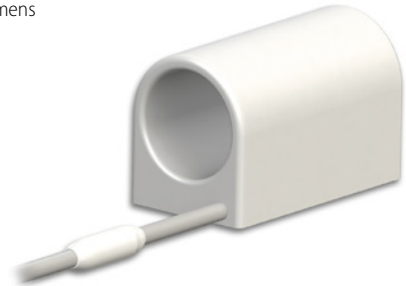

#### Highlights

With the modified loop geometry of the NORAS 8-channel Elbow Array, a significantly improved SNR ratio has been achieved whilst ensuring a homogeneous illumination of the examination area. Due to its very compact and closed design this volume array provides best imaging quality and high contrast in soft tissue visualization helps to show evidence of tumoral, inflammatory and traumatic diseases.

### NORAS · Multipurpose Coils VARIETY and CPC

**Field strength** 1.5 and 3 T  
**Channels** 16 and 8  
**System platform** Siemens (Tim compatible with software update VB19), GE (Research mode)



#### Highlights

- The "Variety" Coil is a 16-channel multipurpose array, which has been developed for high flexibility during examination of challenging anatomic regions. A good example for such areas is the imaging of musculoskeletal areas.
- The specialty of the 8-channel CPC is the high density of small elements for many body regions. Therefore, a high signal gain is given and very high resolutions can be achieved.

### NORAS · Neurosurgery Solution FLEXIBILITY

**Field strength** 1.5 and 3 T  
**Channels** 8  
**System platform** Siemens and Philips

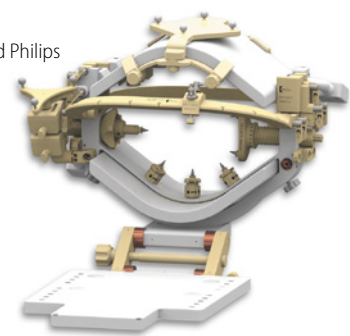

#### Highlights

The new NORAS Head Holder Flexibility consists of a 8-channel iMRI Head Coil for imaging and intervention in a neurosurgical OR environment. Being height adjustable the setup enables optimal positioning in 70 cm bore systems. Moreover, the Head Holder is movable along the bore direction, which facilitates flexible patient positioning on the transfer board. Head fixations with 3 up to 5 pins are supported.

ACCESSORIES / COMPLEMENTARY SYSTEMS

Alliance Medical · Flexible diagnostic imaging services



**Highlights**

- Static diagnostic imaging centers MRI, CT, PET, PET / CT
- Interim services for bridging downtimes
- Regular "routing" services

Alliance Medical · Modular building solutions



**Highlights**

- Engineering, rental, sale of modular buildings MRI, CT, PET, PET / CT including or excluding diagnostic equipment

GCTechnology · CIRS Phantoms

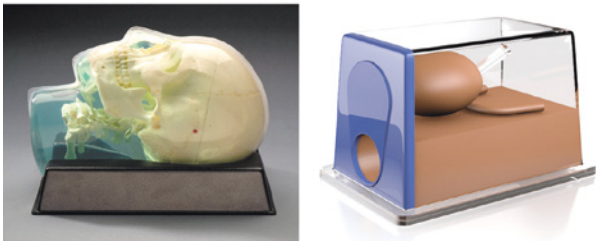

**Highlights**

- Anthropomorphic 3D skull phantom (multi modality = CT, US, MR)
- Prostate training phantoms family (multi modality)
- Pelvic phantom (multi modality)
- 3D abdominal phantom (multi modality)
- Lumbar training phantom (multi modality)
- Biopsy training breast phantom (multi modality)
- Gillian QA phantom (multi modality)

mediCAD – hectec · mediCAD hybrid 3D



**Highlights**

- This new module opens up a whole new world for planning doctors. Now you can use CT or MRT images to plan in three dimensions. With fully automated recognition of all present vertebrae and segments, mediCAD 3D provides you with active support while performing a wide variety of measurements. Also available our 3D hip and trauma planning solution in 2015.

SCHILLER · MAGLIFE light



**Highlights**

- MRI compatible up to 3 Tesla
- Parameter: SPO2 and/or NIBP
- Mains and battery driven (1.5 hours)
- Optimized for day to day application
- No installation necessary
- HTML printing function
- Optimized for adult children and neonates

SCHILLER · MAGLIFE Serenity



**Highlights**

- Highest ECG quality even under strongest gradient influence
- MRI compatible up to 3 Tesla
- Optical core and skin temperature
- Configuration for anaesthesia, cardiac and intensive care applications
- Patented artefact inhibition
- Optimized for adult children and neonates
- Wireless Data Transmission
- Wireless or optically wired SpO2
- Mains and battery driven
- 12.1" color display



# Injectors



**APOLLO RT · APO200 – CT Dual syringe Injector**

**Syringe** 100 ml syringe / 200 ml syringe  
**Pressure** 350 PSI  
**Flow rate** 0.1-10.0 ml/s (0.1 / s increment)  
**Application** CT



**Highlights**

- Large LCD Colour Touchscreen
- Intuitive User Friendly Interface
- Unique Variable Flow Rate setting
- Set Injection Protocols using Patient Bodyweight and ROI
- Real-time Pressure Graph during injection period
- Software easily upgraded using SD Card

**APOLLO RT · APO100 – CT Single syringe Injector**

**Syringe** 100 ml syringe / 200 ml syringe  
**Pressure** 350 PSI  
**Flow rate** 0.1 – 10.0 ml/s (0.1 / s increment)  
**Application** CT



**Highlights**

- Large LCD Colour Touchscreen
- Intuitive User Friendly Interface
- Unique Variable Flow Rate Setting
- Multi Injection Modes
- Real-time Pressure Graph during injection period
- Software easily upgraded using SD Card

**APOLLO RT · APO100M – Angio Mammo Dedicated Injector**

**Syringe** 100 ml syringe / 200 ml syringe  
**Pressure** 300 PSI  
**Flow rate** 0.1 – 5.0 ml/s (0.1 / s increment)  
**Application** Digital Mamography (CESM)



**Highlights**

- Compact all in one configuration
- Simple and easy to operate
- Designed for Digital Mammography

**APOLLO RT · RT150 – Angio + Cath. Lab. Injector**

**Syringe** 150 ml syringe  
**Pressure** 1200 PSI  
**Flow rate** 0.1 – 40.0 ml/s (0.1 / s increment)  
**Application** Angiography



**Highlights**

- Advanced Features to allow maximum utility
- Multi Injection modes for Large and Small Vessel Injections
- Unique Hand Controlled Variable Flow Rate
- Real-time Pressure Graph during injection period
- Innovative Mechanical Stop

**Bayer · MEDRAD Avanta Advanced Fluid Management System**

**Pressure** 300 / 1,200 psi / bar  
**Capacity** 150 ml Selectable pressure increment  
**Flow rate** Variable 1 to 10 ml/sec



**Highlights**

- Contrast and saline flush cardiovascular power injector
- Precise fluid delivery, fluid level sensing and gross air detection
- Accurate injection pressure control with user adjustable pressure limits
- Bolus sharpness delivering exact variable and fixed contrast via a responsive syringe
- Color graphical user interface with on screen tutorial for simplified setup

**Bayer · MEDRAD Intego PET Infusion System**

**Flow rate** 18F-FDG or 18F-Na  
 0.5 ml/sec, 1 ml/sec



**Highlights**

- PET Infusion System for the dose administration of 18F-FDG or 18F-Na
- Automated dose preparation and patient infusion in a single mobile system:
  - Reduce radiation exposure to clinicians
  - Dose preparation, patient infusion, and saline flush all combined into one system enables accurate Delivered vs. Prescribed Dose (± 2%)

## INJECTORS

### Bayer · MEDRAD Dual Syringe CT Injector Stellart D

<b>Syringe</b>	A and B: 200 ml
<b>Pressure</b>	325 psi (22.1 bar)
<b>Flow rate</b>	A and B: 0.1 – 10 ml/sec in 0.1 ml/sec increments



#### Highlights

- Saline Flush Capability for contrast efficiency
- Automated loading, filling, and priming
- Stores and recalls up to 32 programs
- Precisely times contrast delivery with real-time display of injection pressure

### Bayer · MEDRAD Mark 7 Arterion

<b>Syringe</b>	150 ml
<b>Pressure</b>	100 – 1,200 psi
<b>Flow rate</b>	0.1 – 45.0 ml/sec; 0.1 – 59.9 ml/min; 0.1 increments

#### Highlights

- The Mark 7 Arterion Injection System is MEDRAD's latest angiographic injector
- The Mark 7 Arterion is lighter, more maneuverable and easier to use so you can focus more on the patient
- It has a clear and intuitive user interface and a unique front-load system to simplify set-up and tear-down
- The clear syringe facilitates purging air
- Multiple configurations for maximum flexibility



### Bayer · MEDRAD MRXperion

<b>Syringe</b>	Contrast media 65 ml – Saline 115 ml
<b>Pressure</b>	Maximum 325 psi / 2,240 kpa
<b>Flow rate</b>	Selectable from 0,01 ml/sec to 10 ml/sec

#### Highlights

- Streamlined Injection Workflow allows more focus on the patient
- Enhanced Point of Care by bringing more injector functionality into the scan room
- Informatics-ready – Radimetrics Enterprise Platform connectivity facilitates standardized injection protocols and operational consistency
- Maximized Uptime Support – VirtualCare Remote Service enhances injector up-time



### Bayer · MEDRAD Spectris Solaris EP

<b>Syringe</b>	Contrast media 65 ml – Saline 115 ml
<b>Pressure</b>	Maximum 325 psi / 2,240 kpa
<b>Flow rate</b>	Selectable from 0,01 ml/sec to 10 ml/sec

#### Highlights

- Flexible power management with battery operation or continuous battery charging through AC power connection
- Pressure Limit selection from one of six preset maximum pressure limits, and the ability to view pressure during injection on the control room display
- 3T compatibility
- Multiphase injection control with 6 user-programmable phases including PAUSE and HOLD
- Programmable KVO



**Buy & sell used equipment on**



[www.dotmed.com](http://www.dotmed.com)

**Over 400,000 listings**  
**Over 20,000 daily visitors**

### Bracco · CT Express

<b>Syringe</b>	Syringeless injector
<b>Pressure</b>	9.1 bar max
<b>Flow rate</b>	0.5 – 9.9 mL/s in steps of 0.1 mL/s
<b>Application</b>	CT

#### Highlights

- Direct injection from contrast media bottles
- Air and occlusion detection on fluid channels
- Unidirectional flow of fluid
- Locking and automatic filling
- Digital interface, dual touch screens
- DiluJect (optional): contrast media and saline are injected in rapidly alternating flow through the injector





**Bracco · EmpowerCTA+**

**Syringe** 200 ml (CM), 200 ml (NaCl)  
**Pressure** 40 to 325 psi in user-specified increments of 1 psi  
**Flow rate** 0.1 to 10.0 ml/sec in user-specified increments of 0.1 ml/sec  
**Application** CT

**Highlights**

- Tilt sensor / lockout
- Arming at the injector
- Independently rotating and very compact injector head (270 degrees)
- Integrated electroluminescent display
- Modular flexibility of components and WINDOWS based software allow optimal serviceability and enhanced expandability
- Touch-screen color LCD display and intuitive software



**Bracco · EmpowerMR**

**Syringe** 100 ml (CM), 100 ml (NaCl)  
**Pressure** 40 to 300 psi in user-specified increments of 1 psi  
**Flow rate** 0.1 to 10.0 ml/sec in user-specified increments of 0.1 ml/sec  
**Application** MR

**Highlights**

- Hydraulic injector system
- MRI compatible through the use of polymers and non-ferromagnetic metals
- Little contrast media waste due to the very short distance between injector head and patient
- Very lightweight injector head
- No active components in the shielded room (no battery)



# The new Accutron® MR3

Tried-and-tested innovative Accutron® technology **Made in Germany!**

Only **one remote control** required!

Administration of fluids even **during the MR-examination!**



**New!**  
with integrated infusion pump!

Contrast medium injectors and consumables for CT, MRI and angiography

Hauptstrasse 255 · D-66128 Saarbruecken

For more info: [www.medtron.com](http://www.medtron.com)



# INJECTORS

## Medicor · Nemoto CT-Injector Dual Shot Alpha 7

**Syringe** Contrastmedia A: 200 ml, 100 ml with adapter / 125 ml with prefilled syringe adapter; Saline B: 200 ml, 100 ml with adapter

**Throughput** A: 1 – 100/125/200 ml in 1 ml-steps; B: 1 – 100/200 ml in 1 ml-steps

**Max. injection pressure** A: 300 psi, B: 300 psi

### Highlights

- Needle positioning test
- Programmable autofill function
- Program memory on CF memory card
- Timing bolus option
- Auto prime function
- 5 x 20 protocol memories
- Automatic body weight protocol function
- Advanced programming functions



## Medicor · Nemoto CT-Injector Dual Shot Alpha 7S

**Syringe** A: Contrastmedia A: 200 ml, 100 ml with adapter; B: Saline: Saline 200 ml, 100 ml with adapter

**Flow rate** 0,1 – 10 ml/sec

**Throughput** A: 1 – 100 ml/200 ml in 1 ml-steps; B: 1 – 100 ml/200 ml in 1 ml-steps

**Pressure** A: 300 psi; B: 300 psi

### Highlights

- Needle positioning test
- Timing bolus injection
- Simple user interface
- New design with only two components
- Multi-Language available
- Three protocols memory / anatomical area
- Software upgrade via SD-card



## Medicor · Nemoto CT-Injector SmartShot alpha

**Syringe** 100/200 ml with adapter

**Flow rate** 0.1~10 ml/s in 0.1-ml/s

**Max. injection pressure** 300 psi

### Highlights

- Friendly Design
- Touchscreen / Color LCD



- Simple Operation and Interface
- Real Time Pressure
- Protocol Memory

## Medicor · Nemoto Rem Press

**Capacity** 1 – 150 ml

**Flow rate** 0,1 – 25 ml/sec

**Max. injection pressure** 50 – 1200 psi

### Highlights

- Easy to see setup screen ensures injection setting
- Remaining volume in the syringe can be checked from the side of the powerhead display
- Syringe light illuminates the syringe tip and the gasket area, which helps to check for remaining air bubbles
- During injection the syringe light indicates the injection status by flashing
- Optional foot switch



## Medicor · Nemoto Sonic Shot GX

**Syringe** 60 ml; prefilled syringe with adapter

**Flow rate** 00,1 – 10 ml/sec

**Max. injection pressure** 200 psi

### Highlights

- Intuitive touchscreen interface
- Easy to view color display
- Convenience of using pre filled syringes
- No magnetic or RF interferences
- Ceiling mounting option



## MEDTRON · Accutron CT

**Flow rate** 0.1 – 10 ml/s, programmable in steps of 0.1 ml/s

**Capacity** 200 ml Easy Loading Syringe (ELS)

**Max. injection pressure** 21 bar (304 psi)

**Filling of syringe** Automatic or manual filling, filling speed 1–5ml/s, optimized tube systems with check valve

### Highlights

- Wireless injector unit, rechargeable batteries
- Integrated heated syringe holder with Easy Loading Syringe (ELS) 200 ml
- Touchscreen control panel with different languages
- Wireless touchscreen remote control
- Secured injection position (built-in sensor)
- Aluminium housing
- Use of prefilled syringes (as an option)



## MEDTRON · Accutron CT-D

<b>Flow rate</b>	For both injection units: 0.1 – 10 ml/s, programmable in steps of 0.1 ml/s
<b>Capacity</b>	200 ml (CM), 200 ml (NaCl) Easy Loading Syringe (ELS)
<b>Max. injection pressure</b>	21 bar (304 psi)
<b>Filling of syringe</b>	Automatic or manual filling, filling speed 1 - 5 ml/s optimized tube systems with check valve

### Highlights

- Wireless injector unit with rechargeable batteries
- Integrated heated syringe holder for Easy Loading Syringe (ELS)
- Wireless touchscreen remote control
- Use of prefilled syringes (as an option)
- Secured injection position (built-in sensor)
- Alternatively, display of injection parameters or pressure graph
- Aluminium housing – wall or ceiling suspension
- CANopen Interface (as an option)



## MEDTRON · Accutron HP

<b>Flow rate</b>	Angio mode: 0.1 – 30 ml/s, CT mode: 0.1 – 10 ml/s programmable in 0,1 ml/s increments
<b>Capacity</b>	200 ml
<b>Max. injection pressure</b>	Angio mode: 83 bar (1,200 psi), CT mode: 21 bar (305 psi), programmable in 1 bar increments
<b>Filling of syringes</b>	Automatic or manual filling, filling speed 1-4 ml/s opt. high-pressure tube systems with check valves

### Highlights

- Fast high-pressure injections for angiography and multiphase injection profiles for computed tomography
- Wireless injector unit with rechargeable batteries
- Wireless touchscreen remote control (as an option)
- Wall or ceiling suspension system
- Integrated heated syringe holder for Easy Loading Syringe (ELS) 200 ml
- 120 injection profiles can be defined and stored by the user (60 angio / 60 CT)
- Aluminium housing – Interface (as an option)



## MEDTRON · Accutron HP-D

<b>Flow rate</b>	Angio mode: 0.1 – 30 ml/s, CT-mode: 0,1 – 10 ml/s programmable in 0,1 ml/s increments
<b>Capacity</b>	200 ml (CM), 200 ml (NaCl) Easy Loading Syringe (ELS)
<b>Max. injection pressure</b>	Angio mode: 83 bar (1,200 psi), CT mode: 21 bar (305 psi), programmable in 1 bar increments
<b>Filling of syringes</b>	Automatic or manual filling, filling speed 1-4 ml/s opt. high-pressure tube systems with check valves

### Highlights

- Wireless injector unit with rechargeable batteries
- Multiphase program controlled injection of CM & NaCl
- Single or multi injection mode
- Integrated heated syringe holder for Easy Loading Syringe (ELS)
- Touchscreen control panel with different languages
- Up to 3 phases – pressure graph – secured injection position (built-in sensor)
- 60 injection profiles can be defined and stored by the user
- Interface (as an option) – Aluminium housing



## MEDTRON · Accutron MR

<b>Flow rate</b>	0.1 – 10 ml/s programmable in 0.1 ml/s increments
<b>Capacity</b>	64 ml or 200 ml (CM), 65 ml or 200 ml (NaCl) Easy Loading Syringe (ELS)
<b>Max. injection pressure</b>	21 bar (304 psi)
<b>Filling of syringes</b>	Automatic or manual filling, filling speed 1–5 ml/s optimized tube systems with check valve

### Highlights

- Wireless injector unit with rechargeable batteries
- Touchscreen control panel with different languages
- Wireless touchscreen remote control
- Up to 6 phases – secured injection position
- Use of prefilled syringes (as an option)
- Alternatively, input of flow rate or phase duration
- Pressure graph
- Aluminium housing



## MEDTRON · Accutron MR3

<b>Flow rate</b>	CM/NaCl: 0,1 – 10 ml/s, programmable in 0,1 ml/s increments, Infusion pump: 0,001 – 30 ml/min
<b>Capacity</b>	CM: 64 ml (ELS), NaCl: 200 ml (ELS) Infusion pump: 50 ml
<b>Max. injection pressure</b>	21 bar
<b>Filling of syringes</b>	Automatic or manual filling, filling speed 1 – 4 ml/s optimized tube systems with check valve

### Highlights

- Contrast medium injector with integrated infusion pump
- Wireless injector unit with rechargeable batteries
- Touchscreen control panel with different languages
- Wireless touchscreen remote control
- Up to 6 phases
- Alternatively, input of flow rate or phase duration
- Aluminium housing



## ulrich · INJECT CT motion (XD 8000)

<b>Application</b>	CT
<b>Capacity</b>	All commercially available media containers (CM 2x500 ml, NaCl 1x1,000 ml)
<b>Max. injection pressure</b>	17 bar (246.6 psi)

### Highlights

- Unique roll pump system for more cost-effectiveness
- Two-piece tubing system with check valves and particle filter
- 24 hours on-label-use of the pump tubing for highest hygiene
- Direct and multiple injections from all commercially available media containers
- 5 detectors to reliably prevent air injection and selectable range of pressure limits
- Efficient workflow and fast patient changeover





# INJECTORS

## ulrich · missouri (XD 2001)

**Application** CT  
**Capacity** All commercially available media containers (CM max. 2 x 1,000 ml, NaCl max. 1 x 2,000 ml)  
**Max. injection pressure** 16 bar (232 psi)

### Highlights

- Unique roll pump system for more cost-effectiveness
- Two-part hose system with check valves and particle filter
- Sensors to prevent air injection and integrated pressure control system
- Large media supply for multiple injections consecutively from one media container
- Three media accesses for use of all commercially available media containers
- Efficient workflow and fast patient changeover



## ulrich · mississippi (XD 2000)

**Application** MRI (up to 3 T)  
**Capacity** All commercially available media containers [CM max. 2 x 1,000 ml (for CT), CM max. 1 x 100 ml (for MRI), NaCl max. 1 x 2,000 ml]  
**Max. injection pressure** 16 bar (232 psi)

### Highlights

- Unique roll pump system for more cost-effectiveness
- Two-part hose system with check valves and particle filter
- Three media accesses for use of all commercially available media containers
- Large media supply for multiple injections consecutively from one media container
- Integrated pressure control system
- Sensors to prevent air injection
- Efficient workflow and fast patient changeover



## ulrich · ohio M (XD 2004)

**Application** MRI (up to 3 T)  
**Capacity** All commercially available media containers [CM max. 2 x 1,000 ml (for CT), CM max. 2 x 100 ml (for MRI), NaCl max. 1 x 2,000 ml]  
**Max. injection pressure** 16 bar (232 psi)

### Highlights

- Unique roll pump system for more cost-effectiveness
- Two-part hose system with check valves and particle filter
- Direct and multiple injections from all commercially available media containers
- Choice between two different contrast agents without change of media containers
- Integrated pressure control system
- Sensors to prevent air injection
- Efficient workflow and fast patient changeover



## ulrich · ohio tandem (XD 2002)

**Application** CT  
**Capacity** All commercially available media containers (CM max. 2 x 1,000 ml, NaCl max. 1 x 2,000 ml)  
**Max. injection pressure** 16 bar (232 psi)

### Highlights

- Unique roll pump system for more cost-effectiveness
- Two-part hose system with check valves and particle filter
- Direct and multiple injections from all commercially available media containers
- Choice between two different contrast agents without change of media containers
- Integrated pressure control system
- Sensors to prevent air injection
- Efficient workflow and fast patient changeover



## ulrich · powerINJECT Adam (XD11000)

**Application** Angiography  
**Flow rate** 0.1 – 40 ml/s  
**Max. injection pressure** 82.7 bar (1200 psi)

### Highlights

- Simple and safe handling
- Economical and efficient
- Optimal workflow and time-saving examinations
- Syringe set with spike for highest hygiene



## ulrich · tennessee (XD 2003)

**Application** MRI (up to 3 T)  
**Capacity** All commercially available media containers [CM max. 2 x 1,000 ml (for CT), CM max. 2 x 100 ml (for MRI), NaCl max. 1 x 2,000 ml]  
**Max. injection pressure** 16 bar (232 psi)

### Highlights

- Unique roll pump system for more cost-effectiveness
- Two-part hose system with check valves and particle filter
- Three media accesses for use of all commercially available media containers
- Large media supply for multiple injections consecutively from one media container
- Integrated pressure control system
- Sensors to prevent air injection
- Efficient workflow and fast patient changeover



# Interventional Systems



Hybrid  
Bi-Plane  
Single Plane  
Surgical II-C-Arms  
Surgical Flat Panel C-Arms  
Accessories /  
Complementary Systems



GCTechnology GmbH



HOLOGIC®



Medtronic



SIEMENS

TOSHIBA



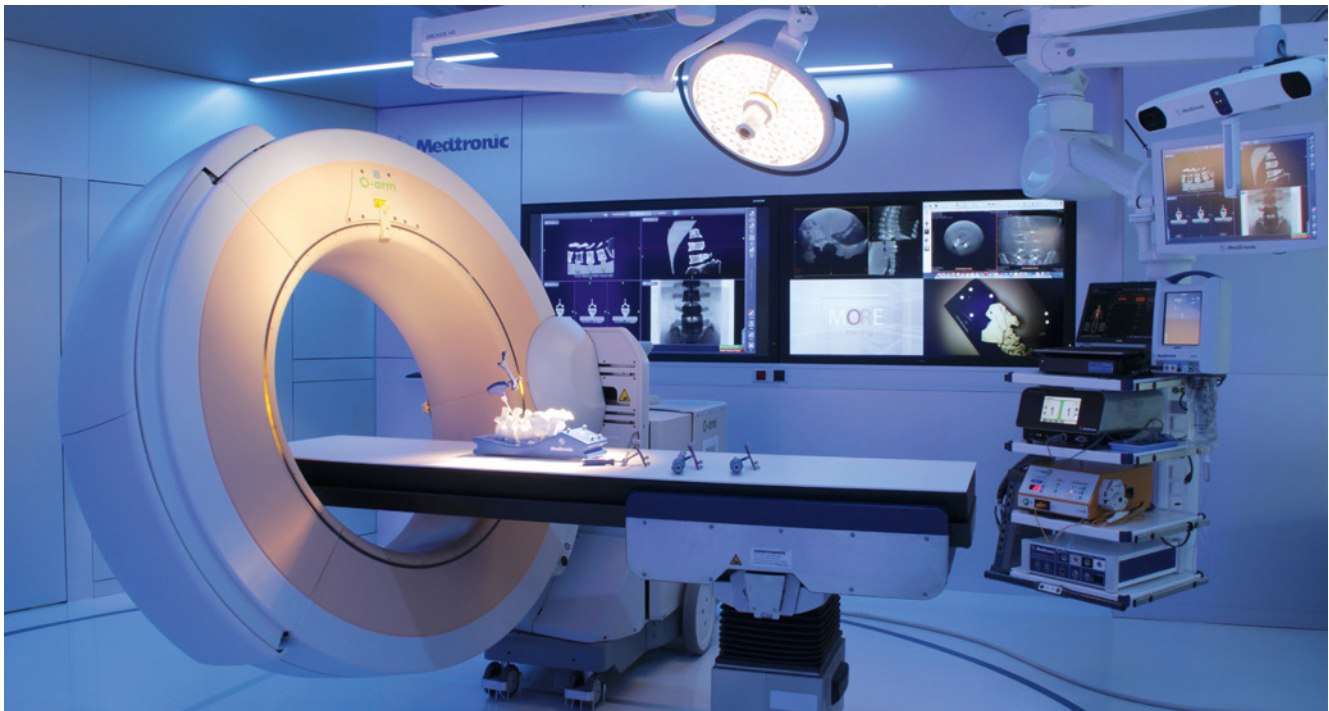

The World leader in intraoperative 2D/3D Spine Imaging

# O-arm – Mobile Surgical Imaging System

## The O-arm – designed for surgery

The O-arm has successfully established as a gold standard imaging device for high contrast items in the market. Surgeons, all over the world consider the O-arm their system of choice, convinced by image quality, ease of handling, and reliability. Continuous development and innovation will allow the user to expand their clinical indications for use and applications in the future. In the modern OR, intraoperative imaging is an integral tool for the surgical team striving for the best patient outcomes. The O-arm System has brought intraoperative imaging to a new level, with superior image quality and large field-of-view in both 2D & 3D image sets, providing surgeons with the information they need most, precisely when they need it. This allows the surgeon to plan, implement and confirm success of the surgical procedure before the patient leaves the OR.

The completely motorized system supports quick and easy handling and a smooth workflow, allowing the surgeon to work in a better-controlled environment and therefore to focus entirely on the patient. Image quality, patient safety, sterility and ease of use in the OR are essential design criteria for the O-arm system. The system optimally supports the surgical workflow and creates a controlled surgical environment by minimizing manipulations needed during the procedure. With the unique and patented breakable gantry the O-arm provides vital lateral patient access, which is essential for optimal patient positioning and surgical workflow. Compatibility

with standard radiolucent operating tables allows an easy adaptation to any standard OR.

Through robotic positioning the O-arm System remembers your best views. Programmable memory stores the exact position of the gantry and detector as well as any X-ray technique, in up to four imaging positions. The user can recall the exact image position at the touch of a button any time during surgery, eliminating time-consuming repositioning and additional X-ray exposure for scouting.

When not needed for imaging, the gantry moves to the user-defined park position within seconds, allowing surgeon's patient access while maintaining the integrity of the sterile field as the O-arm can remain in the surgical field. As the O-arm is fully mobile, it can be removed from the OR at any time of the surgery and be used in a parallel intervention.

## Navigate more efficient than ever before

The O-arm System seamlessly integrates with Stealth Station navigation to reduce X-ray exposure – increasing safety for both OR staff and patients. Surgical Navigation provides the surgeon with information about the patient's anatomy while reducing the X-ray exposure to patient, surgeon and staff.

For a listing of indications, contraindications, precautions, warnings, and potential adverse events, please refer to the Instructions of Use.



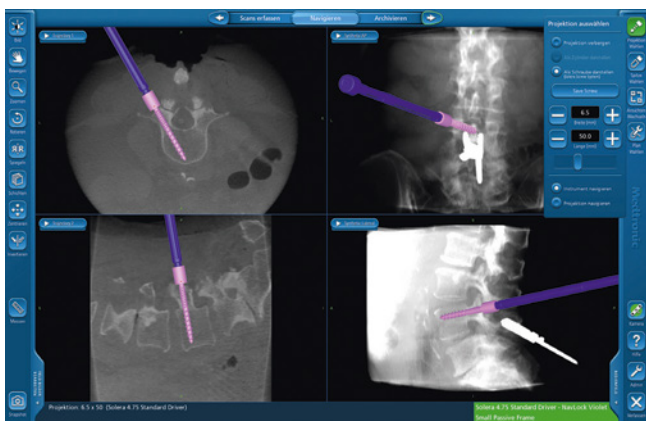

Automatic Data Transfer of the patient’s 3D data set, as well as of the AP and lateral images, and automatic anatomical registration on the Stealth Station Navigation System eliminating the need for lengthy patient registration, allowing the surgeon to navigate within seconds after image acquisition, thereby increasing procedural efficiency.

Additional 3D Datasets may be acquired whenever needed during surgery, making navigation easy to use, more effective and more reliable than ever before. The Synergy Experience Advanced Navigation User Interface is streamlined to fit the workflow in the OR and to support the surgeon’s work.

**Because trust matters – trust through quality and reliability**

Since its market launch in 2006, the O-arm has revolutionized intra-operative imaging. Within the last eight years, the O-arm has become the gold standard in the area of intra-operative 2D/3D spine imaging. Users from all world trust the high product quality, unequalled reliability and versatility of the O-arm.

Through continuous advancement of the hardware and software, the reliability is at the level of a fix installed diagnostic CT. As a reliable service partner, Medtronic ensures the best possible performance and availability of the O-arm throughout its entire service life.

The experience gained over the years is passed on to new users by supervisors in training centers and by on-site Medtronic staff. The annual users’ meetings and international special events offer the perfect platforms for sharing and exchanging experiences. The Medtronic experts are also happy to assist you as needed—during clinical application in the operating theatre.



**The O-arm in numbers:**

- 700+ O-arm global installations
- 150+ O-arm installations in Europe
- 250,000+ Patients benefited from O-arm use
- 1,500+ Surgeon user worldwide

**Because trust matters – trust through continuous advancement**

The O-arm was developed specifically for use in the operating theatre. Every day, physicians in neurosurgery, orthopedics, trauma surgery, and also in ENT, benefit from the advantages of the system during countless interventions. Over 140 peer-reviewed articles document the benefits of the system, both during bone surgery as well as during cranial interventions. Thanks to the continuous technical advancement of the O-arm, today physicians and patients benefit from Improved 2D & 3D image quality, Expanded range of application and Lower dose rate.

**Transforming surgical practice**

Medtronic is not only commitment is not limited to hospital equipment. Our SurgicalSynergy program is offering hospitals complete solutions for the entire surgery from preoperative planning to the patient closure. We can leverage synergies that will help transform the surgical experience, drive better patient outcomes, and enhance economic value. Surgical Synergy is a synthesis of surgical, procedural, and therapeutic innovations from our Spine, Neuro-modulation, and Surgical Technologies businesses.

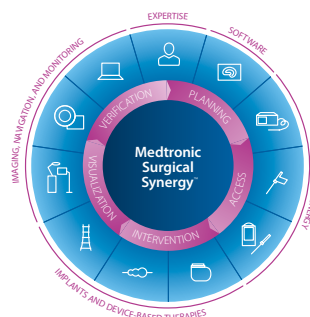

With the depth and breadth of our expertise and technologies, we offer integrated procedural solutions that can help support your goals of:

- Advancing patient care.
- Performing faster, more precise procedures.
- Reducing patient complications and improving clinical outcomes.
- Achieving better economic value.
- Enabling more minimally invasive and complex procedures.

With Medtronic Surgical Synergy we offer you a unique integration of innovative surgical technologies with treatments, implants and therapeutic devices to drive procedural excellence and optimal patient care. Only Medtronic offers the depth and breadth of experience and technologies that can respond to your needs, no matter the case.

# INTERVENTIONAL SYSTEMS

## HYBRID

### Toshiba · Infinix 4DCT

**Design** Integration of High End CT with dedicated C-Arm System



#### Highlights

- This integrated system combines premium CT and ceiling-mounted angiography technology
- The perfect diagnostic and treatment set-up for high-risk procedures in various interventional segments
- Interventional Oncology
- Trauma
- Neuro / Stroke
- General Vascular
- Additional or Backup CT Available with three different CT configurations: Aquilion ONE VE / Aquilion PRIME / Aquilion LB

## BI-PLANE

### GE Healthcare · Innova IGS 630

**DQE** 77 %  
**Detector** Biplane Angio system  
**Size** 30x30 cm frontal / 30x30 cm lateral



#### Highlights

- Optimal detector size for dedicated neuro applications
- High detector DQE and AutoEx for dose optimization
- Innova CT HD, enhanced 3D imaging
- Advanced 3D guiding technology
- Integrated large display monitor

### GE Healthcare · Innova IGS 620

**DQE** 79 %  
**Detector** Biplane Cardiac system  
**Size** 20x20 cm frontal / 20x20 cm lateral



#### Highlights

- Smart gantry for optimal C-arm positioning
- High detector DQE and AutoEx for dose optimization
- Complete integration of intra-vascular-ultrasound, FFR
- InnovaSense patient contouring
- Integrated large display monitor

### Shimadzu · Trinias B12 / B8

**Size** 12" x 12" (30x30 cm) / 8" x 8" (20x20 cm)  
**Detector** Dynamic flat panel detector (CsI)  
**Resolution** 2.58 Lp / mm



#### Highlights

- Wide coverage for smooth operability
- SCORE PRO Advance image processing technology
- Unique pioneering imaging technology: motion-tolerant SCORE RSM
- SCORE StentView
- SCORE CT
- SCORE 3D
- SCORE Navigation
- SMART design concept
- Comprehensive dose management package

### Siemens · Artis biplane

**Power** 100 kW  
**Detector** a-Si / CsI, 20x20 (1,024x1,024 pixels), 184 µm  
 a-Si / CsI, 30x40 (1,920x2,480 pixels), 154 µm  
 zen30HDR, hi-res crystalline silicon / CsI, (1,792x1,632 pixels), 160 µm

#### Highlights

Biplane system for interventional imaging. The Artis biplane system offers high performance in interventional imaging combined with high positioning flexibility.

- Left-side biplane imaging position for free head access
- Single plane operation with extended position flexibility enabled by rotated table
- Ergonomic system controls for smooth table-side operation
- 3D acquisition rate up to 75 f/s



### Toshiba · Infinix CF-i / BP

**Power** 100 kW  
**Detector** 20x20 cm flat panel detector

#### Highlights

Cardio intervention demands speed, precision, and optimum performance. The Infinix CF-i / BP is designed to take advantage of the latest technological innovations to reduce dose and to save time. A revolutionary graphic user interface and a multi-tasking computer enable the system to fully meet the requirement for optimum image quality, safety, ease of use, advanced efficiency and improved workflow.



**Toshiba · Infinix DP-i**

**Power** 100 kW  
**Detector** 20x20 cm and 30x40 cm flat panel detector  
**Pixel size** 194 µm



**Highlights**

- A single room X-ray solution with dedicated imaging chains for interventional cardiac and angiography procedures that share a common generator, table, monitors and digital acquisition system. Designed for both diagnostic and interventional examinations.
- Space, time and dose saving technology are key design elements of the Infinix DP-i.

**Toshiba · Infinix VF-i/BP**

**Power** 100 kW  
**Detector** 30x30 cm and 30x40 cm or 30x30 cm and 30x30 cm flat panel detector  
**Pixel size** 194 µm



**Highlights**

- Vascular intervention demands speed, precision, and optimum performance. The Infinix VF-i/BP is designed to take advantage of the latest technological innovations to reduce dose and to save time. A revolutionary graphic user interface and a multi-tasking computer enable the system to fully meet the requirement for optimum image quality, safety, ease of use, efficiency and improved workflow.

**SINGLE PLANE**

**GE Healthcare · Discovery IGS 740**

**DQE** 77 %  
**Detector** a-Si  
**Size** 41x41 cm



**Highlights**

- Laser-guided system
- Multiple parking and back-out positions
- Large field of view for big anatomies coverage
- Latest 3D Advanced Applications
- Wide Bore 3D for easier 3D acquisition
- Arm trajectories for Interventional Radiologist
- High detector DQE
- AutoEx: Dynamic exposure optimization
- Integrated large display monitor
- Functionalities integration at tableside

**GE Healthcare · Discovery IGS 730**

**DQE** 77 %  
**Detector** a-Si  
**Size** 30x30 cm



**Highlights**

- Laser-guided system
- Multiple parking and back-out positions
- Optimal detector size for hybrid procedures
- Latest 3D Advanced applications
- Wide Bore 3D for easier 3D acquisition
- High detector DQE
- AutoEx: Dynamic exposure optimization
- Integrated large display monitor
- Functionalities integration at tableside

**GE Healthcare · Innova IGS 540**

**DQE** 77 %  
**Detector** 2 k a-Si  
**Size** 41x41 cm



**Highlights**

- Large imaging Field of View
- High detector DQE and AutoEx for dose optimization
- Latest 3D-guiding solutions
- Integrated large display monitor
- Functionalities integration at tableside

**GE Healthcare · Innova IGS 530**

**DQE** 77 %  
**Detector** 1.5 k a-Si  
**Size** 30x30 cm



**Highlights**

- Optimal detector size for combo procedures
- Fast gantry with patient contouring system
- High detector DQE and AutoEx for dose optimization
- Integrated large display monitor
- Functionalities integration at tableside

## INTERVENTIONAL SYSTEMS

### SINGLE PLANE

#### GE Healthcare · Innova IGS 520

<b>DQE</b>	79 %
<b>Detector</b>	1 k a-Si
<b>Size</b>	20x20 cm



#### Highlights

- Optimal detector size for cardiac interventions
- Fast gantry with patient contouring system
- High detector DQE and AutoEx for dose optimization
- Integrated large display monitor
- Easy accessibility to functions at table side
- A set of advanced clinical tools to help Plan, Guide, Assess complex procedures

#### GE Healthcare · Optima CL 323i

<b>DQE</b>	77 %
<b>Detector</b>	1.5 k a-Si
<b>Field of View</b>	31x31 cm



#### Highlights

- Optimal detector size for general combo procedures
- A set of clinical tools including 3D imaging capabilities to meet the needs of a wide range of interventional cardiology + interventional radiology procedures

#### GE Healthcare · Optima IGS 320

<b>DQE</b>	79 %
<b>Detector</b>	1 k a-Si
<b>Field of View</b>	20x20 cm



#### Highlights

- Optimal detector size for general cardiology and electrophysiology procedures
- Set of visualization and quantitative analysis tools dedicated to cardiologists needs
- Low frame rate to minimize dose even further for electrophysiology procedures

# Buy & sell used equipment on



[www.dotmed.com](http://www.dotmed.com)

**Over 400,000 listings**  
**Over 20,000 daily visitors**

#### INTERMEDICAL · RADIUS XP 100 CARDIO – CEILING SUSPENDED

<b>Power</b>	100 kW
<b>Detector</b>	Digital Flat Panel Detector 30x30 cm / 20x20 cm
<b>II format</b>	Availbale also with Image Intensifier 9" and 13"



#### Highlights

The new solution for the market demand: higher features at a lower price! Excellent manouvrrability with a slim-line design.

- Up to 1,000 mA, 100 kW power
- Liquid cooled X-ray tube
- Suspended LCD screens
- Control room screens
- E-motion remote control (all C-arm movements are motorized)
- DICOM interface

#### INTERMEDICAL · RADIUS XP 100 CARDIO – FLOOR BASED

<b>Power</b>	100 kW
<b>Detector</b>	Digital Flat Panel Detector 30x30 cm / 20x20 cm
<b>II format</b>	Availbale also with Image Intensifier 9" and 13"



#### Highlights

The new solution for the market demand: higher features at a lower price! Excellent manouvrrability with a slim-line design.

- Up to 1,000 mA, 100 kW power
- Liquid cooled X-ray tube
- Suspended LCD screens
- Control room screens
- DICOM interface
- E-motion remote control (all C-arm movements are motorized)



**Medtronic · O-arm System**

**Power** 32 kW  
**Detector** Digital flat panel detector 30x40 cm



**Highlights**

- 13s 3D scan – Fully mobile – Flexible intra-operative 2D- and 3D-imaging
- Large 2D-image size and large 3D scan volume
- Seamless integration in OR workflow
- Easy in use: All motions motorized, simple control panel
- Position memory remembers scan positions
- 4 preset 3D scan modes
- Easy draping of the breakable gantry
- Seamless integrating with Stealth-Station Navigation
- Full DICOM3 + USB

**Shimadzu · BRANSIST alexa C12**

**Resolution** 2.58 Lp/mm  
**Detector** Dynamic flat panel detector (CsI)  
**Size** 12" x 12" (30x30 cm)



**Highlights**

- Ceiling-mounted C-arm
- Wide coverage of C-arm (287 cm longitudinal and 160 cm transverse movement)
- Direct Memory offers unsurpassable ease of operation
- Unique pioneering imaging technology – RSM-DSA
- SUREngine: realtime image enhancement processing

**Shimadzu · BRANSIST alexa F12**

**Resolution** 2.58 Lp/mm  
**Detector** Dynamic flat panel detector (CsI)  
**Size** 12" x 12" (30x30 cm)

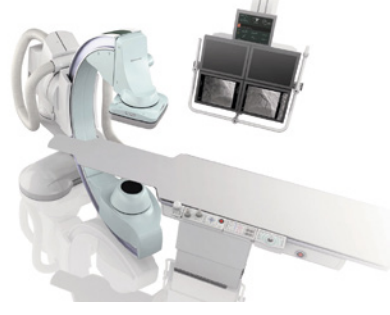

**Highlights**

- Floor-mounted C-arm
- High sensitive detector technology for outstanding image quality
- Six-axis triple-pivot construction for wide body coverage
- SUREngine: realtime image enhancement processing
- Unique pioneering imaging technology – RSM-DSA

**Shimadzu · Trinias C12/C8**

**Resolution** 2.58 Lp/mm  
**Detector** Dynamic flat panel detector (CsI)  
**Size** 12" x 12" (30x30 cm) / 8" x 8" (20x20 cm)



**Highlights**

- Wide coverage for smooth operability
- SCORE PRO Advance image processing technology
- Unique pioneering imaging technology: motion-tolerant SCORE RSM
- SCORE StentView
- SCORE CT
- SCORE 3D
- SCORE Navigation
- SMART design concept
- Comprehensive dose management package

**Shimadzu · Trinias F12/F8**

**Resolution** 2.58 Lp/mm  
**Detector** Dynamic flat panel detector (CsI)  
**Size** 12" x 12" (30x30 cm) / 8" x 8" (20x20 cm)



**Highlights**

- Wide coverage for smooth operability
- SCORE PRO Advance image processing technology
- Unique pioneering imaging technology: motion-tolerant SCORE RSM
- SCORE StentView
- SCORE CT
- SCORE 3D
- SCORE Navigation
- SMART design concept
- Comprehensive dose management package

**Siemens · Artis floor**

**Power** 100 kW  
**Detector** a-Si / CsI, 20x20 (1,024x1,024 pixels), 184 µm  
a-Si / CsI, 30x40 (1,920x2,480 pixels), 154 µm  
zen30HDR, hi-res crystalline silicon / CsI, (1,792 x 1,632 pixels), 160 µm

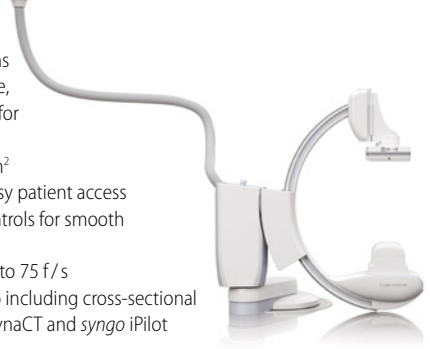

**Highlights**

The Artis floor-mounted system enables clinicians to care with greater ease, precision and flexibility for small rooms.

- Small footprint of 29 m<sup>2</sup>
- Slim-line design for easy patient access
- Ergonomic system controls for smooth table-side operation
- 3D acquisition rate up to 75 f/s
- Complete 3D-portfolio including cross-sectional imaging with *syngo* DynaCT and *syngo* iPilot (3D-roadmapping)

# INTERVENTIONAL SYSTEMS

## SINGLE PLANE

### Siemens · Artis ceiling

**Power** 100 kW  
**Detector** a-Si / Csl, 20x20 (1,024x1,024 pixels), 184 µm  
 a-Si / Csl, 30x40 (1,920x2,480 pixels), 154 µm  
 zen30HDR, hi-res crystalline silicon / Csl, (1,792x1,632 pixels), 160 µm

#### Highlights

The Artis ceiling-mounted system enables clinicians to care with greater ease, precision and flexibility.

- Positioning flexibility that supports any angle
- Ergonomic system controls for smooth table-side operation
- 3D acquisition rate up to 75 f/s
- Complete 3D-portfolio including cross-sectional imaging with *syngo DynaCT* and *syngo iPilot* (3D-roadmapping)



### Siemens · Artis one

**Power** 100 kW  
**Detector** as30, a-Si / Csl, (1,560x1,420 pixels), 184 µm



#### Highlights

- Intelligent operation is enhanced by a configurable head up display, allowing you to interact with the system in a completely new, intuitive way.
- Ergonomic system controls for smooth table-side operation
- Full patient coverage imaging up to 2.10 m
- Integrated 3D-Imaging and review with acquisition rate up to 66 f/s
- Slim-line design for easy patient access

### Siemens · Artis zeego

**Power** 100 kW  
**Detector** a-Si with Csl scintillator, 30x40 (1,920x2,480 pixels), 154 µm  
 zen30HDR, high-resolution crystalline silicon with Csl scintillator, (1,792x1,632 pixels), 160 µm

#### Highlights

The Artis zeego takes performance and precision to an unprecedented level.

- Performance with a new imaging chain with new applications
- Positioning flexibility that supports any angle
- Ergonomic system controls for smooth table-side operation
- 3D acquisition rate up to 75 f/s
- Complete 3D-portfolio including cross-sectional imaging with *syngo DynaCT* and *syngo iPilot* (3D-roadmapping)



### Siemens AG · Artis zee multipurpose System

**Power** 100 kW  
**Detector** a-Si / Csl, 30x40 (1,920x2,480 pixels), 154 µm

#### Highlights

- Artis zee multi-purpose is designed to meet the escalating demands of interventional radiology, fluoroscopy and interventional cardiology. The system left suspension meets the needs of endoscopic applications in gastroenterology
- Ergonomic system controls for smooth table-side operation
- 2 k imaging with highly practical and user-friendly handling features
- 3D acquisition rate up to 60 f/s



### Toshiba · Infinix CC-i

**Power** 100 kW  
**Detector** 20x20 cm flat panel detector  
**Pixel size** 194 µm



#### Highlights

Cardio intervention demands speed, precision, and optimum performance. The Infinix CC-i is designed to take advantage of the latest technological innovations to reduce dose and to save time. A revolutionary graphic user interface and a multi-tasking computer enable the system to fully meet the requirement for optimum image quality, safety, ease of use, advanced efficiency and improved workflow.

### Toshiba · Infinix CF-i/SP

**Power** 100 kW  
**Detector** 20x20 cm flat panel detector  
**Pixel size** 194 µm



#### Highlights

Cardio intervention demands speed, precision, and optimum performance. The Infinix CF-i/SP is designed to take advantage of the latest technological innovations to reduce dose and to save time. A revolutionary graphic user interface and a multi-tasking computer enable the system to fully meet the requirement for optimum image quality, safety, ease of use, advanced efficiency and improved workflow.

**Toshiba · Infinix OR**

**Power** 100 kW  
**Detector** 30x40 , 30x30 , 20x20 cm Csl flat panel detector  
**Pixel size** 194 µm

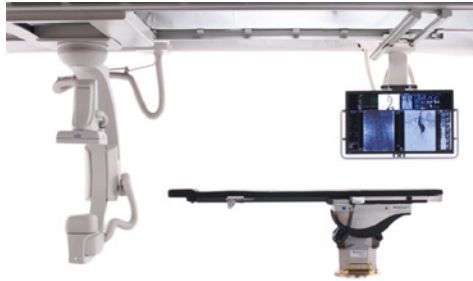

**Highlights**

The combination of the Infinix VC-i with the fully integrated dedicated surgical table Maquet Magnus perfectly meets the requirements of the rapidly growing demand for hybrid procedures. It offers patient access from all sides which eliminates the need to move table or patient. The system is available in three different detector sizes : 20x20 cm, 30x30 cm and 30x40cm.

**Toshiba · Infinix VC-i**

**Power** 100 kW  
**Detector** 30 x 30 cm or 30x40 cm flat panel detector  
**Pixel size** 194 µm

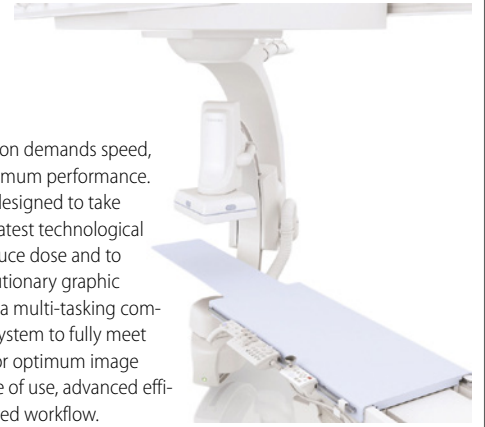

**Highlights**

Vascular intervention demands speed, precision, and optimum performance. The Infinix VC-i is designed to take advantage of the latest technological innovations to reduce dose and to save time. A revolutionary graphic user interface and a multi-tasking computer enable the system to fully meet the requirement for optimum image quality, safety, ease of use, advanced efficiency and improved workflow.

**Toshiba · Infinix VF-i/SP**

**Power** 100 kW  
**Detector** 30x30 cm or 30x40 cm flat panel detector  
**Pixel size** 194 µm



**Highlights**

Vascular intervention demands speed, precision, and optimum performance. The Infinix VF-i/SP is designed to take advantage of the latest technological innovations to reduce dose and to save time. A revolutionary graphic user interface and a multi-tasking computer enable the system to fully meet the requirement for optimum image quality, safety, ease of use, efficiency and improved workflow.

**Wandong · CGO-2100 FPD – Angiographic and Cardiac System**

**Power** 100 kW / 200 kHz  
**Detector** 40x30 cm / 20x20 cm FPD



**Highlights**

- 100 kW / 200 kHz generator
- 0.3 / 1.0 mm, 2.0 MHU X-ray tube assembly
- Floor mounted C-arm, large range of movement along three axes, affiliated with longitudinal movement of cath-table enables more clinic applications
- Cath-Table: four way movement of table-top, motorized up/down movement
- 40x30 / 20x20cm FPD, 30 fps image acquisition rate, 14-bit grey scale
- InvaRay digital imaging platform, DICOM 3.0 fully support

**SURGICAL II-C-ARMS**

**DMS / APELEM · EVO+ / EVO R+**

**Power** Up to 5 kW  
**II format** 9" or 12"  
**Resolution** 1,024 x 1,024 pixels

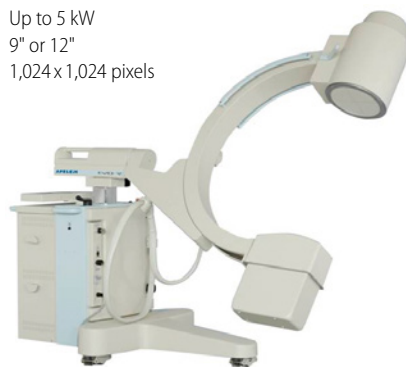

**Highlights**

- The EVO and the EVO-R C-arm units include a microprocessor controlled high frequency generator and a fixed anode tube for EVO version and a rotating anode tube for EVO-R.
- Both systems have "Digital memory systems" and "Digital subtraction angiography" (DSA) and have been conceived for a large range of applications, including traumatology, endoscopy, intensive care and interventional procedures.

**GE Healthcare · OEC 9900 Elite**

**Power** 15 kW  
**II format** 11 cm, 15 cm, 23 cm and 31 cm  
**Resolution** 1,024 x 1,024 px



**Highlights**

- DRM (Dynamic Range Management)
- Intuitive touchscreen interface
- Comfortable viewing with flat screen monitors
- Easy archiving: CD / DVD and DICOM
- Fully motorized imaging system

# INTERVENTIONAL SYSTEMS

## SURGICAL II-C-ARMS

### GE Healthcare · OEC Brivo Plus

<b>Power</b>	2.2 kW
<b>II format</b>	9" or 23 cm
<b>Resolution</b>	1 kx 1 k
<b>Field of View</b>	11 cm, 15 cm or 23 cm



#### Highlights

- 1 kx 1 k high resolution from a fully digital image processing system
- 9" Image Intensifier with high spatial resolution
- Brilliant radiation safety features
- Carbon fiber grid
- Available Pediatric package
- Intuitive user interface with touch screen
- Advanced connectivity including wireless DICOM, MPPS and DVI options
- Data protection including a UPS

### GE Healthcare · OEC FluoroStar 7900

<b>Power</b>	2.2 kW
<b>II format</b>	9" or 23 cm
<b>Resolution</b>	1,024 x 1,280 pixel
<b>Field of View</b>	11 cm, 15 cm and 23 cm



#### Highlights

- Imaging excellence for confidence in surgery
- Touch screen interface for simplicity and ease of use
- CD / DVD recording device with PC-based operation
- USB port for plug-and-play image storage
- Sleek, high-quality flat panel display
- Available as a Compact configuration with 1 or 2 monitors or with optional monitor cart (Compact2, Compact+ and Series)

### GMM · SYMBOL – Mobile C-arm unit with Image Intensifier

<b>Design</b>	Mobile C-arm unit
<b>II format</b>	9" / 12" / 13"



#### Highlights

- Innovative mobile C-arm unit for outstanding performances and superior image quality in any imaging activity in operating room.
- Provided with High Frequency generator and ample C-arm allowing wide and extended movements.
- Outstanding flexibility and precision in any type of projection are ensured also by 146° orbital movement with 56° overscan.
- 9" to 13" triple field Image Intensifier, 1K CCD

### INTERMEDICAL · RADIUS DFG

<b>II format</b>	9" and 12"
<b>Power</b>	5 kW
<b>Resolution</b>	6.4 Lp / mm (9"); 5.6 Lp / mm (12")



#### Highlights

- Modular configurations, from the base one to the top one (DSA Full), even after-sale, just with a USB-key-hardware.
- Progressive scan CCD digital camera 1kx 1k
- Memory capacity: more than 350,000 images
- 40 kHz X-ray monoblock generator, 120 kV, rotating anode
- Memory configurations:
  - DFG Base (15 frames / second); DFG Vascular (30 frames / second)
- DICOM 3

### INTERMEDICAL · RADIUS XP

<b>Power</b>	20 kW
<b>II format</b>	9" and 13"
<b>Resolution</b>	6.5 Lp / mm (9"); 6 Lp / mm (13")



#### Highlights

- Large Power reserve of 20 kW
- Excellent 1 kx 1 k image quality
- configurations suitable for all the examinations
- 12, 25 or 30 frames / sec. image acquisition depending on the chosen software
- E-motion: all C-arm movements can be motorized
- Dual Cooling System: liquid-to-air heat exchanger
- Dual Power System: power reserve system

### medifa-hesse · MRT5600 II

<b>Length x Width:</b>	2,340 x 500 mm
<b>Lead Equivalent</b>	1.0 mm / 100 kV
<b>Power</b>	300 W (line) or battery



#### Highlights

- Table top as well as rails at head end and beside the lying surface are made of carbon fiber for excellent usage of C-arms
- Height adjustment, Trendelenburg positioning, lateral tilt and sliding of table top by hand switch or operating panel at the column
- Longitudinal as well as transversal slide of table top additionally by joystick
- Supports patients weight up to 250 kg in each position





**RAD** BOOK 2015

Please visit us at  
[www.healthcare-in-europe.com](http://www.healthcare-in-europe.com)

**Shimadzu · Opescope Acteno**

**Resolution** CCD-Sensor, 1,024x 1,024x 12 bit  
**II format** 23 or 15 cm  
**Power** 2 kW



- Highlights**
- High quality imaging
  - Easy operation through fully balanced C-arm
  - Magnetic locks and all-free buttons
  - Memory functions support an efficient workflow

- Inside C-arm cabelling
- Flexible upgradeability

**Siemens · Arcadis Avantic**

**Power** 25 kW  
**II format** 33 cm



- Highlights**
- Cutting-edge mobile imaging with a larger field of view
- Large 33 cm (13") image intensifier
  - Powerful 25 kW generator with tube currents of up to 250 mA
  - 2.57 MHU (Mega Heat Units) heat capacity
  - EASY (Enhanced Acquisition System) with automatic dose, contrast and brightness control
  - Electromagnetic brakes, multifunctional footswitch (option) and remote user interface (option) for control from within the sterile field

**Siemens · Arcadis Orbic**

**Power** 2.3 kW  
**II format** 23 cm  
**Resolution** 1.8 Lp/mm



- Highlights**
- Arcadis Orbic – Enhanced precision in the OR
- Counterbalanced, isocentric design C-arm with intelligent color coding for fast and precise positioning
  - 190° isocentric orbital rotation
  - Tube currents of up to 23 mA
  - EASY (Enhanced Acquisition System) with automatic dose, contrast and brightness control

**Siemens · Arcadis Orbic 3D**

**Power** 2.3 kW  
**II format** 23 cm



- Highlights**
- Arcadis Orbic 3D – Enhanced precision in the OR
- Isocentric design and 190° orbital movement optimizing intraoperative 3D imaging
  - Streamlined workflow with fast positioning, scan and reconstruction time
  - Intraoperative 3D evaluation and revisions reduce rate of second interventions
  - Direct connection to navigation systems via Navilink 3D (option)

**Siemens · Arcadis Varic**

**Power** 2.3 kW  
**II format** 23 cm



- Highlights**
- Streamlined workflow and outstanding image quality in the OR
  - EASY (Enhanced Acquisition System) with automatic dose, contrast and brightness control
  - Fully digital 1K<sup>2</sup> imaging chain from acquisition to viewing and archiving
  - Counterbalanced C-arm design with optimized free space, immersion depth, and overscan
  - 1K<sup>2</sup> navigation interface Navilink 2D (option)

# INTERVENTIONAL SYSTEMS

## SURGICAL II-C-ARMS

### Siemens · Siremobil Compact L

**Power** 1.4 kW  
**II format** 23 cm

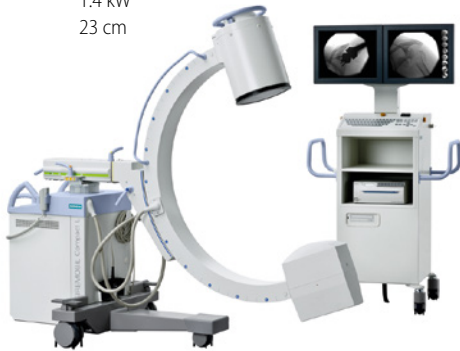

#### Highlights

- Siremobil Compact L – The compact all-rounder for surgical imaging
- Extended fluoro times of more than 50 mins
  - Counterbalanced C-arm with a large orbital rotation of 130°
  - Ergonomic and space-saving monitor cart
  - Consistent digital 1K<sup>2</sup> imaging chain

### STEPHANIX · OMNISCOP Series

**Design** Mobile surgical C-arm  
**Power** up to 15 kW  
**II format** 9" / 12"



#### Highlights

- Surgery, traumatology, orthopedics, vascular ...
- Wide range of movements, large orbital rotation, small footprint
- High resolution CCD camera coupled with Thales Image Intensifier
- Collimator with motorised and rotating iris, continuously adjustable
- Touch screen user interface
- Post-processing software highlight tiny details
- Advanced functions: APR, DSA, DICOM connectivity

### Technix · TCA6

**Design** 9" surgical C-arm equipped with 0.5 k x 0.5 k camera  
**Power** 3.5 kW (TCA6 S) / 5 kW (TCA6 R)  
**II format** 23 cm



#### Highlights

- Stationary anode (TCA6 S) / Rotating anode (TCA6 R)
- 0.5 k x 0.5 k camera
- Image storage: LIH + 330 / 2700 / 110.000
- Up to 25 fps acquisition
- Compact version without cart and 19" LCD monitor on-board / Lightweight cart with 19" LCD monitors
- Optional ± 30° motorized rotation for lithotripsy interventions
- DICOM connectivity (LAN or wireless)
- DSA, roadmap, stenosis analysis

### Technix · TCA6 – high configuration

**Design** 9" / 12" surgical C-arm equipped with 1 k x 1 k camera  
**Power** Up to 15 kW  
**II format** 23 / 32 cm



#### Highlights

- Rotating anode
- Water cooling
- 1 k x 1 k camera
- Image storage: up to 110.000
- High configuration cart with 19" monochromatic LCD monitors
- Acquisition up to 25 fps
- Anatomical programs
- DICOM connectivity (LAN or wireless)
- CD / DVD and USB for image exporting
- Remote control
- Laser for patient centering
- Virtual collimators (for dose reduction)
- DSA, roadmap, stenosis analysis

### VILLA SISTEMI MEDICALI · Arcovis 3000 S / R

**Power** 3.5 kW (fixed anode) / 5 kW (rotating anode)  
**II format** 9" / 12"  
**Resolution** 48 / 56 / 64 Lp / cm (9" II.) – 48 / 54 / 62 Lp / cm (12" II.)



#### Highlights

- Application in urology, cardiology, orthopedics and general surgery
- Perfect balance between image quality and ergonomics
- Choice between fixed anode (3000 S) or rotating anode (3000 R) versions
- Choice between either 9" II. (with stationary or rotating anode) or 12" II. (with rotating anode)
- Choice of 0.5 k x 0.5 k or 1 k x 1 k camera and several image storage options to satisfy all applications

### VILLA SISTEMI MEDICALI · Arcovis 3000 S Compact

**Power** 3.5 kW  
**II format** 9"  
**Resolution** 48 / 56 / 64 Lp / cm



#### Highlights

- Compact C-arm unit available with 9" II. and stationary anode tube
- Equipped with an on-board 17" LCD monitor, not requiring external displays on trolley
- Last Image Hold and storage system based on non-volatile technology
- ± 60° rotating control panel for immediate operation even in the most difficult environment

**Wandong · XC30**

**Power** 5 kW  
**II format** 9 inch

**Highlights**

XC series mobile C-arm system can be used mainly for fluoroscopy and radiography in the operation room, emergency ward, orthopedics and surgical treatment. Apply high frequency conversion technology, greatly improve image quality, shorten exposure time, and reduce the harmful radiation to human body. Ergonomics designed, compact structure, Microcomputer-control, easy to operate, maintain and move.



**Ziehm · Solo**

**Resolution** 21 cm – 2.0 Lp/mm · 16 cm – 2.5 Lp/mm  
 11.5 cm – 3.1 Lp/mm  
**II format** 23 cm  
**Power** 2 kW

**Highlights**

Ziehm Solo is the first choice for small operating rooms. The single unit comprises a compact and versatile C-arm, full-size monitor and intuitive touchscreen user interface. All functions required for an optimal image acquisition, processing and archiving are integrated in the C-arm. Ziehm Solo delivers optimal performance for pain management, orthopedics and lithotripsy.



**Ziehm · Vision R**

**Resolution** 21 cm – 2.0 Lp/mm · 16 cm – 2.5 Lp/mm  
 11.5 cm – 3.1 Lp/mm · 27.5 cm – 1.6 Lp/mm  
 21 cm – 2.0 Lp/mm · 16 cm – 2.5 Lp/mm  
**II format** 23 cm, 31 cm  
**Power** 7.5 kW



**Highlights**

Ziehm Vision R is the perfect choice for demanding procedures in neurosurgery, vascular procedures and cardiac applications. The powerful monoblock generator with rotating anode delivers up to 20 kW power, enabling Ziehm Vision R to produce high-quality images with minimal dose exposure. This high-frequency pulse generator operates with a variable pulse width between 4 ms and 50 ms.

**SURGICAL FLAT PANEL C-ARM**

**GMM · SYMBOL – Mobile C-arm system with DFPD**

**Size** 26x30 cm  
**Resolution** 184 μm  
**Detector** Amorphous silicon



**Highlights**

- State-of-the-art flat panel technology for outstanding performances and superior image quality for any imaging activity in operating room.
- General and vascular surgery, neurosurgery, cardiology, gastroenterology, urology.
- Easy patient positioning thanks to the wide C-arm opening.
- Exclusive user interface with LCD touch screen display ensuring complete management of the operating parameters.

**Hologic · InSight-FD Mini C-arm System**



**Highlights**

The Fluoroscan InSight-FD mini C-arm system with flat detector technology offers thin profile and improved workspace access while providing ease of positioning

- Ergonomic flat detector design with ease of positioning for patient/surgeon access
- Forward tube source design offers greater C-arm depth
- Flat detector technology with 75 micron array and 2 k x 1.5 k resolution

**INTERMEDICAL · RADIUS XP (MODEL WITH FLAT PANEL)**

**Pixel size** 1,536 x 1,536 pixels  
**Detector** Digital Flat Panel Detector 30 x 30 cm / 20 x 20 cm  
**Power** 20 kW



**Highlights**

- Large Power reserve of 20 kW
- Excellent 1,536x1,536 pixels image quality
- Outstanding versatility: flexible configurations suitable for all the examinations
- 12/30 frames sec. image acquisition
- E-motion: all C-arm movements can be motorized
- Dual Cooling System: liquid-to-air heat exchanger
- Dual Power System: power reserve system

# INTERVENTIONAL SYSTEMS

## SURGICAL FLAT PANEL C-ARMS

### Primax · CYBERBLOC

**Power** up to 15 kW  
**Detector** New Flat Panel Generation  
**Design** Chassis of light aluminum alloy for easy positioning

#### Highlights

- Large C-arm depth for maximum accessibility
- High sensitivity → low dose operation
- Smart power management to handle long procedures
- Full touch "smart" user interface
- View station with angle and height adjustments
- Removable grid for paediatric applications
- Image free of any distortion



### Siemens · Cios Alpha

**Power** 12 kW or optional 25 kW  
**Detector** 20 x 20 cm or optional 30 x 30 cm  
**Pixel size** 194 µm

#### Highlights

- Cios Alpha – See the power with Full View FD
- Full View FD for outstanding image quality and up to 25 % more coverage\*
  - Retina Imaging Chain for high-quality images at very low dose
  - One of the most powerful 25 kW (option) mobile C-arms, to see and do more
  - Full table-side control and single-touch positioning (option) for effortless operability

\* Compared to today's conventional image intensifiers



### Ziehm · Vision FD Vario 3D

**Resolution** 1,024 x 1,024  
**Detector** a-Si; 20 cm x 20 cm  
**Power** 2 kW  
**Pixel size** 194 µm

#### Highlights

Ziehm Vision FD Vario 3D integrates multiplanar reconstructions and 3D volume rendering into a space-saving design. Equipped with flat-panel technology, the system delivers more than 16,000 shades of gray. The crystal-clear and distortion-free 3D images provide maximum intraoperative visualization of anatomical structures. The CTlike reconstructions can be combined with navigation systems.



### Ziehm · Vision RFD

**Resolution** 1,536 x 1,536  
**Detector** a-Si; 30 cm x 30 cm / 20 cm x 20 cm  
**Power** 20 kW  
**Pixel size** 194 µm

#### Highlights

Ziehm Vision RFD offers a viewing experience previously only available with larger stationary imaging systems. With its powerful monoblock generator with a rotating anode and the unique liquid cooling system it is specially designed for extended use in operating theaters, making Ziehm Vision RFD ideal for demanding interventions such as AAA procedures.



### Ziehm · Vision RFD 3D

**Resolution** 1,536 x 1,536  
**Detector** a-Si; 30 cm x 30 cm / 20 cm x 20 cm  
**Power** 25 kW  
**Pixel size** 194 µm

#### Highlights

Ziehm Vision RFD 3D is the only 3D C-arm worldwide with flat-panel technology that provides a 16 cm edge length per scan volume. It combines 2D and 3D functionality to offer maximum ease-of-use. Available with 30 cm x 30 cm or 20 cm x 20 cm flat-panels, the C-arm offers game-changing 3D imaging and is ideally suited for orthopedics, traumatology and spinal surgery.



### Ziehm · Ziehm Vision RFD Hybrid Edition

**Resolution** 1,536 x 1,536  
**Detector** a-Si; 30 cm x 30 cm / 20 cm x 20 cm  
**Power** 25 kW  
**Pixel size** 194 µm

#### Highlights

Ziehm Vision RFD Hybrid Edition is the first mobile C-arm offering motorization of all four axes. The movements can be steered with the Position Control Center directly from the sterile field. The newly developed 25 kW generator is one of the most powerful in the market of mobile imaging and delivers crystal-clear images. Outstanding imaging performance is crucial in hybrid room applications.





ACCESSORIES / COMPLEMENTARY SYSTEMS

Alliance · Flexible diagnostic imaging services



**Highlights**

- Static diagnostic imaging centers MRI, CT, PET, PET/CT, Cath Lab
- Interim services for bridging downtimes
- Regular "routing" services

Esaote · Echolaser

**Design Power**

Premium multi-disciplinary ultrasound system + Laser unit  
Solid state Laser at 1,064 nm, 4 sources 7 W Max each

**Highlights**

- Echolaser is a complete interventional ultrasound-laser All-in-One system for minimally invasive thermal ablation procedures; it comes with disposable optical fibre kits designed for the various organs together with specific guiding systems.
- The main applications currently involve the reduction of benign thyroid nodules and the destruction of primary and secondary malignant liver lesions.



GCTechnology · CIRS Phantoms



**Highlights**

- Multi modality abdominal biopsy phantom (for CT, US, MRI)
- Multi modality lumbar training phantom
- Biopsy breast phantom
- Thyroid training phantom
- Prostate training phantoms family
- Kidney training Phantom
- Vascular Access Training Phantom

I.A.E. · SpA C30-RTM 70



**Highlights**

- Rotating anode X-Ray tube unit designed for mobile c-arm equipment
- Lead lined single piece aluminum body, internal pump for oil circulation, to improve thermal exchange
- Choice of HT cable socket: Parker or Claymount mini
- Optional remote water-air heat exchanger increases heat dissipation to 500W continuous for demanding interventional applications
- Water cooling can be mounted or upgraded on field

Toshiba Electron Tubes & Devices · 9 inch X-ray Image Intensifier

**Detector**

X-ray Image Intensifier

**Size**

Field size 9 inch , 9/6/4.5 Inch  
Output image Size Ø 20 mm , Ø 25 mm

**Design**

For C-Arm



**Highlights**

- Suitable for mobile C-arms
- Smart design with smooth surfaces
- Environmentally friendly
- Excellent performance and high reliability
- Compliant with the RoHS directive
- Advanced simulation technologies used in development and production
- Our unique technologies provide a high Gx value, reducing radiation exposure to the patient.
- Free from hazardous substances such as hexavalent chromium and cadmium

Toshiba Electron Tubes & Devices · Angio Tube assembly

**Power**

3-MHU (Anode Heat Capacity)  
80 kW – 102 kW



**Highlights**

- For angiography systems (3-MHU)
- Uses a liquid metal bearing
- This X-ray tube assembly with liquid metal bearing provides a long tube life, quiet operation, continuous high-speed rotation, high stability, and excellent reliability.

# IT Systems

**Canon**

**AGFA** *Agfa*  
HealthCare



**FUJIFILM**

**e bit**  
an Esaote Group Company



**HOLOGIC**

**i-SOLUTIONS**  
HEALTH



**IMAGE**  
Information  
Systems

**medigration**  
The Digital Company  
ein Unternehmen der bender gruppe



**SECTRA**

**PROTEC**  
TEAM | SPIRIT | ABILITY

**SIEMENS**

**TERARECON**

**VISUS**

**VITAL**  
A Toshiba Medical Systems Group Company

RIS / PACS

Agfa · Enterprise Imaging Radiology Suite

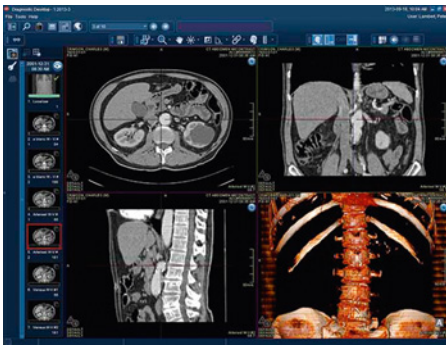

**Highlights**

Agfa HealthCare Enterprise Imaging for Radiology is a unified imaging management platform that provides PACS, reporting, advanced image processing capabilities and integration of clinical information. The solution offers diagnostic tools and powerful task-based workflow, designed to achieve gains in clinical productivity.

Agfa · Enterprise Imaging Suite



**Highlights**

Agfa HealthCare Enterprise Imaging solution is a single imaging platform that allows any physician, across the department, hospital or regional network, to create, exchange, view and manage a comprehensive medical imaging record. It enables storage and access to relevant clinical imaging data from multiple departments for improved care delivery and multidisciplinary collaboration.

CHILI · Diagnost



**Highlights**

- Independent of modality
- CT, MR, CR, DR, PET, PET-CT, US, AX, ...
- Mammography
- Radio therapy
- Powerful hanging protocols
- Independent of OS
- Integrated teleradiology
- Extensible by other applications,
- HIS / RIS integration
- Consultation functionalities
- Teleconferencing

**Buy & sell used equipment on**



[www.dotmed.com](http://www.dotmed.com)

**Over 400,000 listings**  
**Over 20,000 daily visitors**

CHILI · Import PACS

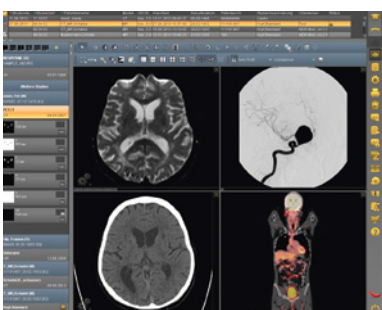

**Highlights**

- PACS for foreign data from CD / teleradiology
- Temporary archive in addition to regular PACS
- Manual web-based import
- Automatic import with import robotic
- Web-based viewer
- Data reconciliation with own IDs
- Delivery to regular PACS
- Adjustable automatic data removal
- DICOM Q/R capable
- Works with any other PACS

CHILI · PACS

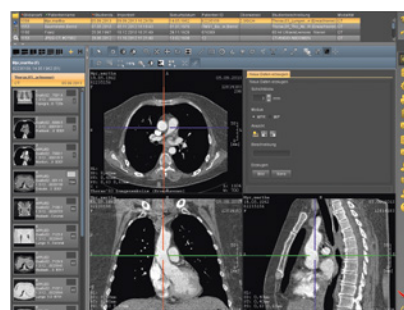

**Highlights**

- Multimedia PACS
- One viewer for all areas
- Scalable (practice to enterprise)
- For multi center enterprises
- Fail over and load balancing
- Interfaces to HIS / RIS
- Synchronisation with HIS / RIS
- Archiving in existing systems
- Web-based image distribution
- Referring physician access
- Teleconferencing
- Consultation
- Portal functionality

RIS/PACS

CHILI · Teleradiology Gateway

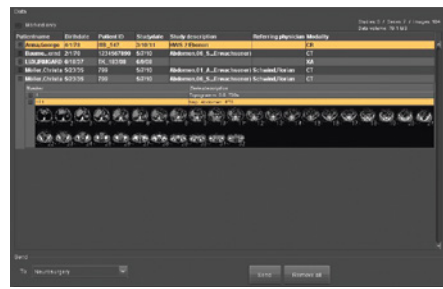

Highlights

- Vendor-independent protocols
- DICOM, DICOM-E-Mail, https, ...
- Rule-based autorouting
- Automatic recovery after interruption
- Comprehensive security measures
- Adjustable lossy and lossless compression
- Data encryption
- Audit trails
- Diagnostic web-viewer
- Web-based administration
- Compliant to German Röntgenverordnung
- Compliant to German DIN 6868-159
- Works with any PACS

CHILI · Web

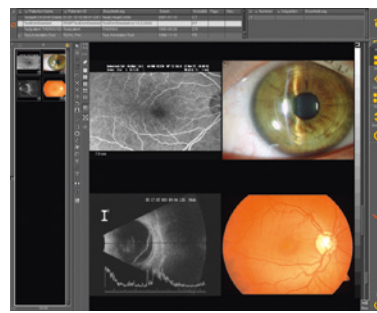

Highlights

- Multi-media (DICOM, jpeg, avi, PDF, ...)
- Modality independent
- Very well suited for teleradiology
- Referring physician access
- Independent of hardware and OS
- Java technology
- User concept with roles and rights
- Central user administration (LDAP, AD)
- Security measures
- Data compression (lossy & lossless)
- Suited for reporting
- Medical product class IIb
- Works with any PACS

Ebit · SUITESTENSA Mobile PACS



Highlights

- The newest frontier of mobile PACS connection anytime-anywhere
- Works on modern web browsers, IOS & Android mobile devices, Laptop-Desktop PC
- Supported OS: Windows, Mac OS
- Same image simultaneous management from different access points
- Unparallel security
- Predefined workspaces and data display as previously assigned to the image modality
- Interactive 2D, 3D & MIP / MPR, 3D Vol Rendering
- Digital slow motion

Ebit · SUITESTENSA RIS PACS

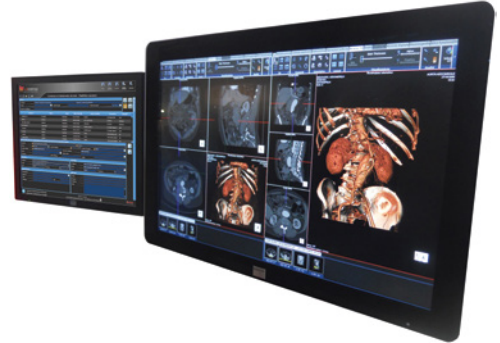

Highlights

SUITESTENSA is the RIS PACS imaging & information management SW platform bridging RIS PACS and applications. Using web-enabled technology, it exploits DICOM 3.0, HL7 and FDA-XML comm protocols. It implements Structured Report, 3D & 4D for CT / MR / PET and mobile PACS tech-gy. Dedicated to Radio, Nuclear Med, Radiotherapy, Breast Med, Interventional, Ortho, OR, with admin, reporting and post-processing.

FUJIFILM · SYNAPSE

SYNAPSE

Highlights

- Foundation Technologies
- Synapse is a collection of software modules providing PACS features to single or group of hospitals
- Fujifilm's Next Generation PACS
- Synapse Workstation Software is the multi-modality diagnostic viewing solution. Synapse Workstation Software provides viewing and manipulation of radiological data including images, reports, patient status and clinical information.

FUJIFILM · SYNAPSE Cardiovascular

SYNAPSE  
cardiovascular

Highlights

Developed with direction from cardiologists, Synapse Cardiovascular offers capabilities and tools that help streamline workflow, image review, and reporting for a variety of cardiac areas like cardiac catheterization, ECG management, echocardiography, nuclear cardiology and vascular ultrasound.



## FUJIFILM · SYNAPSE Teaching File

# SYNAPSE

**Highlights**

- Virtual archive for scientific and clinical purposes
- This web application for managing large amounts of information, allowing the searching, consultation and sharing of diagnostic studies, searched by free text within the study data stored on the Synapse PACS system.

# RAD BOOK 2015

Please visit us at

[www.healthcare-in-europe.com](http://www.healthcare-in-europe.com)

## GE Healthcare · Centricity Clinical Archive

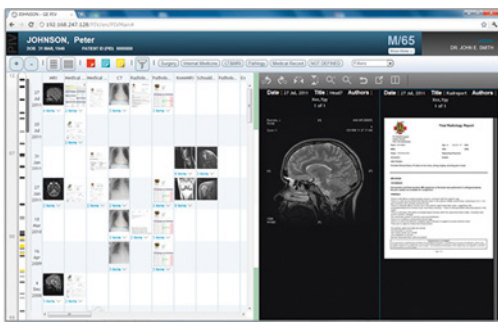
**Highlights**

- A highly scalable repository
- Intelligent image lifecycle management capabilities
- Flexible tools to help consolidate and manage a variety of application data across multiple departments, specialties, hospitals and regions
- IHE-XDS support
- Intuitive, zero foot-print, non-diagnostic clinician viewer
- Interfaces with electronic medical records to provide a single point of access viewing patient's images and associated clinical doc

## GE Healthcare · Centricity PACS / Centricity PACS IW

**Highlights**

- Intelligent productivity tools, including smart hanging protocols
- Advanced Visualization applications, including oncology; powered by AW
- Breast Imaging Workflow, including screening and diagnostic capabilities
- A common, streamlined, ergonomic user interface
- Access anywhere the Internet is available – web based, zero footprint and web client access

## GE Healthcare · Centricity RIS-i 5.0 with eRadCockpit

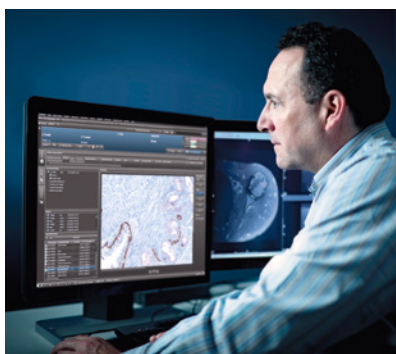
**Highlights**

- eRadCockpit reporting tool, RIS-i helps you to maximize efficiency by optimizing your workflow, connecting experts, balancing workloads and leveraging your existing infrastructure.
- MDT module connecting clinicians outside of radiology with Radiologists running the MDTs
- eRadCockpit
- e-Order review
- Embedded XDS consumer
- "Lights On, Lights Off" user view to improve reading comfort in multiple light settings

## IMAGE Information Systems · iQ-SYSTEM PACS

**Highlights**

iQ-SYSTEM PACS is an easily configurable, highly scalable picture archiving and communication system. It is installed in more than 5,000 facilities ranging from small, individual, imaging centers to large multi-modality, multi-site hospital installations across 97 countries. It is full-featured, state-of-the-art, robust and reliable, and available in most major world languages. The system is highly customizable with technical support provided by manufacturer-trained engineers.

RIS / PACS

i-SOLUTIONS · RadCentre Analytics

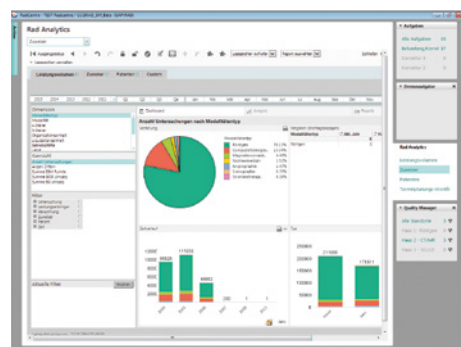

Highlights

RadCentre Analytics offers an integrated solution for specific data analysis and interactive reporting to increase performance in radiology.

- Predefined, high performance processing of operating figures
- Unlimited analysis options for optimisation of business outcomes
- Integrated data warehouse solution

i-SOLUTIONS · RadCentre Cockpit & Speech Integration

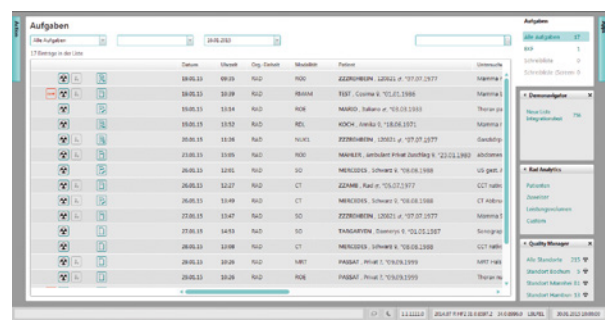

Highlights

RadCentre is a comprehensive process and data management solution for radiology, nuclear medicine and radiotherapy. Based on latest technologies it offers high usability with an innovative User Interface (Cockpit) and most efficient reporting with integrated speech recognition.

- Latest technology, highest usability
- Fast and efficient creation of reports for treatment without delay

ITZ Medicom · ITZ Hyper.PACS with archiving-system Hyper.ARC



Highlights

- One frontend and one database for all data
- ITZ-Parallel-Archiving-Concept; no archiving of errors like with backup-principle
- Fast shortterm – and fireproof longterm – archive
- Compliance to RgV and MDD Class IIb
- Fast, stable, save

medigration · RIS / PACS



Highlights

Our RIS / PACS solutions are designed for multisite and manufacturer-independent networks. The WinRadiolog RIS product portfolio implies the whole patient management for your medical institution. Our PACS product portfolio comprises a proven DICOM archive, an intuitive operating reporting 3D ImageVision workstation, teleimaging and mobile solutions, patient CD system and DICOM PaperPrint Server.

PROTEC · CONAXX 2



Highlights

User-friendly and intuitively operable software for the acquisition of X-ray images and operation of DR-modalities and X-ray generators.

- Automatic image optimisation
- Three clicks only to get your X-ray image
- Image diagnose directly in CONAXX 2 possible (optional/single workstation solution)
- Compatible with any DICOM PACS
- Extraordinary workflow efficiency

PROTEC · PROPAXX



Highlights

- Administrative and assisting functions, e.g. the integrated interface for reporting the clinical findings or synchronic viewing images
- Detailed 10-bit display of the X-ray images
- Configurable menu with guide access
- Individual system size: single or multiple workstations
- Individual system size as multi-user / multi-client PACS solution
- Integrated backup function

Everything at anytime

# Radiologists discover the benefits of a medical archive



Radiologists are forever looking for ways to optimize their processes. Now that applications for mobile devices provide location-independent access to images they seek to integrate other medical data which might be diagnostically relevant.

Mobile devices in healthcare facilities are more than a fad – they are here to stay. And after initial doubts IT experts and users alike now know exactly what mobile technology needs to offer to optimize processes. “The clients want applications that are platform-neutral and thus hardware-neutral. The users moreover have recognized that the real value add is generated by the integration of applications that are logically linked – such as integrating the PACS app into the HIS app,” says Willi Lohrke, Head of International Sales at VISUS whose JiveX Mobile product hits the mark. Based on HTML5 the application is platform-neutral and as a stand-alone application it can be linked to the PACS

of other vendors. In addition, the mobile viewer can be integrated into the apps of all renowned HIS vendors and provides access to image data straight from the mobile patient record.

## More than images: JiveX Medical Archive

The potential of JiveX Mobile however goes far beyond the mobile device. Combined with JiveX Medical Archive not only radiological data can be viewed in DICOM format but also those of other medical disciplines. This is an added value more and more radiologists appreciate not only with regard to their mobile devices as Willi Lohrke confirms: “When we started to develop an archive for hospital-wide image and medical data and to present them on a single viewer, we used our experience from radiology where we have learnt how

to handle standards such as DICOM or HL7, standards on which we have based JiveX Medical Archive. The radiologists in turn benefit from these developments: with the viewer they are used to they can access data in a format they are used to – namely DICOM – including data that were generated outside radiology such as cardiac cath lab data or medical reports which support their diagnostic work.”

JiveX Medical Archive can offer these functionalities because it is based exclusively on standards such as DICOM, HL7, HL7 CDA or PDF/A. Moreover it offers tools to convert non-standard data formats, for example those of ECGs, into a standard format.

Thus JiveX Medical Archive provides the framework for two tasks: the logical and time and money saving consolidation of different archives in a hospital and the cross-sector exchange of data. “Data exchange with referring physicians, other hospitals or healthcare facilities and medical offices plays an increasingly important role. This however requires a centralized infrastructure which forwards patient data in a logical way. DICOM format is ideally suited to take over this task because it ensures that patient context and patient data are always inextricably linked,” Willi Lohrke underlines.

Equally relevant in this context is another standard which is supported by JiveX Medical Archive: IHE-XDS (Cross Enterprise Document Sharing). It takes the idea of the medical archive to another level as it allows storing data in such a way that they can be made available not only within the hospital but across campus walls. For the hospitals, compliance with this standard not only optimizes the workflows, it also allows simple and system-independent data migration.

[www.visus.com](http://www.visus.com)



RIS / PACS

Sectra · Sectra RIS / PACS



**Highlights**

Sectra RIS / PACS is designed to shorten report turnaround time, enhance request and result distribution workflows, and improve communication and dialog between radiology and referring units. Highlights of Sectra RIS / PACS include: a complete PACS reporting module with voice recognition and server-based volume visualization with time-saving diagnostic tools for vessel analysis and bone segmentation.

Siemens · syngo Dynamics

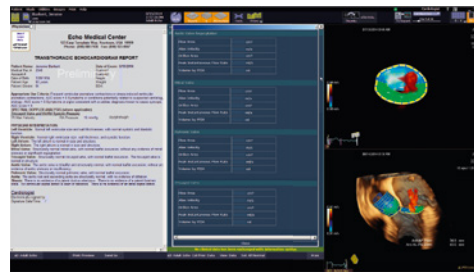

**Highlights**

syngo Dynamics enables enterprise-wide review of cardiovascular information which supports clinical efficiency.

- With syngo Dynamics you can rapidly read multi-modality images and create reports for your cardiovascular patients.
- Studies from across your enterprise can be accessed quickly, and are available at your fingertips.
- Customizable templates enable you to tailor evidence-based structured reporting to efficiently meet your needs and workflow.

Siemens · syngo.plaza

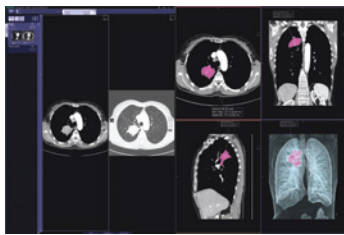

**Highlights**

syngo.plaza is the agile PACS and reading software, where 2D and 3D reading comes together in one place.

- It provides a wide range of applications and tools to support fast and efficient reading.
- High-throughput reading speeds up your workflow and an easy-to-manage IT environment helps save resources and effort.
- syngo.plaza 3D+ integrates syngo.via 3D functionality into the routine interpretation process of multiplanar images. 2D and 3D images are simultaneously displayed.

VISUS · JiveX Enterprise PACS



**Highlights**

JiveX allows realizing holistic solutions without neglecting the special requirements of single specialty departments. The concept consists in supplying all important applications with a universal platform based on modern web technology at each workstation. This platform carries out the whole logistics from image acquisition to image and finding distribution with digital finding as well as radiogram finding and image archiving.

ADVANCED VISUALIZATION

Agfa · IMPAX Clinical Applications

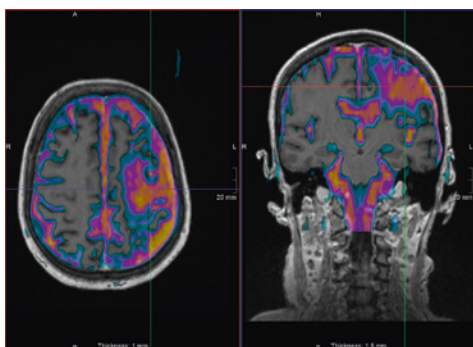

**Highlights**

- Agfa HealthCare delivers and supports a wide range of advanced visualization tools
- Advanced features for smart workflows
- Tight integration with PACS for fast creation and distribution of results
- Familiar interface and a high level of automation

Ebit · 3mensio CT – Structural Heart & Endovascular



**Highlights**

- Less invasive and more precise procedures with pre-op analysis
- 3mensio Structural Heart will let you plan aortic and mitral valve procedures and left atrial appendage closures
- The three software packages – LAA (Left Atrial Appendage) & TAVR (Transcatheter Aortic Valve Replacement), Aortic Root & TAVI (Transcatheter Aortic Valve Implantation), Mitral Valve & TMVI (Transcatheter Mitral Valve Implantation) – work with all major medical imaging formats of US/echo, XA and CTA and can access multiple data stores on the network, CD, DVD, USB or the internet



Ebit · CAAS IVUS OCT – Intravascular Software

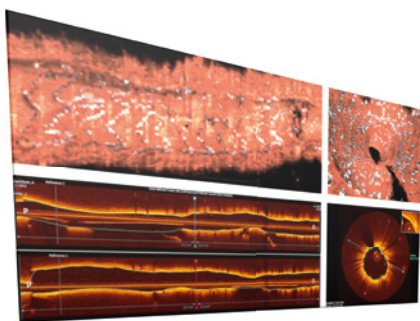

**Highlights**

- Pre-operative coronary assessment and post PCI follow-up with CAAS IntraVascular
- Analyze your IVUS and OCT data immediately after the pullback has finished or easily access the data at another convenient time. CAAS IntraVascular facilitates fast data transfer from your PACS or IVUS/OCT console. A dedicated workflow assistant guides you through the analysis. The software automatically fills the report with the available results and screenshots.

Ebit · CAAS MR – Magnetic Resonance Quantitative Analysis

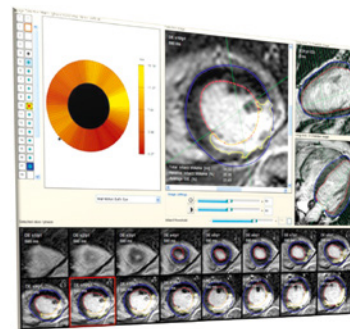

**Highlights**

- CAAS MR, Magnetic Resonance Quantitative Analysis for the newest intervention methods:
- Left and Right Ventricular Function Infarct Analysis and First Pass Perfusion Arterial Flow Quantification
- CAAS MRV enables cardiologists and radiologists to quickly quantify the performance of the heart CAAS MR Flow enables the user to perform analysis on Phase-Contrast MR images to quantify pulmonary and aortic blood flow and velocity.

# All medical information in one location



- ▶ *One standardized image and document viewer*
- ▶ *Inter-institutional communication via IHE-XDS*
- ▶ *Vendor Neutral Archive (VNA)*
- ▶ *HIS integration at all workstations and mobile devices*

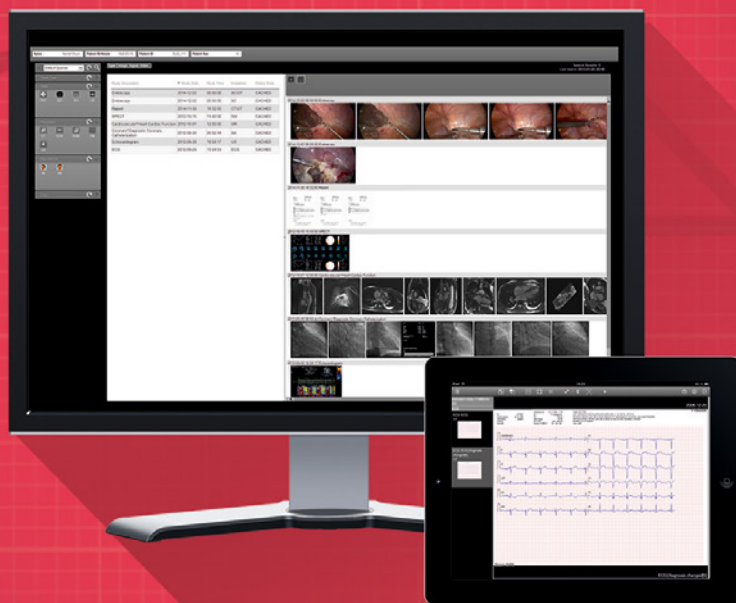

JiveX Medical Archive

www.visus.com

ADVANCED VISUALIZATION

Ebit · Suitestensa CVIS PACS



Highlights

- SUITESTENSA is the CVIS PACS imaging & information management software platform
- By encompassing all cardiology specialties into one single platform, it allows for achieving a better workflow from patient admission to exam execution, reporting, admin and distribution
- SUITESTENSA cardiology folder contains all exams performed (cath-lab, echo, ECG, EP) linkable to other diagnostic examinations

Ebit · SUITESTENSA RT – Radiotherapy Information System

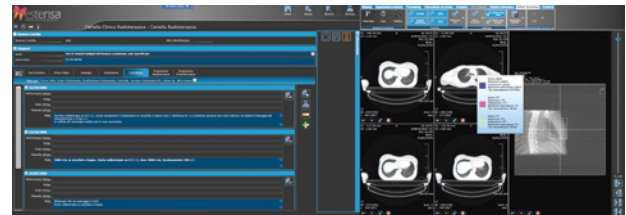

Highlights

- SUITESTENSA RT integrates data and images from all modalities and imaging departments and covers the needs of physicians and radiotherapists during the chemiotherapeutic and radiation treatment planning
- It includes the Electronic Patient Record folder, the Review module for advanced image visualization and reporting, and the PACS system for long-term archive and distribution of images related to the oncological patient
- Admission and treatment planning, outpatient visits, financial flows and accounting
- Radiotherapy PACS gathering all related images, and talking with all equipments: centering, treatment planning, simulator etc.

Ebit · CAAS XA – Quantitative X-Ray Angiography Software



Highlights

The CAAS platform (QCA, QVA, DSA, LVA, RVA, A-Valve, QRA Analysis) offers software packages for Quantitative X-ray Angiography Image Analysis allowing the performing of accurate and reproducible measurements of the dimensions of coronary arteries, peripheral blood vessels as well as left and right ventricles. It is the widest range of post-processing images solutions for cardiologists and radiologists, for optimized assistance during the intervention and in research settings.

FUJIFILM · SYNAPSE 3D



Highlights

The Synapse 3D Clinical Application Suite includes a comprehensive Base Toolset and the option to enhance your capabilities with an Advanced Radiology Toolset. Fujifilm innovations such as the award-winning automatic vessel segmentation and analysis algorithm, measurement tools, and exceptional masking using Fujifilm Image Intelligence help make Synapse 3D a vital part of your daily workflow.

IMAGE Information Systems · Image iQ-VIEW PRO 3D

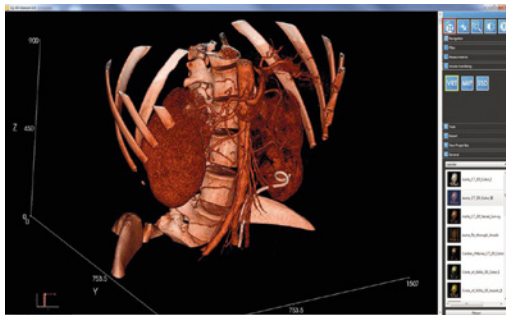

Highlights

- iQ-VIEW PRO 3D is an easy-to-use multimodality radiology workstation for any 2D- and 3D-readings including MPR, MIP and volume rendering.
- Integrated DICOM structured reporting module
- Supports virtually any image modality including MRI, CT, PET CT, CR, DR, US, mammography, SPECT images, fluoroscopy, tomosynthesis
- MPR, MIP, MiniIP, SSD, VRT
- RIS / HIS / EMR integrations available

IMAGE Information Systems · iQ-VIEW PRO 4D



Highlights

iQ-VIEW PRO 4D is an advanced multimodality and multiphase radiology reading solution for the post-processing of 2D, 3D and 4D medical images. It offers special applications for volume rendering, virtual endoscopy, bronchoscopy, vessel analysis and oncology RECIST follow up. There are tools for MPR, curved MPR, MIP and MiniIP, Volume rendering and multiphase Imaging with contrast uptake for breast MRI etc.

ITZ Medicom · ITZ Hyper.PACS – Reporting & Advanced Visualization

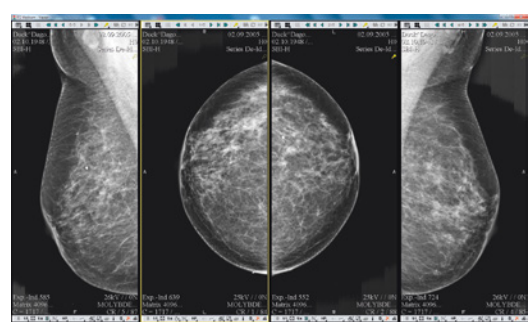

**Highlights**

- Universal solution for all purposes with special hanging protocols
- Free selection of postprocessing software for Radiology and Cardiology
- One surface for viewing, diagnosis and telemedicine
- Viewing-history, session-parking, MRT-space-time-presentation
- Real-time viewing, LVA, QCA and 3D-high-end-postprocessing
- Unlimited lists for demo, science and presentations

medigation · ImageVision

- Mammo MR Screening
- Calcium scoring
- CFA
- Coronaries / heart
- Lung
- EP planning
- Functional Imaging
- Stroke
- Vessel measurement
- Virtual colonoscopy

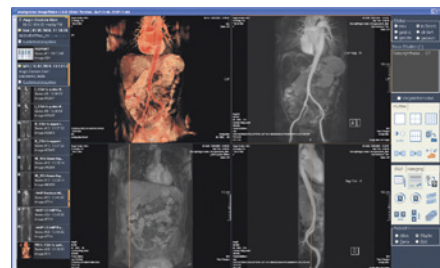

**Highlights**

- Easy to use, high performance examination and analysis system for radiological routines
- Access to all images (including previous images) within seconds
- Unique and hierarchical data compression without any loss
- Individually configurable hanging protocols
- Independent individual scaling of your interfaces

Siemens · syngo.via

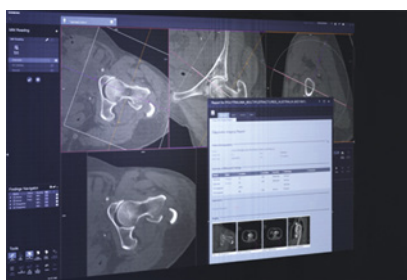

**Highlights**

- syngo.via is Siemens' software solution for 3D and advanced visualization.
- syngo.via provides a comprehensive suite of 3D reading applications for key clinical fields and imaging technologies.
  - Built on client-server architecture, you can access and process multimodality images in clinical networks.
  - It identifies human anatomy for reliable results and enables you to deliver them in one single report.

TeraRecon · iNtuition



**Highlights**

iNtuition, the winner of Best in KLAS 2014 for Advanced Visualization, offers the complete suites of vendor neutral imaging tools for volumetric interpretation of CT, MR and PET data via client-server and web-based cloud technologies. Its customizable Workflow Templates crates structured workflow with intelligent automation at each step which can be shared and distributed for fast diagnostics.

VISUS · JiveX Vessel Analysis



**Highlights**

Software for fast and convenient vessel segmentation, analysis and diagnosis. It is integrated with the JiveX Diagnostic workstation and allows all extra cardiac vessels to be defined and segmented selectively. Reports are stored back to the PACS and administrative systems. This tool can view and measure pathologies, e. g. stenosis or aneurysms, in curved MPR images.

Vital · VitreaWorkstation

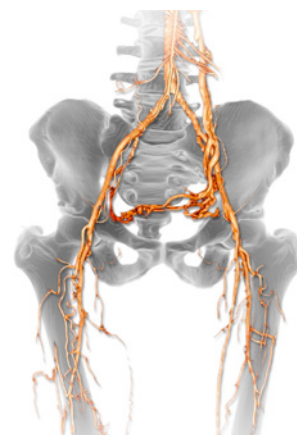

**Highlights**

VitreaWorkstation is an intuitive, multi-modality advanced visualization solution. It provides rich clinical tools for viewing human anatomy in 2D, 3D and 4D for efficient and effective patient care. It increases scanner productivity by extending workflow beyond the console and optimizing time and resources to produce clinical results.



ADVANCED VISUALIZATION

Vital · VitreaAdvanced



Highlights

VitreaAdvanced, Vital's advanced visualization solution, provides powerful 2D, 3D and 4D images for applications addressing cardiovascular, neurovascular and oncology disease states. VitreaAdvanced can be customized with Vital's clinical applications, and offers seamless integration and interoperability with PACS and EMR systems.

Vital · VitreaExtend

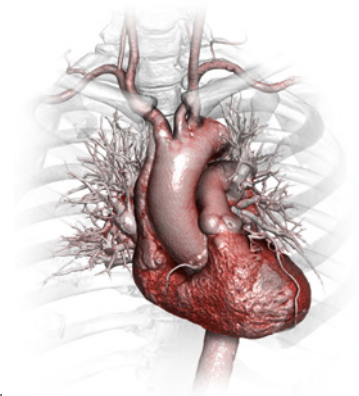

Highlights

VitreaExtend helps to improve patient care by providing quick access to the exams required by your clinical workflows. Easy to deploy and maintain, VitreaExtend delivers industry-leading clinical applications without adding significantly to the IT footprint. By supporting three concurrent advanced visualization sessions, VitreaExtend eliminates the need to maintain multiple workstations.

PORTAL SOLUTION

Canon · Healthcare IT Suite



Highlights

- Integrated solutions suite for radiology
- Cross-Enterprise Document Sharing (XDS) infrastructure reduces the duplication of unnecessary examinations, enabling patient treatment to start sooner.
- The medical software (RIS, PACS, XDS) increases efficiency for clerical and clinical workflows. The suite is fully compliant to industry standards and the Integrating Healthcare Enterprise (IHE) profiles.

CHILI · Telemedicine Record



Highlights

- The Telemedicine Record is a web-based platform for the exchange of multimedia documents (e.g. diagnoses, lab results, DICOM-compliant images).
- Capture, display and administration of patient data
- Upload and download of DICOM and other images
- Forwarding to referring doctors
- Suited for Inter-sector exchange of multimedia patient data
- Multicentre studies with DICOM images

FUJIFILM · SYNAPSE VNA

SYNAPSE

Highlights

- Multi-vendor environments are common place and Synapse VNA provides the platform to interface and integrate the data generated by these systems and provide actionable intelligence.
- Synapse VNA will enhance image management, streamline workflow, reduce costs and, most importantly, improve patient care.

medigation · PraxisPortal



Highlights

- To connect your referring practices
- Efficient and encoded transferral of image data
- Secure, user-defined access control
- Fast display of images and findings as PDF or SR
- No elaborate VPN necessary
- For PC/MAC: Intuitive, web-based tool, to be launched without any installation via any standard browser



mediation · webConnect

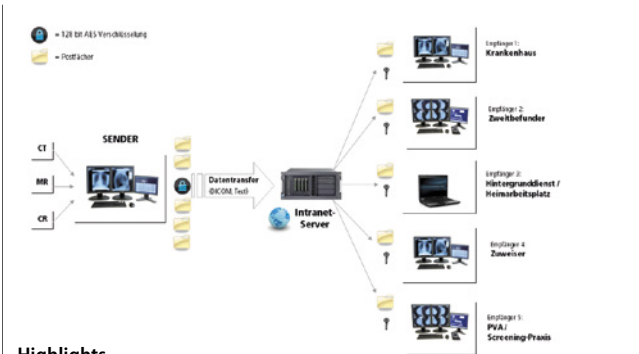

Highlights

- Uncomplicated exchange of image data via the internet
- Highly cost effective since only the actual transferred data is calculated
- Images and results can be called up within seconds due to intelligent data compression
- Total security by means of 256 bit AES encryption
- No VPN connection necessary

Siemens · syngo.share

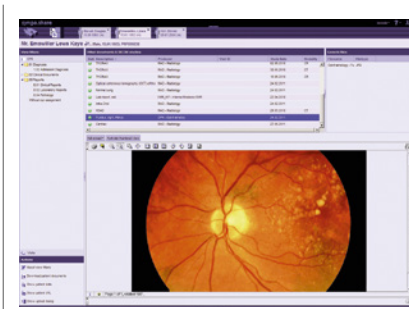

Highlights

- syngo.share is the smart VNA from Siemens. With its modular and scalable architecture, syngo.share can be deployed as departmental, enterprise-wide or regional solution.
- Universal data management and universal web viewer
- Dynamic data management for efficient usage of storage
- Multi-site data exchange (IHE XDS / XDS-I) and data management
- Supporting tumor boards, research, case collection, thin-slices handling, etc.

Siemens · teampay

Highlights

- teampay is a network that brings together healthcare professionals and patients in order to advance medicine and human health.
- Make prompt, well-informed decisions by connecting to current data, comparing benchmarks, and collaborating with healthcare professionals worldwide.
- Connect, compare, collaborate.

TeraRecon · iNtuition CLOUD

Highlights

- iNtuition CLOUD provides the company's award-winning flagship iNtuition solution for advanced visualization as an Internet-based service. Facilities can securely upload scans to the iNtuition CLOUD site, then log in via a browser from any Mac or PC to access the full suite of truly thin-client iNtuition tools.

Vital · VitreaView



Highlights

VitreaView is a universal viewer that directly addresses the needs of physicians who want uniform access through a simple intuitive user interface for all patient imaging. It offers secure integrated access to both DICOM and non-DICOM imaging through technologies such as EMR, EHR and HIE. VitreaView also enables access to images from disparate databases, providing one integrated universal viewer.

CAD

mediCAD – hectec · mediCAD mobile

Highlights

- mediCAD mobile gives you direct access to planning regardless time and location.
- Users of these devices save tremendous amounts of time. X-ray images, analyses, PACS images, planning files, and a wide variety of documents can be used directly at the point of care.

CAD

mediCAD – hectec · mediCAD hybrid 3D



**Highlights**

This new module opens up a whole new world for planning doctors. Now you can use CT or MRT images to plan in three dimensions. With fully automated recognition of all present vertebrae and segments, mediCAD 3D provides you with active support while performing a wide variety of measurements. Also available our 3D hip and trauma planning solution in 2015.

mediCAD – hectec · mediCAD classic 3.5

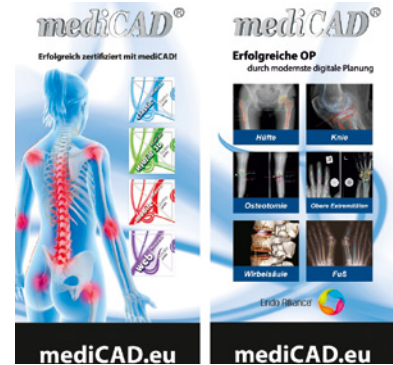

**Highlights**

mediCAD Classic is developed in collaboration with doctors for doctors. For you and your patients, this means:

- Made in Germany
- First and most common planning program on market worldwide
- Ready to use in 23 languages
- Time savings up to 85% compared to conventional planning processes
- Largest implant data base with more than 130 international implant manufacturers already integrated

mediCAD – hectec · mediCAD QueryClient



**Highlights**

mediQR and Query Client PACS connectivity for mediCAD works with the DICOM standard. For special adaptations to other digital systems, please contact us. With a range of partners we have already implemented a successful connection.

medigration · MammoView CAD-Option

- Brain
- Lung
- Mammo
- Cardio
- Liver
- Abdomen
- CT
- MRI
- CR / DR
- PET / CT

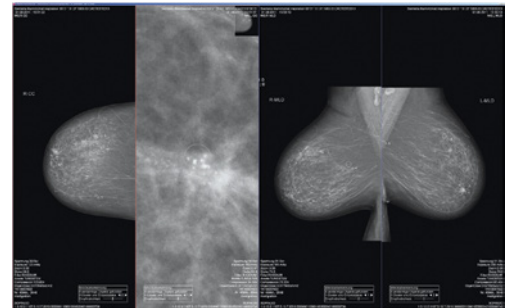

**Highlights**

- CAD microcalcifications detection and diagnosis support
- CAD calculation in the background without separate hardware
- Intuitive user interface for identification training
- Detected calcifications can be scaled up and viewed individually in sequence without additional expense

MAMMO WORKSTATION

Ebit · Suitestensa MG – Mammography Software System

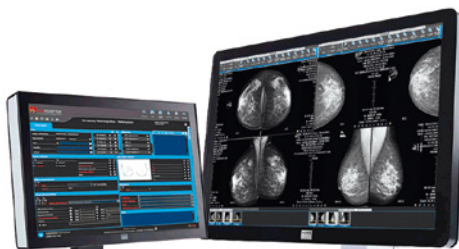

**Highlights**

- MG and PACS system for Breast Cancer Screening Programs in integrated HIS, RIS PACS environment
- Double-blind reading protocols, automatic arbitration, structured reporting performed directly on the images
- Image processing & CAD to automatically detect spots of calcifications within dense breast tissue
- DICOM IHE interoperability/integration protocols with CR, DR, MG, US, MR, XA, Multislice CT, Elastasonography, Tomosynthesis
- Multi-user, -department, -modality, -vendor

FUJIFILM · AXON Mammo



**Highlights**

- Specialist Mammography review workstation with Full Tomosynthesis Support
- Customizable user specific viewing protocols
- Dedicated keypad, exclusive to AXON
- Automatic storage of bookmarked images
- Support for IHE Mammo profiles and Multimodality DICOM
- Breast Line detection, quadrant view
- Local and long term image archival
- Auto Image Alignment and fit to screen

## Hologic · SecurView Diagnostic Workstations

**Highlights**

- Flexible, intuitive image review capabilities that are tailor made to the radiologist's specifications
- Interactively and intelligently through information-sharing – fast access to patient images
- Multimodality options allow all DICOM breast images from other imaging modalities such as ultrasound and MRI, improving workflow and efficiency
- Integrated CAD and breast density (Quantra) displays

## IMAGE Information Systems · iQ-VIEW PRO MAMMO TOMO

**Highlights**

iQ-VIEW PRO MAMMO TOMO is a unique mammography reading solution that incorporates the complete diagnostic imaging and staging process. There is no need to switch between workstations to perform mammography, ultrasound, CT, MRI and tomosynthesis readings anymore. It combines state-of-the-art features, such as vendor-independent hanging protocol sequences, automatic nipple height alignment, and support of high-resolution displays.

## medigation · MammoView



- Default display protocol
- Hi-Res displays or mixed setups
- Digital dictation integration
- Dedicated keypad
- WebClient

**Highlights**

- Extremely easy to use and manage
- Direct findings in the image
- CAD support (optional) and a second view area to examine US and MRT images
- Hanging protocols can be configured individually to automate your routine workflow
- Outstanding image quality (2,048 greyscale)

## Sectra · Sectra Breast Imaging PACS

**Highlights**

Sectra Breast Imaging PACS features true multi-modality capabilities and supports review of breast tomosynthesis images. Regardless of modality or vendor, all breast images are automatically aligned and displayed side-by-side in the same size and dimension. CAD is an integrated part of the reading workstation and the ergonomic key pad offers fast and easy access to the most commonly used tools.

## Siemens · syngo.Breast Care

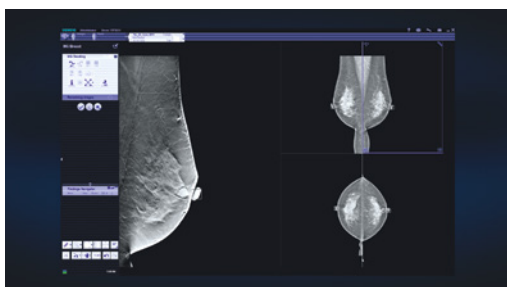
**Highlights**

- Advanced solution for state-of-the-art mammography and tomosynthesis reading
- Customization of workflows according to personal preferences
- Flexible hardware configuration
- Mammography and multi-modality 3D/4D reading – in a single workplace
- Unique Link-it algorithm automatically displays corresponding areas of special regions of interest in any other 2D or 3D view

## VISUS · JiveX Diagnostic Mammo / Tomosynthesis

**Highlights**

The independent reporting software JiveX Diagnostic Mammo was developed specifically for curative mammography and mammography screening. The highly specialized hanging and reading protocols meet the most challenging requirements for smooth work processes. As an option, the system disposes of the JiveX Mammo Report Manager which is a fully integrated module for reporting.



MOBILE RIS/PACS VIEWER

Agfa · Enterprise Imaging XERO Viewer



**Highlights**

- Offers fast, on-demand image and report access, regardless of location or origin
- Provides secure, private content access
- Delivers seamless EMR integration, irrespective of application
- Leverages existing technology investment
- Expands traditional reach of hospital clinical services

CHILI · Mobile



**Highlights**

- Mobile image viewer
- Teleradiology
- PACS administration
- Easy integration into HIS/RIS/PACS
- Can be integrated into any EPR
- Independent of operating system (iOS, Android, ...)
- Device independent (Apple, Google, ...)
- Works without internet shop
- No app – but HTML5!
- Works with any PACS

FUJIFILM · SYNAPSE Mobility



**Highlights**

- Synapse Mobility, Fujifilm's versatile solution for on-the-go access to all your patient reports and images from your iPad, iPhone or Android smart phone.
- Synapse Mobility delivers many of the powerful, flexible advanced visualization tools you are used to working with at a traditional Synapse workstation: 2D toolkit, 3D toolkit

GE Healthcare · Centricity Radiology Mobile Access



**Highlights**

Centricity Radiology Mobile Access provides enhanced efficiency for clinicians throughout – and beyond – your facility with the AccessNOW application for qualified Apple iOS and Android mobile devices. Access to images and reports from Centricity PACS and Centricity Clinical Archive, 2D, 3D and MIP / MPR.

IMAGE Information Systems · Image iQ-MOBILITY



**Highlights**

- World's first portable medical display offering DICOM calibrated grayscale diagnostics to perform diagnostic multimodality readings from any location
- Powerful portable laptop with a high-end 17"

IMAGE Information Systems · Image iQ-WEB2GO



**Highlights**

- Instant access to any radiology image without running an installer
- Excellent solution for clinical reference for referring physicians
- Useful for remote and subspecialty consultation
- Image display in full-screen mode
- iQ-WEB2GO is a portable viewer of radiology images on iOS, Symbian or Android based mobile, handheld devices including the iPhone, iPad, Samsung Galaxy SII or Samsung Galaxy Tab.



IMAGE Information Systems · Image iQ-4VIEW



**Highlights**

iQ-4VIEW is a ground-breaking diagnostic multimodality zero-footprint viewer, suitable for virtually all browsers and operating systems. It runs on almost any device and requires no installation on the client. iQ-4VIEW allows reading, viewing or reviewing any kind of images, structured reports and Encapsulated PDFs.

ITZ Medicom · ITZ Hyper.PACS Mobile Solutions

**Highlights**

- ITZ Hyper.PACS supports all mobile devices and tablet-PC
- The solution is scalable to your needs and budgets
- Also bidirectional transmission possible
- Save by encryption and/or anonymized transmission
- Receive your images wherever you are with high image quality
- Different functionalities from viewing up to diagnosis
- Administration from any location

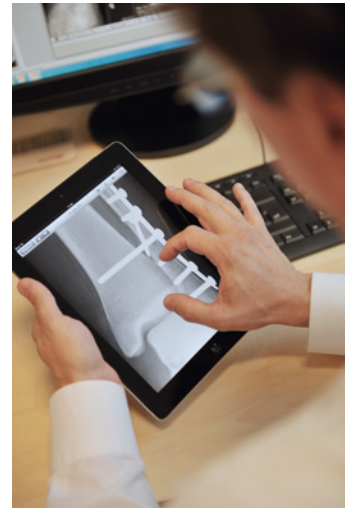

medigration · PraxisPortal App



**Highlights**

- To connect your referring practices
- Efficient and encoded transferral of image data
- Secure, user-defined access control
- Fast display of images and findings as PDF or SR
- No elaborate VPN necessary
- For iPad / iPhone: Installation and updates easily via AppStore

Sectra · Sectra LiteView

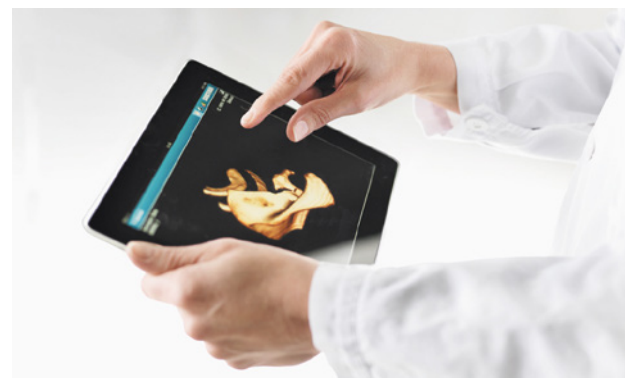

**Highlights**

Sectra LiteView, allows for mobile access to images and reports on iPads as well as on common web viewers, further enhancing communication with referring physicians. It also helps reduce lead times, and supports decision-making and patient interaction.

TeraRecon · iNteract+



**Highlights**

TeraRecon's iNteract+ delivers a powerful universal and extensible viewer throughout the health system. Its morphable viewer capabilities display the right information, with the right images and the right tools, at the right place and in real-time depending on each physician's needs. It also features a seamless, secure, and complete image and clinical content sharing solutions.

VISUS · JiveX Mobile



**Highlights**

JiveX Mobile gives the clinical staff more flexibility and facilitates communication in every-day clinical. Both tablet PCs and smartphones are excellently suited as a mobile desk if – and only if – the required data are quickly available, consistent throughout the hospital network and comply with the strict data privacy rules in healthcare.

ACCESSORIES / COMPLEMENTARY SYSTEMS

Agfa · IMPAX Business Intelligence



**Highlights**

- Management decisions driven by insight
- Optimizes work processes and quality of care
- Improves and accelerates decision-making
- Identifies trends and cost-saving opportunities
- Creates market understanding that enables comparative benchmarking
- Delivers operational confidence and better patient satisfaction

Canon · Information Quality System (IQS)



**Highlights**

- A vendor neutral quality solution for imaging departments
- Supports the teaching programs and enables compliance for quality management, by finding out why images had to be retaken
- Receives images from any DICOM
- Evaluate rejected images
- Keep track of the dosages administered
- Generate self-assessments from the approved images as well
- Valuable statistics to manage quality KPI's

FUJIFILM · SYNAPSE ERm

SYNAPSE

**Highlights**

- Communication tool for acute stroke and emergency cases
- Fujifilm offers an expanding portfolio to enable the display of medical images.
- SYNAPSE ERm is a mobile application for emergency treatment.
- It supports smooth communication for emergency cases like acute stroke by linking the clinical images and data on mobile devices.

i-SOLUTIONS · RadCentre Mammography & MRI Prostate

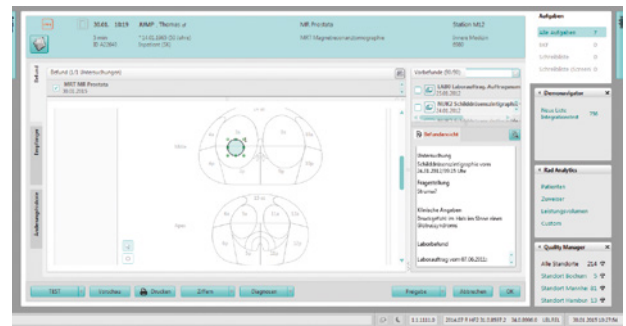

**Highlights**

- Based on guidelines RadCentre offers Mammography and MRI Prostate workplace profiles for a structured and graphic generation of reports that set new standards in operating comfort and security.
- Integrated guidelines for an increase in report quality and comparability
- More quality assurance and liability for referring physicians

i-SOLUTIONS · RadCentre Quality Manager

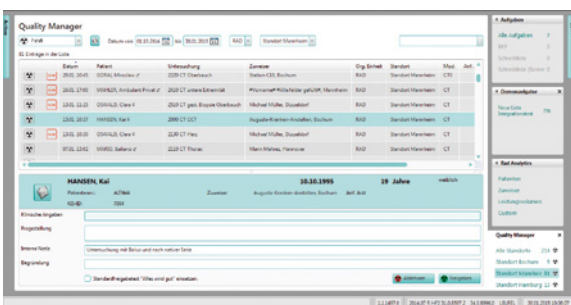

**Highlights**

- RadCentre Quality Manager supports the justification and documentation process. It increases quality assurance, patient safety and efficiency of examinations and offers quick overview of information for doctors to initiate the justification.
- Integrated justification process
  - Overview of non-validated examinations
  - Easy planning of examinations and specific information for technologists

Sectra · Sectra Business Analytics Suite



**Highlights**

- Sectra's business analytics offering comprises Sectra DataWarehouse and Sectra BizTrack analytics applications. These help streamline the radiology workflow by providing tools for monitoring the production and performance of PACS and RIS, including analyses of Key Performance Indicators.

# Mammography

Tomosynthesis  
Digital Mammography  
Film-Screen Mammography  
Biopsy Tables  
Accessories /  
Complementary Systems

**FUJIFILM**



**HOLOGIC®**



**GCTechnology GmbH**



**Planmed**



**SIEMENS**

**VARiAN**  
medical systems



## TOMOSYNTHESIS

### IMS · GIOTTO CLASS – Tomosynthesis

<b>Power</b>	8 kW
<b>Resolution</b>	a-Se 24 x 30 cm
<b>Pixel size</b>	85 µm (without binning)



#### Highlights

- New DBT system allows superior clinical results with low dose
- DBT scan angle of 30° with 11 exposures
- “Step & Shoot” tube motion combined with 85 µm pixel size for the best visualization of microcalcifications
- Fast Iterative Reconstruction Software dedicated for DBT
- Multifunctional system: DBT, SYNTHETIC VIEW, FFDM, TOMO-Guided or Stereo Biopsy with the patient in a PRONE or UPRIGHT, CEDM

### IMS · Giotto CLASS FLEXITABLE

<b>Detector</b>	Amorphous Selenium latest generation, 24 x 30 cm
<b>Pixel size</b>	85 µm (without binning)
<b>Technology</b>	Biopsy table for TOMO-Guided or Stereo BIOPSY with the patient in a PRONE position



#### Highlights

- The FLEXITABLE in combination with Giotto CLASS allows the operator to perform Tomo-Guided or Stereo biopsy with the patient in prone position, operating with the same detector used in the DBT clinical investigation. It guarantees to proceed with the same visualization of lesions like in DBT.
- Prone position provides 360° access to the breast with lateral, cranial caudal and inclined approach

### IMS · Giotto Tomo

<b>Power</b>	8 kW
<b>Detector</b>	Amorphous Selenium, 24 x 30 cm
<b>Pixel size</b>	85 µm

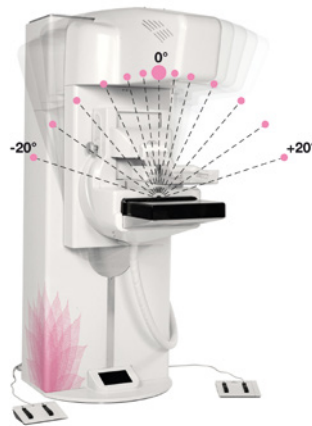

#### Highlights

- 2nd generation DBT allows to see clearly small and subtle microcalcifications; high spatial resolution (6 lp/mm) with the “Step & Shoot” motion and 85µm native pixel size
- Giotto Tomo uses variable doses to optimize parameters and enables, in the COMBO mode, a extrapolated mammographic view as a CC or MLO central projection in the same compression
- Only 13 exposures with a scanning angle of 40°

**Buy & sell used equipment on**



[www.dotmed.com](http://www.dotmed.com)

**Over 400,000 listings**  
**Over 20,000 daily visitors**

## DIGITAL MAMMOGRAPHY

### DMS / APELEM · Serenys DR Bym

<b>Power</b>	5 kW
<b>Detector</b>	FPD 18 x 24 cm or 24 x 30 cm
<b>Pixel size</b>	85 µm
<b>kV Range</b>	20 – 40 kV



#### Highlights

- The Serenys DR Bym, with the added advantage of an isocentric C-arm including stereotactic biopsy
- The isocentric C-arm can be fully motorized and permits all breast projections without moving the patient and without adjusting the height of the C-arm, making exams faster and more comfortable
- The device is also available in analogic version

### FUJIFILM · Amulet Innovality

<b>Power</b>	7 kW
<b>Detector</b>	a-Se direct conversion with HCP (Hexagonal Close Pattern)
<b>Pixel size</b>	50 micron



#### Highlights

- Choice of 2 tomosynthesis angles depending on the clinical need
- Intelligent exposure control with automatic implant detection
- Ultimate patient comfort with new adaptive compression paddle
- 50 micron image at extremely low radiation dose
- High DQE and high MTF
- HCP detector design
- Stereotactic biopsy examinations with lateral approach optional
- Tomosynthesis and S-View optional



**FUJIFILM · Amulet S**

<b>Power</b>	3.5 kW
<b>Detector</b>	a-Se direct optical switching
<b>Pixel size</b>	50 micron



**Highlights**

- Ultimate patient comfort with adaptive compression paddle
- Optimised for user & patient ergonomics
- 50 micron image at extremely low radiation dose
- High DQE and high MTF
- Direct optical switching technology
- Auto-positioning
- Single-touch function
- Compatible with digital mammography CAD
- Specially designed AWS (Acquisition Workstation)

**GE Healthcare · Senographe Care**

<b>kV Range</b>	22 – 35 kV
<b>Detector</b>	a-Silizium, 24x31 cm
<b>Pixel size</b>	100 µm



**Highlights**

- Combination of iodinated contrast medium and digital mammography with a-Silizium detector
- Reliable, affordable system
- Optimized image quality and dose efficiency
- Dual track tube Mo/Rh-Stereo
- Option available

- Super IQ for dense breast
- The landmark in breast care
- Image quality. Clearly Excellent

**GE Healthcare · Senographe Crystal**



**Highlights**

- Easy to transition to full-field mammography
- Small footprint
- Simplified installation
- Automated functions – intuitive interface – compact ergonomic design
- Excellent 2D image quality – Single-chip mammography CMOS detector

**GE Healthcare · Senographe Essential**

<b>kV Range</b>	20 – 49 kV
<b>Detector</b>	a-Silizium, 24x31 cm
<b>Pixel size</b>	100 µm



**Highlights**

- High patient throughput
- Dual track tube Mo/Rh
- Automatic Optimization of Parameters (AOP)
- Ergonomic paddles that shape to the breast
- Stereo-option available
- SenoClaire – Digital Breast Tomosynthesis option available

- SenoBright – Contrast Enhanced Spectral Mammography (CESM) option available – to localize potential lesions when initial screening results prove inconclusive

**Hologic · Selenia Digital Breast Imaging Solutions**

<b>Resolution</b>	70 µm
<b>Detector</b>	Amorphous Selenium, 24 x 29 cm



**Highlights**

- Selenia digital mammography system is designed to deliver exceptional sharp, digital images, with excellent contrast and consistency
- Robust and flexible for any clinical setting, including mobile environments and full service practices that wish to perform both screening and diagnostic mammography examinations, the Selenia system is designed to support your workflow preferences

**Hologic · Selenia Dimensions 2D/3D Mammography System**

<b>Power</b>	n/a
<b>Detector</b>	Amorphous Selenium, 24 x 29 cm
<b>Pixel size</b>	70 µm



**Highlights**

- Selenia Dimensions 3D breast tomosynthesis technology allows doctors to see lesions with a clarity never before possible. Studies show that masses, distortions and asymmetric densities are better visualized and that recall rates are reduced with Hologic's breast tomosynthesis technology.
- Seamless, instantaneous transition between imaging modes: 2D and 3D acquired in the same compression

## DIGITAL MAMMOGRAPHY

### IMS · Giotto Image 3DL

<b>Power</b>	8 kW
<b>Detector</b>	a-Se, 24x30 cm
<b>Pixel size</b>	85 µm



#### Highlights

- 3D-movements of the circular arm
- Isocentric rotation, prearranged for stereotactic biopsy and prone biopsy using the same detector
- Very low x-ray dose
- High DQE and high MTF
- Amorphous selenium detector: available in 24x30 cm

### IMS · Giotto Mammo-bed

<b>Detector</b>	a-Se, 24x30 cm – same of mammography
<b>Resolution</b>	85 µm



#### Highlights

- Prone biopsy table using the same mammography unit detector, guarantee that the lesion visualized during the mammography exam will also be visible during biopsy. Reducing the risk to lose hidden lesions.
- The system provides 360° access to the breast with no repositioning of patient. Possible to choose the best possible approach to the breast: frontal, frontal inclined and lateral.

### Planmed · Clarity 2D

<b>Power</b>	23 – 35 kV
<b>Detector</b>	Amorphous Silicon, 24x30 cm
<b>Pixel size</b>	83 µm

#### Highlights

- Intelligent dual touch screen user interface that adapts to different imaging modes
- Image post processing that can be tailored to radiologist preferences
- Side access for optimal patient positioning and user ergonomics
- Integrated MaxView breast positioning system for maximal tissue visibility
- Upgradeable to Planmed Clarity 3D digital breast tomosynthesis



### Planmed · Nuance Excel

<b>Power</b>	20 – 35 kV
<b>Detector</b>	a-Se, 23.9x30.5 cm
<b>Pixel size</b>	85 µm

#### Highlights

- Low dose FFDM unit with fully automatic Flex-AEC with tissue type recognition
- Acquisition workstation (AWS) with 3 MP TFT monitor and optional Nuance Acquire Station with motorized height adjustment
- Integrated MaxView breast positioning system
- Side access for optimal patient positioning and ergonomics
- Optional: geometric magnification kit; stereotactics with Nuance DigiGuide



### Siemens · Mammomat Fusion

<b>Technology</b>	W / Rh, CsI
<b>Detector</b>	23 x 30 cm
<b>Resolution</b>	83 µm

#### Highlights

- New mammography system with proven premium features for everyday screening and diagnostics
- 2nd generation CsI detector technology for higher spatial resolution at low dose
- Proven Tungsten tube technology for dose reduction up to 50%
- Personalized OpDose and Adaptive AEC Algorithm for individual dose calculation
- Flexible OpView for customized image impression
- Single-touch positioning and more time saving features for a faster workflow



### Siemens · Mammomat Inspiration Prime Edition

<b>Technology</b>	W / Rh, a-Se
<b>Detector</b>	24x30 cm
<b>Resolution</b>	85 µm

#### Highlights

- Offers all features and functions of the Mammomat Inspiration plus in addition:
- PRIME Technology: World's first anti-scatter solution in mammography
- Combines gridless acquisition and Progressive Reconstruction
- Up to 30 % less dose with uncompromised image quality



**Siemens · Mammomat Inspiration**

<b>Technology</b>	Mo/Mo, Mo/Rh, W/Rh, a-Se
<b>Detector</b>	24x30 cm
<b>Resolution</b>	85 µm



**Highlights**

- Platform for multiple applications: Screening, diagnostics, stereotactic biopsy and tomosynthesis
- Direct-to digital a-Se detector
- Personalized OpDose and AEC Algorithm for individual dose reduction
- Flexible OpView with 5 different flavors for customized image impression
- Single-touch positioning, and more time saving features enhanced workflow
- Unique MoodLight helping women relax

**Siemens · True 3D Breast Tomosynthesis**

<b>Technology</b>	W/Rh, a-Se
<b>Detector</b>	24x30 cm
<b>Resolution</b>	85 µm



**Highlights**

- True 3D Breast Tomosynthesis for increased depth resolution and contrast as well as improved capabilities to diagnose
- 3D-imaging with the industry's widest angle of 50° (+25° to -25°) and 25 projections
- HD Volume Reconstruction for high definition results
- True 3D Breast Tomosynthesis is available on Mammomat Inspiration and Mammomat Inspiration Prime

**VILLA SISTEMI MEDICAL · Melody III d**

<b>Power</b>	5 kW
<b>Detector</b>	a-Selenium, 24x30 cm
<b>Pixel size</b>	85 µm



**Highlights**

- High performance integrated X-ray generator with wide kV range (20 – 35 kV) and fine adjustment (0.5 kV step)
- AEC with dual modality: PRE in function of effective Breast Density and FAST in function of compressed breast thickness
- Version with isocentric C-arm dedicated for biopsy procedures
- Stereotactic biopsy device with computerized parameters calculation and needle positioning

**Wandong · Phoenix Full-field Digital Mammography – DM-1**

<b>Detector</b>	a-Se 300x240 mm / 85 x 85 µm
<b>kV Range</b>	20~ 40 kV
<b>Power</b>	4.8 kW
<b>Anode</b>	300 kHU 0.1 mm/0.3 mm



**Highlights**

- Programmable positioning greatly speeds up your work flow
- By using unique breast auto examine technology system will automatically adjust the exposure parameters
- Minimal radiation dose realized with no loss of image quality
- Intelligent compression program and ergonomic designs provide patients with more comfort

**FILM-SCREEN MAMMOGRAPHY**

**Planmed · Nuance Classic**

<b>Power</b>	20 – 35 kV
<b>Anode</b>	Mo
<b>Filter</b>	Mo/Rh



**Highlights**

- High-end analog mammography unit with Flex-AEC
- Field upgradeable to full field digital mammography
- Side access patient positioning
- Optional MaxView breast positioning system
- Stereotactics system available as an add-on
- CR interface available

**Planmed · Sophie Classic**

<b>Power</b>	20 – 35 kV
<b>Anode</b>	Mo
<b>Filter</b>	Mo/Rh



**Highlights**

- Versatile mid-tier film unit with multiple options
- Optional Flex-AEC with tissue type recognition
- Optional MaxView or TwinComp compression system
- Optional magnification and stereotactics
- Optional CR interface

## FILM-SCREEN MAMMOGRAPHY

### Planned · Sophie Classic S

<b>Power</b>	20 – 35 kV
<b>Anode</b>	Mo
<b>Filter</b>	Mo/Rh



#### Highlights

- Entry level film unit
- Optional magnification
- Optional stereotactics
- Optional CR interface

### Siemens · Mammomat Select

<b>Filter</b>	Mo / Mo or Mo / Rh
<b>Object Table</b>	(Bucky) 18 x 24 cm or 24 x 30 cm
<b>Interface</b>	Film ID camera or CR reader



#### Highlights

- Designed for easy and fast operation:
- New analog mammography system enhanced with smart features
  - Full access to the exposure controls from a single compact console
  - Breast thickness and Automatic Exposure Control (AEC) measurements for achieving optimal image quality at the right dose

### VILLA SISTEMI MEDICALI · Melody III

<b>Power</b>	5 kW
<b>Anode</b>	Molybdenum
<b>Filter</b>	Mo/Rh



#### Highlights

- High performance integrated X-ray generator with wide kV range (20 – 35 kV) and fine adjustment (0.5 kV step)
- AEC with selection of exposure parameters in function of effective breast density
- C-arm with  $\pm 180^\circ$  rotation
- Version with isocentric C-arm dedicated for biopsy procedures
- Available with 18x24 / 24x30 cm bucky or special potter accepting both cassettes

# RAD BOOK 2015

Please visit us at

[www.healthcare-in-europe.com](http://www.healthcare-in-europe.com)

## BIOPSY TABLES

### Hologic · Affirm Breast Biopsy Guidance System



#### Highlights

- The Affirm breast biopsy guidance system is designed to meet the biopsy challenges and needs of today and paves the way for future advances in interventional procedures with its tomosynthesis biopsy option.
- For Stereotactic and Tomosynthesis Interventional Procedures
  - Designed for the Hologic Selenia Dimensions digital mammography system
  - 10° angled biopsy approach for unobstructed view

### Hologic · MultiCare Platinum System



#### Highlights

- The MultiCare Platinum breast biopsy prone table offer exceptional image quality, pinpoint accuracy and precise, efficient operation using leading-edge targeting and guidance technology.
- Intuitive Cartesian Coordinates help to ensure both accurate targeting
  - Digital Spot Mammography (DSM) offers a wide array of tools for effective targeting and image enhancement



## Hologic · StereoLoc II Breast Biopsy Guidance System



### Highlights

Hologic StereoLoc II upright systems offers exceptional image quality, and efficient operation using leading-edge targeting and guidance technology.

- Compatible with most biopsy devices
- Designed for the Selenia Performance digital mammography system
- Intuitive Cartesian Coordinates help to ensure both accurate targeting
- Digital Spot Mammography (DSM) offers a wide array of tools for effective targeting and image enhancement

## IMS · Giotto CLASS FLEXITABLE

<b>Pixel size</b>	85 µm (without binning)
<b>Detector</b>	Amorphous Selenium latest generation, 24x30 cm
<b>Technology</b>	Biopsy table for TOMO-Guided or Stereo BIOPSY with the patient in a PRONE position



### Highlights

- The FLEXITABLE in combination with Giotto CLASS allows the operator to perform Tomo-Guided or Stereo biopsy with the patient in prone position, operating with the same detector used in the DBT clinical investigation. It guarantees to proceed with the same visualization of lesions like in DBT.
- Prone position provides 360° access to the breast with lateral, cranial caudal and inclined approach

## IMS · Giotto Mammo-bed

<b>Detector</b>	a-Se, 24x30 cm – same of mammography
<b>Resolution</b>	85 µm



### Highlights

- Prone biopsy table using the same mammography unit detector, guarantee that the lesion visualized during the mammography exam will also be visible during biopsy. Reducing the risk to lose hidden lesions.
- The system provides 360° access to the breast with no repositioning of patient. Possible to choose the best possible approach to the breast: frontal, frontal inclined and lateral.

# Medicor

Medizintechnik  
auf höchstem  
Niveau

*Die Grundlage für eine  
gesunde Zukunft*

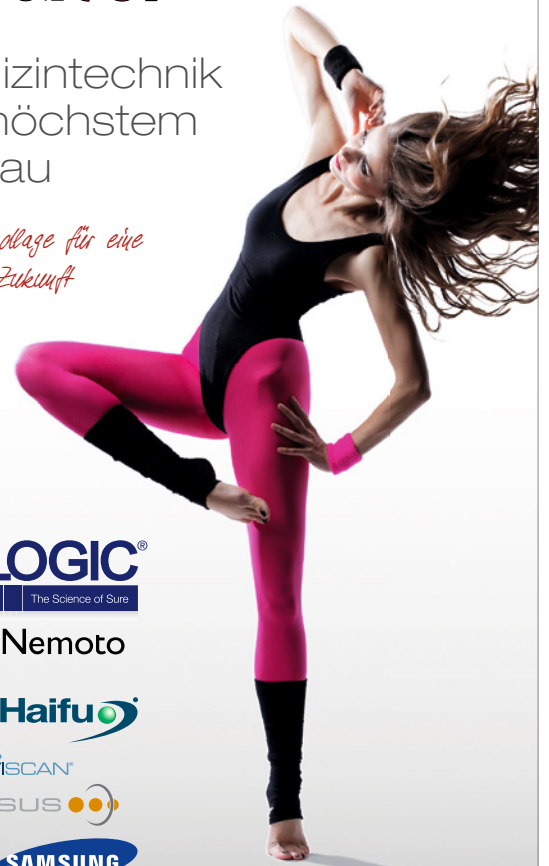

**HOLOGIC®**  
The Science of Sure

**Nemoto**

**AMICA**  
Approved for MRM & MRM Active

**Haifu®**

**CMR NAVISCAN™**

**VISUS**

**WOM**

**SAMSUNG**

Weltweite Partnerschaften  
garantieren diesen Anspruch

- 3D-Tomosynthese, digitale Vollfeld-Mammographie (FFDM) sowie Tomosynthese-gesteuerte Brust-Biopsie
- Interventionelle Mammographie und mobile Assessmenteinheit sowie Vakuumbiopsiesysteme für Ultraschall, Stereotaxie und MRT
- Bodycomposition- und Knochendichtemessplätze
- Mini C-Bogen Systeme
- Workstations und CAD-Systeme für Mammdiagnostik, Tomosynthese und MRT
- Kontrastmittelinjektoren für MRT, CT und DSA
- Tumor-Therapie mit hochfokussiertem Ultraschall und Mikrowellenablation
- Mobile brustspezifische Positronen-Emissions-Tomographie (PEM)
- PACS, Befundung, Bildmanagement und Standortvernetzung
- Lymphknotendetektor
- Digitale Röntgen- und Ultraschallgeräte

Besuchen Sie uns unter:  
[www.medicor.biz](http://www.medicor.biz)



**MMS Medicor Medical Supplies GmbH**  
Heinrich-Hertz-Straße 6 · 50170 Kerpen  
Telefon +49 2273 9808-0 · Fax +49 2273 9808-99  
zentrale@medicor.de



**Medicor Medical Supplies GmbH**  
Weyringergasse 6 · 1040 Wien  
Telefon +43 1 504 6671-0 · Fax +43 1 504 6671-99  
zentrale@medicor.at



**Medicor Medical Supplies GmbH**  
Gewerbstrasse 10 · 6330 Cham  
Telefon +41 41 7410700 · Fax +41 41 7494088  
zentrale@medicor.ch

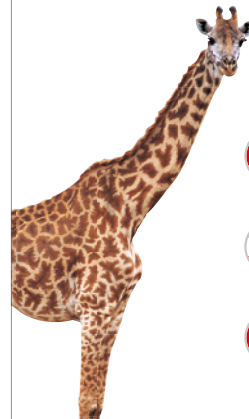

## ACCESSORIES / COMPLEMENTARY SYSTEMS

### GCTechnology · CIRS Phantoms

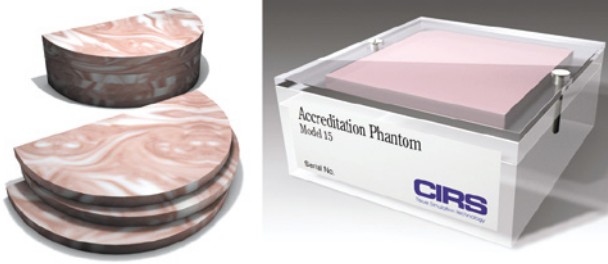

#### Highlights

- Mammography BR3D Phantom (Tomosynthesis and Breast CT)
- Multi-Modality Breast Biopsy and Sonographic Trainer (CT, US, MR)
- Mammographic accreditation phantom (evaluation of small structures detectability)
- Stereotactic needle breast phantom
- Mammography test tools
- Mammography Phototimer Consistency testing slabs
- Digital mammography phantoms
- Mammoview markers

### Hologic · ATEC Breast Biopsy and Excision System

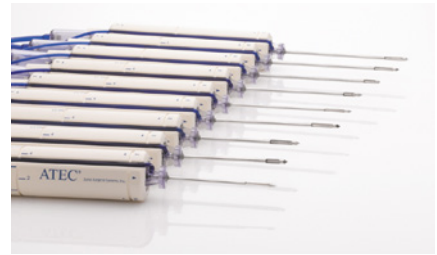

#### Highlights

- The ATEC breast biopsy and excising system is designed to provide clinicians with easier and more effective access to lesions with fewer needle insertions.
- Tissue acquisition occurs every 4.5 seconds
  - Easily delivers local anesthetic without interruption
  - Fully closed system and fully disposable device reduce contamination risk
  - Multiple needle options to address a wide spectrum of patients
  - One user-friendly console for every modality
  - No software to program or operate console
  - One minute set-up and clean-up

### Hologic · Eviva Breast Biopsy Device



#### Highlights

- The Eviva biopsy device is designed to deliver a fast, comfortable and accurate procedure. The innovative design of the device is optimized to reach the broadest spectrum of patients using both prone and upright systems.
- Quiet, remote firing and with integrated pain management
  - Average tissue acquisition time of 1 minute
  - Control and consistency
  - Direct control of sampling with tactile thumb wheel
  - Combination of saline lavage and constant aspiration helps ensure a core with every cycle High-quality cores ensured with saline lavage and constant aspiration
  - End deploy site marking solution

### Hologic · ImageChecker CAD

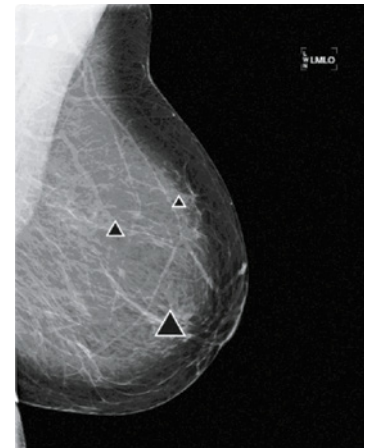

#### Highlights

- ImageChecker CAD software can process images from most direct capture digital mammography detectors and displays them on a range of workstation environments. The display of digital CAD marks depends upon the viewing solution chosen. Whichever display you choose, basic RightOn CAD marks will appear on all displays.

### Hologic · Lower Dose Tomo (C-View Software Option)

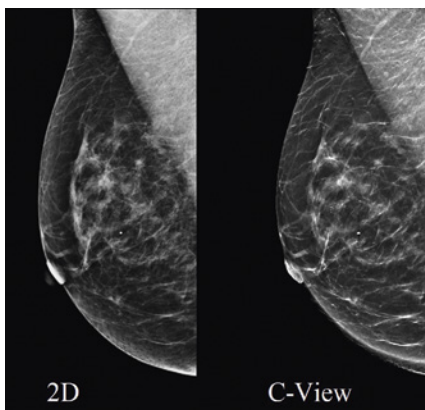

#### Highlights

- C-View software generates 2D images from Hologic's 3D tomosynthesis data without the need for a 2D exposure.
- C-View software is designed to lower patient radiation dose, making the 3D mammography dose comparable to a 2D only exam while maintaining all the clinical benefits and superior image quality of 3D.

### Hologic · Quantra Breast Density Assessment Software

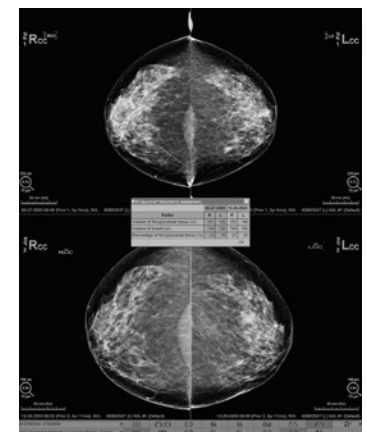

#### Highlights

- Quantra volumetric breast density assessment software is a powerful breakthrough technology that estimates a woman's breast density by using details of the x-ray imaging chain to quantify fibroglandular tissue. Quantra aggregates volumetric measurements from each view in a study into a simple, concise assessment for each breast.

Hologic · Trident Specimen Radiography System

**Highlights**

The Trident system allows for instant verification of biopsy samples, resulting in reduced procedure time and improved workflow.

- User-friendly operator interface
- Superb image quality for rapid verification
- One-touch x-ray control with AEC for fast image acquisition
- Large, 12 x 14 cm active imaging area
- Enhanced Visualization tool with five levels of image optimization for added sharpness and lesion conspicuity
- Fully integrated, maneuverable and ergonomic workstation



**RAD BOOK 2015**

Please visit us at

[www.healthcare-in-europe.com](http://www.healthcare-in-europe.com)

I.A.E. · XK1016T

**Highlights**

- Rotating anode mammography X-ray tube, with special bi-angled target, for optimal performances with all techniques
- Two separate focal tracks, small focus on 10° and large focus on 16°, optimal resolution performances
- Reduced thermal stress on the bearings improves tube life duration
- Severe tests during conditioning assure best performances
- Compact light weight structure



I.A.E. · C340

**Highlights**

- Water cooled mammography tube unit for beam scanning mammography equipments, high patients throughput screening applications
- Brass body lead free X-ray shielding internal pump for oil circulation improves oil to casing thermal exchange
- Water cooled jacket avoids remote oil circulation
- Compact lightweight structure
- 800 W continuous dissipation for high energy techniques, high patients throughput

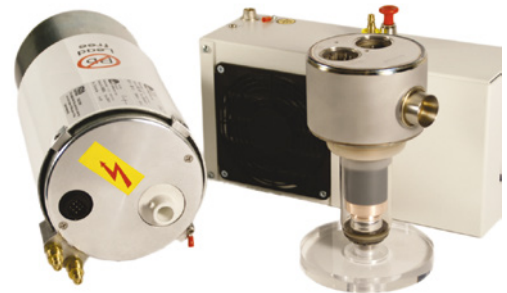

QUART · Q-Vision Biopsy QA system

**Highlights**

- The QUART Q-Vision combines an IQ phantom and DAP meter into a complete QA system. This enables comprehensive but very time efficient QA/QC testing in stereotactic biopsy.
- Image quality analyses can be directly correlated with dose reference values, thereby achieving a very high level of quality control and equipment safety. The system is optimised for small fields-of-view in stereotactic biopsy.



Varian · B-121 Mammography Housing

**Highlights**

- Air Cooled Mammography Housing
- Fits with a standard size (three inch) X-ray tube insert
- Digital and tomography applications
- 300 Watts of continuous dissipation with fans
- Increased dissipation rates over standard mammography housings
- 20% increase without fans
- 200% increase with fans
- Two Shroud configurations
- Quiet D/C fans; optional A/C fans



# R / F Film-Screen

Bucky  
Fluoroscopy  
X-Ray Mobile  
Accessories /  
Complementary Systems



GCTechnology GmbH



GMM



SIEMENS



TOSHIBA



SECTRA





**BUCKY**

**GMM · OPERA RT20 – RAD and TOMO compact unit**

**Power** From 32 kW up to 80 kW  
**Table** Adjustable height table  
**Design** Floor mounted

**Highlights**

- Compact radiographic units ensuring application versatility and operational efficiency.
- X-ray tube remarkable displacements for quick and easy execution of any examination and oblique incidences also on stretchers.
- Total safety and comfort for the patient and enhanced diagnostic results in examinations of the spine, thorax, legs, etc.
- Utmost user-friendliness also in combination with wall stands.



**PROTEC · BUCKY series**

**Power** Various  
**Table** Integration to table/wall stand/U-arm

**Highlights**

- Outstanding compatibility with X-ray tables, wall stands and U-arm systems of various brands
- High cost effectiveness due to continuation of use of existing grids and AEC chambers
- All established detector types are supported
- Suitable for cassettes/detectors of different dimensions
- Perfectly prepared for simple realisation when upgrading an existing analogue system to a fully digital DR



**PROTEC · PRS 500 F/E**

**Power** 40 / 50 / 65 / 80 kW  
**Table** Fixed or adjustable height, floating carbon fibre table top

**Highlights**

- Compact bucky system for minimal space requirements
- PROVARIO HF generator integrated into table (40 – 80 kW)
- APR and AEC
- Automatic coupling device to center tube and bucky
- Including wall bucky stand; stitching as optional solution
- Table with floating carbon fiber table top
- Individual system configuration from analogue to fully digital solution
- Adjustable height with PRS 500 E



**Shimadzu · RADspeed series**

**Power** 50 / 65 / 80 kW  
**Table** Motorised height adjustable

**Highlights**

- Floor-mounted or ceiling-mounted X-ray tube assembly
- Parameter setting next to the patient
- Up to 400 application programs
- Auto-positioning function
- Automatic tracking functions
- Flat panel detector upgradability



**Shimadzu · RADspeed fit**

**Power** 32 kW / 56 kW  
**Table** Floating type  
**kV Range** 40 – 150 kV

**Highlights**

- Ultra compact X-ray unit
- Heavy load capacity of floating X-ray table
- Up to 432 application programs
- Flexible positioning of X-ray tube support
- Upgradeability to a fully-fledged digital system

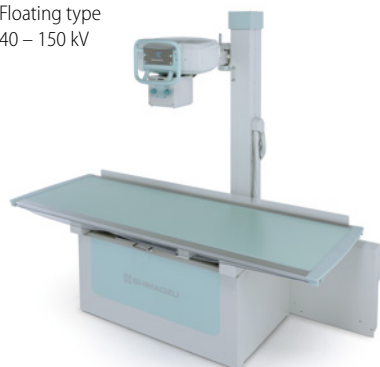

Please visit us at  
[www.healthcare-in-europe.com](http://www.healthcare-in-europe.com)

## R/F FILM-SCREEN

### BUCKY

#### Siemens · Multix Fusion

**Power** 55 / 65 / 80 kW  
**Table** Free-floating, height adjustable, up to 300 kg



#### Highlights

- Fits your needs.  
 Fits your budget.
- Key components adapted from Ysio like table, tube, bucky wall stand and many more
  - Automation – Fast positioning with advanced tube tracking and comfortable maneuvering
  - Small space requirements – fits your room and budget
  - Prepared for the future – digitize your system whenever you prefer

#### STEPHANIX · RAD series

**System concept** Cost efficient, multipurpose  
**Technology** Upgradable to DR  
**Design** Compact and reliable solution  
**Power** Up to 80 kW

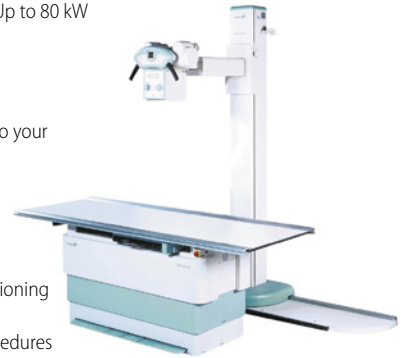

#### Highlights

- Designed for customising to your application and budgetary considerations
- Multi-functional and digital-ready
- Ergonomically shaped with floating table for easy positioning
- Small space requirement
- Wide range of general procedures
- Intuitive touch screen generator with 864 APR available
- Fixed or variable height table
- Floor or ceiling tubestand
- Tomography

#### Toshiba · RADREX

**Power** 50 kW or 80 kW  
**Table** Motorized height adjustable with floating tabletop



#### Highlights

Toshiba recommends Radrex compact radiographic systems for general-purpose radiography, being highly accurate and efficient. It is possible to expand the original system to meet the particular clinical requirements of the user. When the system is combined with a portable FPD (35x43 cm) and digital processor, a wide range of applications can be performed.

#### VILLA SISTEMI MEDICALI · Moviplan

**Power** 32 / 40 / 50 / 65 / 80 kW  
**Table** Fixed or elevating tabletop  
**Cassette size** From 13 x 18 cm to 35 x 43 cm

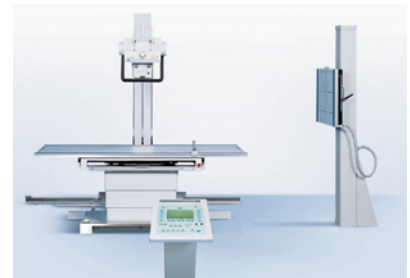

#### Highlights

- Modular bucky system for general radiographic applications, musculoskeletal diagnostic room or emergency ward
- Several configuration options: table available with motorized lift, floor-mounted or ceiling suspended tubestand
- Optional tomographic functionalities

### FLUOROSCOPY

#### DMS / APELEM · Optima Conventional

**Power** 50 / 65 / 80 kW  
**Design** Remote-controlled conventional system  
**Detector** Conventional cassette, CR or DR RAD with image intensifier



#### Highlights

- The Optima is the latest table designed and developed by DMS APELEM. This solution is designed to be effective and adapt to any type of budget.
- Patient coverage 195 cm with 2-way and >270 cm with 4-way table top
  - +90° / -30° motorized tilting table, this table performs all types of R/F examinations
  - SID up to 180 cm
  - Fully motorized tube rotation
  - Innovative tilt / shift movement allowing 79 cm height

#### GMM · OPERA T – Multifunctional remote-controlled table

**Power** 50 kW up to 80 kW  
**Design** Universal remote-controlled table  
**Image system** I.I. and FPD



#### Highlights

- Wide range of advanced, cost-effective R/F remote-controlled tables.
- Six different configurations available to suit the actual operators' needs.
- 90 / 30° or 90 / 90° tilting movement; 210 cm or 240 cm tabletop lengths; 150 or 180 cm FFD.
- Different combinations with SFD-I.I. / TV chain or DR or RF flat panel detector.
- Wide versatility of application enhanced by a comprehensive series of accessories.

**Shimadzu · Flexavision series**

<b>Power</b>	50/80 kW
<b>II format</b>	12 or 9
<b>Image system</b>	Digital or analog



**Highlights**

- 90/30 Digital or analog local R/F table
- Flexible configuration
- High reliability
- Turnable footrest
- Meets all requirements for routine R/F exams

**Siemens · Luminos RF Classic**

<b>Design</b>	Remote-controlled R/F system
<b>Technology</b>	1 k x 1 k matrix
<b>II format</b>	23 or 33 cm

**Highlights**

- Complete patient coverage with 8-way tabletop travel and large receptor movements
- Single-handed cassette handling: automatic loading, centering, format sensing and collimation
- Intuitive and fast operation with innovative control console
- Dose-saving fluoroscopy with SUPERVISION (option)
- Bucky wall stand (option)
- Excellent price-performance ratio

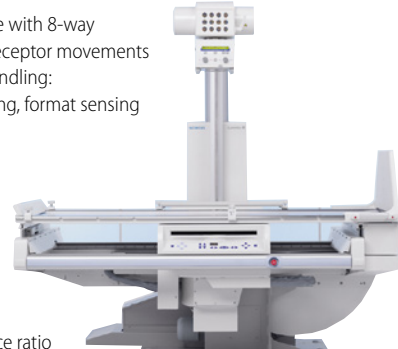

**Siemens · Luminos Select**

<b>Design</b>	Digital remote-controlled R/F system
<b>Technology</b>	1 k x 1 k matrix
<b>II format</b>	33 cm

**Highlights**

Luminos Select – don't compromise, be select.

- Platform concept – select to match your budget
- Common Siemens user interface for ease of use
- Imaging system from our high-end products
- Table with excellent patient access from all sides
- This system provides economical access to select Luminos fluoroscopy system technologies backed by Siemens' market leadership



**STEPHANIX · EVIDENCE**

<b>System concept</b>	Versatile and robust remote controlled table
<b>Technology</b>	Upgradable to digital with image Intensifier and Flat Panel Detector
<b>Design</b>	Compact and reliable solution
<b>Power</b>	Up to 80 kW

**Highlights**

- Complete patient coverage
- Smart 8 ways tabletop travel for easy and comfortable patient transfer
- Column angulation  $\pm 40^\circ$  on the whole table's length
- Tomography
- Fixed or variable height
- Video camera for patient positioning to optimize dose reduction



**Buy & sell used equipment on**



**www.dotmed.com**

**Over 400,000 listings**  
**Over 20,000 daily visitors**

**Toshiba · Plessart EX 8**

<b>Power</b>	80 kW
<b>II format</b>	12
<b>Image system</b>	1 k x 1 k CCD

**Highlights**

The Plessart VIVO is a digital remote control R/F system comprising a R/F diagnostic table with an over-table X-ray tube configuration, an X-ray high-voltage generator, and a digital imaging system. This system is intended for use as a general-purpose system for abdominal angiography, general abdominal radiography, general skeletal radiography, support of endoscopic procedures, etc.



FLUOROSCOPY

Toshiba · Plessart VIVO

Power 50 kW



Highlights

- Toshiba Plessart VIVO is a remote control R/F system comprising an R/F diagnostic table with an over-table X-ray tube configuration, an X-ray high-voltage generator, and a digital imaging system.
- This system is intended for use as a general-purpose system for abdominal angiography, general abdominal radiography, general skeletal radiography, support of endoscopic procedures, etc.

Buy & sell used equipment on



www.dotmed.com

Over 400,000 listings  
Over 20,000 daily visitors

VILLA SISTEMI MEDICALI · Apollo

Power 50 / 65 / 80 kW  
II format 9" / 12" / 16"  
Image system Analog or digital with I.I.



Highlights

- Premium remote controlled system for full clinical coverage in R/F applications
- Full patient coverage by moving only the tube-receptor assembly, without patient repositioning
- SFD with line and cross divisions
- Up to 180 cm Source to Image Distance
- Oblique projections at table edges and bar-less tomography
- Automatic grid parking

VILLA SISTEMI MEDICALI · Apollo EZ

Power 50 / 65 / 80 kW  
II format 9" / 12"  
Image system Analog or digital with I.I.



Highlights

- Compact and cost-effective system for all the needs of radiographic and R/F imaging
- Available with 2-way or 4-way flat tabletop, plastic or carbon-fiber
- SFD with either line or cross divisions
- Variable Source to Image Distance: up to 180 cm
- Oblique projections at table edges and bar-less tomography
- Automatic grid parking

VILLA SISTEMI MEDICALI · Apollo Open

Power 50 / 65 / 80 kW  
II format 9" / 12" / 16"  
Image system Analog or digital with I.I.



Highlights

- Premium remote controlled system with OPEN tabletop, allowing 4-side access to the patient
- Full patient coverage by moving only the tube-receptor assembly, without patient repositioning
- SFD with line and cross divisions
- Up to 180 cm Source to Image Distance
- Oblique projections at table edges and bar-less tomography
- Standard carbon fiber tabletop
- Automatic grid parking

VILLA SISTEMI MEDICALI · Vision

Power 50 / 65 / 80 kW  
II format 9" 12"  
Image system Analog or digital with I.I.



Highlights

- Available with 2-way or 4-way tabletop
- Powerful SFD with line/cross divisions
- Can mount either 9" or 12" Image Intensifiers
- Ready for connection with DIVA digital acquisition system



## Wandong · HF81 Series

<b>Power</b>	80 kW
<b>II format</b>	12 inches
<b>Image system</b>	CCD 1 kx 1 k

**Highlights**

- High frequency  
80 kW / 200 kHz generator
- Remote tilting table  $-25^{\circ}$  /  $-45^{\circ}$
- SID adjustable 100 / 150 cm
- 600 kHU X-ray tube Assembly
- 9" or 12" three fields I.I.
- 1 kx 1 k high resolution with 30 fps image acquisition rate
- InvaRay digital imaging platform, DICOM 3.0 fully support
- Comprehensive digital imaging processing

## Wandong · HF51 Series

<b>Power</b>	50 kW
<b>II format</b>	12 inches
<b>Image system</b>	CCD 1 kx 1 k

**Highlights**

- High frequency  
50 kW generator
- Remote tilting table  
 $90^{\circ}$  /  $-25^{\circ}$
- Variable SID 100 / 150 cm
- 9" or 12" three fields I.I.
- 1 kx 1 k digital RF imaging/TV system
- InvaRay digital imaging platform  
DICOM 3.0 fully support
- Two-table two-tube configuration is available

## X-RAY MOBILE

## DMS / APELEM · Rafale EV30

<b>Power</b>	30 kW
<b>kV Range</b>	40 – 125 kV with 1 kV steps
<b>mAs Range</b>	0.5 to 200 mAs in 25 steps

**Highlights**

- Useful for bedridden patients in geriatrics or gastroenterology but also for short x-ray exposures of children
- Designed to be used in the smallest departments and to be moved in narrow corridors
- The design offers excellent visibility when moving the unit
- Can be upgraded to DR with the EZ2GO (wifi FPD + tablet)

# RAD BOOK 2015

Please visit us at  
[www.healthcare-in-europe.com](http://www.healthcare-in-europe.com)

## GE Healthcare · Brivo XR285amx

<b>Power</b>	15 / 30 kW
<b>kV Range</b>	40 – 150
<b>mAs Range</b>	0.2 – 630

**Highlights**

- More power in a compact design
- 24 / 7 availability, no boot-up required
- Automatic charging
- Improved storage

## Shimadzu · MobileArt eco

<b>Power</b>	12.5 kW
<b>kV Range</b>	40 – 125
<b>mAs Range</b>	0.32 – 100 (200)

**Highlights**

- Telescopic arm
- Easy positioning
- Wide coverage
- Compact design

X-RAY MOBILE

**Shimadzu · MobileArt Evolution EFX**

<b>Power</b>	32 kW
<b>kV Range</b>	40 – 133
<b>mAs Range</b>	0.32 – 320



**Highlights**

- Superb image quality
- Easy handling
- User-friendly operation
- Sophisticated radiographic functions
- Low noise motorized System
- Energy saving collimator with a bright irradiation field through LEDs
- DR ready: Flat panel detector upgradability

**Shimadzu · MobileArt Evolution EFX**

<b>Power</b>	12.5 kW
<b>kV Range</b>	40 – 125
<b>mAs Range</b>	0.32 – 320



**Highlights**

- Superb image quality
- Easy handling
- User-friendly operation
- Sophisticated radiographic functions
- Energy saving collimator with a bright irradiation field through LEDs
- Low noise motorized system

**Buy & sell used equipment on**



**www.dotmed.com**

*Over 400,000 listings*  
*Over 20,000 daily visitors*

<b>Siemens ·</b>	<b>Multimobil 2.5</b>	<b>Multimobil 10</b>
<b>Power</b>	2.5 kW	10 kW
<b>kV Range</b>	40 – 100	40 – 125



**Highlights**

The economical solution in mobile X-ray imaging.

- Short exposure times and a constant imaging power provide a high image quality
- Easy handling and maneuverability based on a lightweight and compact design
- Entry level analog mobile X-ray system

<b>Siemens ·</b>	<b>MOBILETT XP</b>	<b>MOBILETT XP Hybrid</b>	<b>MOBILETT XP Eco</b>
<b>Power</b>	30 kW, 450 mA (max.)	30 kW, 450 mA (max.)	20 kW, 400 mA (max.)
<b>kV Range</b>	40 – 133	40 – 133	40 – 125



**Highlights**

Remarkable user comfort in advanced mobile X-ray imaging.

- Excellent image quality due to extremely short exposure times as low as 1 ms and a powerful 30 kW generator
- Easy mobility and effortless positioning based on a lightweight and compact design, and an articulated swivel arm
- Remarkable user comfort, supported by self-explaining functionality, to ideally support the daily routine
- MOBILETT XP Hybrid can be operated from both battery and mains power and offers the convenience of motor assisted traveling
- Advanced analog mobile X-ray system

**Siemens · POLYMOBIL Plus**

<b>Power</b>	16 kW (optional 20 kW)
<b>kV Range</b>	40 – 125

**Highlights**

Simplicity and reliability in mobile X-ray imaging.

- High image quality due to high power output and a minimum exposure time < 4 ms
- Easy handling and maneuverability based on a lightweight and compact system design
- High reliability
- Powerful entry level analog mobile X-ray system

**STEPHANIX · MOVIX Series E+**

<b>Power</b>	From 16 to 32 kW
<b>Technology</b>	Capacitor assisted high frequency generator
<b>kV Range</b>	Up to 150 kVp
<b>mAs Range</b>	Up to 500 mAs

**Highlights**

- Cost effective solution
- Compactness ensures easy handling
- User-friendly interface with 492 customizable anatomical programmes
- Wide range of procedures
- X-ray tube with rotating anode
- Thin dual focal spots
- High heat capacity
- Short exposure time

**VILLA SISTEMI MEDICALI · Visitor T4**

<b>Motorized</b>	No
<b>Power</b>	4 kW
<b>kV Range</b>	40 – 110
<b>mAs Range</b>	0.2 – 250

**Highlights**

- Cost-effective mobile unit granting compactness and ease of use
- Suitable for most examinations performed in plaster rooms, emergency and health screenings contexts
- Compact and lightweight design for easy handling

# RAD BOOK 2015

Please visit us at

[www.healthcare-in-europe.com](http://www.healthcare-in-europe.com)

**VILLA SISTEMI MEDICALI · Visitor T30C**

<b>Motorized</b>	No
<b>Power</b>	32 kW
<b>kV Range</b>	40 – 125
<b>mAs Range</b>	0.1 – 220

**Highlights**

- Mobile unit designed for emergency context as well as orthopedics, pediatric or surgery departments
- Compact and lightweight design for a high maneuverability of the unit
- High performance generator and double focal spot (0.8/ 1.3 mm) tubehead
- APR anatomic mode
- User friendly control panel

**Wandong · PX100-CLK**

<b>kV Range</b>	40 ~ 100 kV
<b>mAs Range</b>	0.4 ~ 98 mAs
<b>Power</b>	1.6 kW

**Highlights**

PX series mobile X-ray system can be used mainly for radiography in the operation room, emergency ward, orthopedics and surgical treatment. Apply high frequency conversion technology, greatly improve image quality, shorten exposure time, and reduce the harmful radiation to human body. High frequency generator, Ergonomics designed, Microcomputer-control, easy to operate, maintain and move.

ACCESSORIES / COMPLEMENTARY SYSTEMS

GCTechnology · CIRS Phantoms



**Highlights**

- Pediatric anthropomorphic training phantom
- ATOMMax dental and diagnostic head phantom
- Radiography fluoroscopy QA phantom
- 3dimensional torso phantom
- Test tools

PROTEC · PROGNOST XP-series

**Power Table**

Line or battery  
Fixed or adjustable height (optional), carbon fiber table top



**Highlights**

- Mobile patient table to position the patient directly above the corresponding image receptor
- For digital DR detectors or with bucky tray integrated
- Fixed table height or elevating with floating carbon fibre table top
- Elevating versions with line connection or battery powered

Please visit us at  
[www.healthcare-in-europe.com](http://www.healthcare-in-europe.com)

QUART · Anthropomorphic Phantoms

**Highlights**

- Our German-made anthropomorphic x-ray phantoms allow repeated x-ray imaging of specific body regions. They are used in x-ray trainings or for specific equipment tests under life-like conditions.
- The phantoms comprise of real human bones embedded in tissue-equivalent material.



Available Phantom Versions

- Full Body
- Head
- Hand/ Arm
- Hip/ Spine
- Foot/ Leg
- Special Training Phantoms

Sectra · Sectra DoseTrack

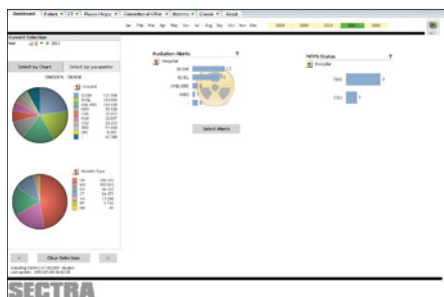

**Highlights**

- Sectra DoseTrack is a web-based dose monitoring solution that allows you to monitor patient radiation doses and ensure that they are kept as low as reasonably achievable (ALARA). Sectra DoseTrack automatically collects, stores and monitors data from all connected modalities saving valuable time and facilitating analysis.
- Sectra DoseTrack supports both the IHE Radiation Exposure Monitoring profile and the DICOM MPPS standard, enabling the connection of almost any modality to gain a complete dose monitoring solution.

Sectra · Sectra OneScreen



**Highlights**

- Sectra OneScreen is a cost-effective online solution to identify patients in the risk group for osteoporosis. The service is especially convenient in combination with mammography. With a single, standard X-ray image of the hand the women's bone health (Bone Mineral Density, BMD) is estimated, using the patented DXR (Digital X-ray Radiogrammetry) technology.



# healthcare-in-europe.com

Trends & innovations in healthcare.



25 YEARS  
of European  
healthcare  
communication:  
print & online.



Stay  
tuned  
on all  
channels.

Online Portal | Newspaper | Product Guides | Newsletter

published by  
**EUROPEAN HOSPITAL**

European Hospital Verlags GmbH | Theodor-Althoff-Straße 45 | 45133 Essen  
follow us on | visit us on   
[www.healthcare-in-europe.com](http://www.healthcare-in-europe.com)

# R/F Digital

Conventional  
Digital  
DR Retrofit  
Mobile DR  
Flatpanel Fluoro  
Accessories /  
Complementary Systems

**AGFA**   
HealthCare

**DOTmed**<sup>®</sup>

**DUNLEE**  
A Division of Philips Healthcare

**DMS**  
DMS Group  
**ΔPELEM**  
DMS Group

**Canon**

 **GE Healthcare**

**FUJIFILM**

**HITACHI**  
Inspire the Next

  
**GMM**

**medigration**  
The Digital Company  
ein Unternehmen der bender gruppe

  
**KONICA MINOLTA**

**HOLOGIC**<sup>®</sup>

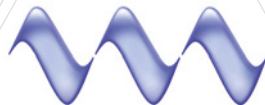
  
**MECALL**

**iae** 

**Primax**  
international

  
**PROTEC**  
TEAM | SPIRIT | ABILITY

 **SHIMADZU**  
Excellence in Science

**SIEMENS**

**stephani**   
RADIOLOGICAL SOLUTIONS

**Swissray** 

**TOSHIBA**

 **WDM**

**VARiAN**  
medical systems

**AGY**

**T**  
TECHNIX

 **VILLA**  
SISTEMI MEDICALI

## CONVENTIONAL

## Agfa · CR 10-X

<b>Slots</b>	1
<b>Resolution</b>	20 bits/pixel
<b>Cassette size</b>	35x43 cm

**Highlights**

- Affordable CR solution that makes no compromises in image quality
- For a convenient and fast workflow
- Robust, yet easy to install and maintain
- Fits in small spaces and is suited for mobile applications
- Networking capabilities deliver seamless integration
- Capacity: 34 plates/hour

## Agfa · CR 15-X

<b>Power</b>	Autoranging external power supply (24V output)
<b>Size</b>	580 x 700 x 471 mm (w x d x h)
<b>Slots</b>	Single slot cassette feed

**Highlights**

- Affordable for a broad range of applications
- Convenient and fast workflow, with usercontrollable speed and resolution
- Robust yet easy to install and maintain
- Fits in small spaces and is suited for mobile applications
- Highly versatile, compact CR 15-X offers an ideal solution for decentralised hospital environments, clinics and private practices.

## Agfa · CR 12-X

<b>Slots</b>	1
<b>Resolution</b>	max. 200 µm/pixel
<b>Cassette size</b>	35x43 cm

**Highlights**

- Affordable CR system offering high image quality
- Customer-chosen optimal workflow
- Robust, yet easy to install and maintain
- Suited for mobile applications
- Networking capabilities deliver seamless integration

## Agfa · CR 30-Xm

<b>Slots</b>	1
<b>Resolution</b>	10 pixels/mm, 20 pixels/mm for mammography
<b>Cassette size</b>	From 15x30 cm to 35x43 cm, incl. mammography

**Highlights**

- Tabletop digitizer
- Broad range of applications: mammography, general radiography, orthopaedics, chiropractic, dental and FLFS
- No quality compromises
- Horizontal cassette insertion
- Low total cost of ownership
- Mobile use
- Capacity: up to 82 plates/h

## Agfa · DX-M

<b>Slots</b>	1 – 5 cassettes: drop and go buffer
<b>Resolution</b>	6.7 – 20 pixels/mm
<b>Cassette size</b>	From 15x30 cm to 35x43 cm, incl. mammography

**Highlights**

- Next-generation CR digitizer
- NIP and PIP detectors for general radiography and mammography
- Superb image quality and potential for dose reduction
- Five cassette drop-and-go buffer
- Small footprint
- Capacity: approx. 83 plates per hour (35x43 cm cassette)
- MUSICA Image Processing

## FUJIFILM · FCR XG 5000

<b>Slots</b>	4
<b>Resolution</b>	5 – 10 pixel/mm
<b>Capacity</b>	165 imaging plates (IPs)/h

**Highlights**

- Worldwide more than 90,000 FUJIFILM CR systems installed
- Universal applicable
- IHE certified
- Wide dynamic range
- Optimized workflow





Sonialvision G4  
multifunctional R/F system

# Deep insights for extended applications

In the year of Shimadzu's 140th anniversary, new systems continue the company's tradition in diagnostic imaging providing innovative technologies and industry firsts.

## Vascular interventions from head to toe: Trinias angiographic system series

The Trinias angiography series are multipurpose systems for cardiovascular and angiographic procedures. The units are available in a floor- and ceiling-mounted version or as a biplane system.

Trinias is equipped with a 30x30 cm FPD supporting a wide range of vascular interventions from head to toe, from cerebral, cardiac, and abdominal blood vessels to peripheral blood vessels in the upper and lower extremities or, with a 20x20 cm FPD, supporting specialist cardiovascular interventions.

The Trinias series apply the SCORE, SMART and SMILE philosophy that sets Shimadzu apart:

- SCORE imaging technology ensures powerful support for advanced interventions while reducing patient dose and increasing image quality
- SMART design allows significantly enhanced operability with fast response time
- SMILE concept is primarily about comprehensive X-ray dose management and comfort of patients and operators.

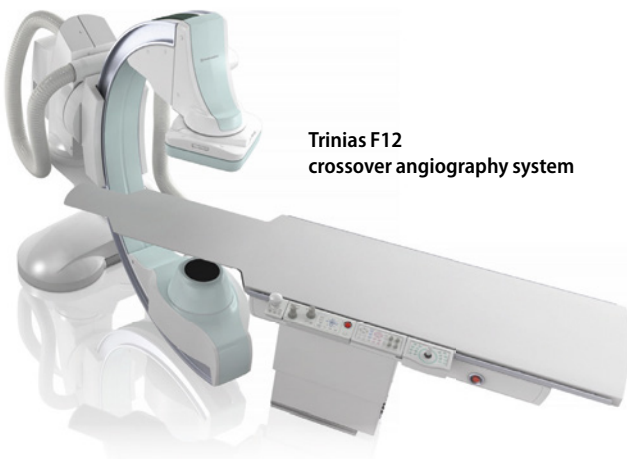

Trinias F12  
crossover angiography system



### Best-in-class: Sonialvision G4 multifunctional R/F system

The Sonialvision G4 high performance R/F table provides numerous best-in-class features significantly increasing its functionality and operability.

The Sonialvision G4 unites the widest possible range of examinations with inter-departmental hospital capability. It is equipped with the largest available FPD at 43x43 cm and Shimadzu's next generation digital imaging platform. Together with the large longitudinal stroke of Sonialvision G4, the FPD provides an extensive imaging area. In combination with an additional ceiling-mounted telescopic arm, a Bucky wall stand, and a second mobile FPD, the system easily extends into a sophisticated multifunctional R/F room.

In addition, advanced "SUREngine" technology (Shimadzu Ultimate Real-time Enhancement Engine) contributes to creating excellent image quality. It enables the natural enhancement of the entire image for clearer revelation of all examination areas including small, faint targets.

### RADspeed *fit* (DR ready): best-in-class features for general radiography

The new RADspeed *fit* (DR ready) provides easy operability and extensive functionality for reducing exposure levels while supporting a wide range of general radio-



The new RADspeed *fit* (DR ready) ultra-compact X-ray unit

graphic applications, such as chest, abdomen or extremities, and including emergency examinations. Furthermore, it can be combined with a digital or analog image processing system, making it ideal as an entry level digital radiography (DR) system equipped with a digital X-ray detector (FPD) or even complementing an existing CR or DR environment.

New product features include

- highest image quality in its class
- highest weight capacity in its class
- smooth examination process
- an option for reducing the X-ray dose.

### Mobile X-ray applications: evolving technology with outstanding flexibility

The new X-ray unit MobileDaRt Evolution EFX can be moved to any location where radiography is required, enabling on-site examinations and image verification. Capitalizing on the merits of efficiency and high throughput, this digital mobile X-ray system, which is equippable with differently sized wireless flat panel detectors (FPD), broadens its applications from clinical rounds in hospitals to critical care and applications at disaster sites, as well as operating rooms and neonatal intensive care units (NICU).

The choice of three detectors (42x43 cm, 35x43 cm and 27x35 cm) provides superior flexibility for users. They combine high sensitivity with the lowest possible dose of radiation and provide sharp high-quality images in areas such as radiology, emergency rooms, traumatology, orthopaedics, paediatrics, or on the ward.

New features improve safety as well as processing speed, and save energy:

- Vibration-resistant DR unit adopting a high-speed solid-state drive (SSD), thereby reducing the risk of data loss

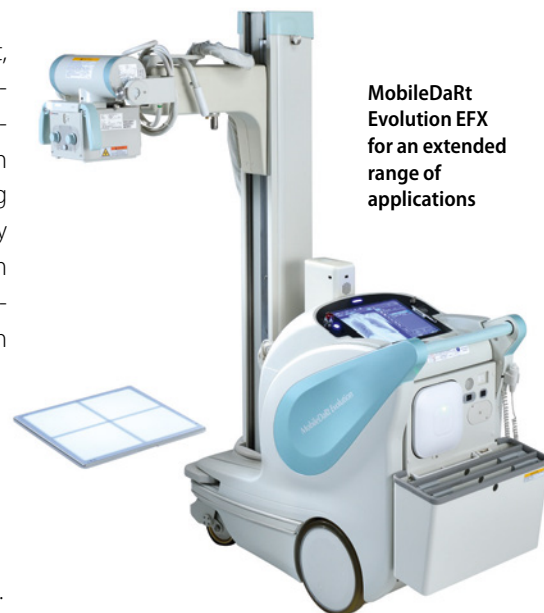

MobileDaRt Evolution EFX for an extended range of applications

- Energy saving collimator with a bright irradiation field through LEDs
- LCD monitor with a wide viewing angle around the unit
- FPD contributing to improved procedural efficiency.

### Opescope Acteno: C-arm with high operability and image quality

The Opescope Acteno surgical C-arm combines high image quality with ease of use. The system enables free and easy positioning and optimal performance to meet the demands of operation and emergency rooms. The fully counter-balanced C-arm provides extra-light and quick C-arm movements and positioning. The exclusive manual vertical C-arm movements enable much quicker height adjustments in routine operations.

Shimadzu's unique C-arm lock/release button at the image intensifier allows the C-arm to be positioned from the clinician's side without the need to go back to the cart unit. The enlarged 78 cm wide opening of the C-arm facilitates approaches to the patient, minimizing the risk of contact with the operating table.

Visit us at ECR 2015 in Vienna, Austria  
4-8 March 2015, Expo C, stand 325  
[www.shimadzu-medical.eu/](http://www.shimadzu-medical.eu/)

CONVENTIONAL

FUJIFILM · FCR Profect CS

**Slots** 4  
**Resolution** 5 – 20 pixel / mm  
**Capacity** 165 imaging plates (IPs) / h



**Highlights**

- EUREF & PAS 1054 compliant
- First mammography CR system approved by FDA
- 50 micron reading
- Needs 30 % less dosage for pediatric exams
- Dual side reading technology ensuring final images with higher DQE

FUJIFILM · FCR Prima T2

**Slots** 1  
**Resolution** 10 pixel / mm  
**Capacity** 73 imaging plates (IPs) / h



**Highlights**

- Tabletop CR system – compact footprint, only 0.30 m<sup>2</sup>
- Enhanced IP processability – stable and optimized images
- All-in-one workstation
- Quick display with simple operation
- Integrated management of image data and patient information
- Various diagnostic functions
- Less storage space
- Just 39 kg

FUJIFILM · FCR Prima II

**Slots** 1  
**Resolution** 10 pixel / mm  
**Capacity** 55 imaging plates (IPs) / h



**Highlights**

- Compact footprint, only 0.24 m<sup>2</sup>
- Enhanced IP processability
- Stable and optimized images
- All-in-one workstation
- Quick display with simple operation
- Various diagnostic functions
- Integrated management of image data and patient information
- Less storage space

FUJIFILM · FCR Capsula XL 2

**Slots** 1  
**Resolution** 5 – 20 pixel / mm  
**Capacity** 94 imaging plates (IPs) / h



**Highlights**

- IHE certified
- extremely compact system, mobile model available
- Universal applicable, wide dynamic range
- Compact frame and vertical cassette insertion for effective work space
- Ideal for medium radiologists
- Mammography application (optional)
- All-in-one unit for all diagnostic imaging needs
- Optional capability of 50-micron reading with high resolution imaging plates

FUJIFILM · FCR Capsula X

**Slots** 1  
**Resolution** 5 – 10 pixel / mm  
**Capacity** 72 Imaging plates (IPs) / h



**Highlights**

- IHE certified
- Extremely compact system, mobile model available
- Compact frame and vertical cassette insertion for effective work space
- Universal applicable, wide dynamic range
- Easy operations monitored on screen
- Ideal for medium radiologists (e.g. orthopaedic doctors)
- Optimized workflow

# RAD

# BOOK 2015

Please visit us at  
[www.healthcare-in-europe.com](http://www.healthcare-in-europe.com)

Konica Minolta · Regius 210

<b>Slots</b>	2
<b>Resolution</b>	3 – 11 Lp/mm
<b>Cassette size</b>	From 18x24 cm to 35x43 cm



**Highlights**

- High performance dual bay reader
- Outstanding image quality in both general X-ray and mammography
- Low dose imaging for paediatric use
- Use with standard cassettes and Csl cassettes (CP-1M, CP-1S)

Konica Minolta · Regius 110 HQ

<b>Slots</b>	1
<b>Resolution</b>	3 – 11 Lp/mm
<b>Cassette size</b>	From 18x24 cm to 35x43 cm



**Highlights**

- High quality mammography read function
- Easy to operate and maintain
- Powerful compact reader with linear motor technology
- Use with standard cassettes and/or mammography cassettes

Konica Minolta · Regius Sigma II

<b>Slots</b>	1
<b>Resolution</b>	3 – 6 Lp/mm
<b>Cassette size</b>	From 18x24 cm to 35x43 cm



**Highlights**

- Only 28 kg
- Foot print only 0.31 m<sup>2</sup>
- Processes up to 60 plates/hour
- Ultra compact: Konica Minolta's smallest and lightest CR reader
- Environmentally friendly with an energy consumption of max. 100 VA

DIGITAL

Agfa · DX-D 300

<b>kV Range</b>	From 40 to 150 kVp in 1 kVp step
<b>mAs Range</b>	From 0.1 to 500 mAs in 38 step



**Highlights**

- Universal modality
- Single DR detector
- MUSICA processing provides superior contrast detail and consistent, exam-independent image quality
- NX acquisition workstation offers comprehensive functionality for integrated workflow
- Integrated software for generator and positioner interface
- Complete versatility with optional CR/DR combination
- Motorized positioner
- Floor mounted

Agfa · DX-D 40 detector

<b>Detector</b>	Amorphous Silicon
<b>Size</b>	384 x 460 mm (outer dimension)
<b>Detector</b>	AED (Automatic Exposure Detection)
<b>Technology</b>	CsI and GOS

**Highlights**

- The DX-D 40 Digital Detector with Automatic Exposure Detection (AED) offers a fast and effective way for radiography facilities to benefit from high quality digital imaging using any X-ray equipment:
- Improved workflow and exam speed
  - Cassette-sized detector gives maximum convenience and portability
  - MUSICA processing for excellent contrast detail



Agfa · DX-D 600

<b>Power</b>	50 / 64 / 80 kW
<b>Detector</b>	CsI, 43 x 43 cm and 43 x 36 cm
<b>Pixel size</b>	139 µm



**Highlights**

- Family of systems from a manual system to a fully motorized auto-positioning system
- MUSICA processing provides superior contrast detail and consistent, exam independent image quality
- NX acquisition workstation offers comprehensive functionality for integrated workflow
- Automatic versions support DR detectors in the wall stand and table with optional additional integrated CR

DIGITAL

Agfa · DX-D 400

**Power** 50 / 64 / 80 kW



**Highlights**

- Flexible and affordable modality
- Family of systems from an analog manual system to a fully motorized auto-positioning DR system (shown here)
- MUSICA processing provides superior contrast detail and consistent, exam-independent image quality
- Supports CR and DR integration
- Requires limited space (4x 2 m)
- NX acquisition workstation offers comprehensive functionality for integrated workflow

Canon · DelftDI Adora DR

**Design** Ceiling-suspended DR system  
**Detector** Canon CXDI-series of high resolution DR detectors  
**Table** Motorised carbon fiber, floatig top with 340° rotation



**Highlights**

- Next generation High End solution for all radiographic applications
- Intelligent workflow for high volume patient throughput
- Easy APR auto-positioning – up to 1,000 positions
- SmartHandle motorized movement, zero force
- Intuitive tube head control
- Optional: – Integrated image stitching for total spine and total leg  
 – Fluoroscopic capability – RF  
 – Double tube head for RSA imaging procedures

Canon · DelftDI XSense DR

**Design** Ceiling-suspended DR system  
**Detector** Canon CXDI-series, high resolution DR detectors  
**Table** Motorised height adjustable with fixed tabletop



**Highlights**

- High End solution for all radiographic applications:
- Optimized workflow for high volume patient throughput
  - High efficiency with RIS-integrated workflow
  - Smart Automatic Positioning
  - Detector tracking in horizontal position
  - Designed around the patient
  - Generator interface on Tube head display
  - Acquisition workstation with large DICOM-calibrated touchscreen display

Canon · DelftDI Triathlon DR

**Design** Ceiling-suspended DR system  
**Detector** Canon CXDI-series, high resolution DR detectors  
**Table** Motorized height adjustable with floating tabletop



**Highlights**

- High End solutions for all radiographic applications:
- All radiographic applications can be performed
  - Floating tabletop
  - Smart Automatic Motorised Positioning
  - High efficiency because of RIS integrated workflow
  - Acquisition station with large DICOM calibrated touch screen display
  - Optional: Integrated image stitching for total spine and total leg

Canon · DelftDI Trauma DR PLUS

**Design** Ceiling-suspended U-arm trauma system  
**Detector** Canon CXDI-series, high resolution DR detectors



**Highlights**

- Versatile solution for trauma applications:
- Fast and efficient workflow
  - Easy manual positioning with motorized support for Z-movement
  - Large open workspace with a fixed focus – detector distance of 135 cm
  - Integrated cable management
  - C-Arm dept of 55cm
  - Integrated Dose Area Product Meter (DAP)
  - Acquisition station with large DICOM calibrated touch screen display

Please visit us at  
[www.healthcare-in-europe.com](http://www.healthcare-in-europe.com)



Canon · DelftDI Easy DR

**Design** Floor mounted X-Ray system  
**Detector** Canon CXDI-series, high resolution DR detectors

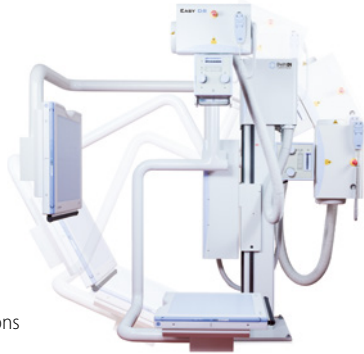

- Highlights**  
 Versatile solution for multi-purpose examinations
- Multipurpose floor mounted X-Ray system
  - Suitable for mobile installations (i.e. truck or container)
  - Retractable anti-scatter grid
  - Vertical and horizontal positioning of the U-arm
  - Acquisition station with DICOM calibrated touch screen display

Canon · DelftDI Intuition DR

**Design** Ceiling-suspended DR system  
**Detector** Canon CXDI-series, high resolution DR detectors  
**Table** With floating table



- Highlights**  
 Versatile solution for all radiographic applications:
- Optimized workflow for medium volume patient throughput
  - High efficiency with RIS integrated workflow
  - Lightweight manual Alpha, Beta, X- and Y-movement
  - Motorized Z-movement, floating tabletop
  - Smart Chest and table tracking
  - Acquisition station with large DICOM calibrated touch screen display
  - Easy to fit in low ceiling X-ray rooms

DMS / APELEM · Camargue HQ DR

**Power** 50 / 65 / 80 kW  
**Detector** Csl or Gadox  
**Size** 36x43 cm Wifi / 43x43 cm, 41 x43 cm Fix



- Highlights**  
 The Camargue series was designed to ensure the best radiographic performance.  
 Several model are available:
- Manual ceiling suspension
  - Auto tracking
  - Fully motorized, 5 axes
  - Variable height table
- Different configuration available with:
- One portable detector wifi + flat panel detector
  - 2 flat panel detectors



# Radiology for the Future.

Based on more than 140 years of imaging expertise, Agfa HealthCare is your trusted radiology partner for the future. Today, only a small number of patients receive the lowest X-ray dose technically possible, our digital radiography upgrade program, “Fast Forward”, drives dose down with 50% and more. The radiologist is the diagnostician of the future: by providing the clinician with actionable knowledge about the patient treatment, the radiologist will be at the center of the patient’s care.



Learn about Agfa HealthCare at [www.agfahealthcare.com](http://www.agfahealthcare.com)

DIGITAL

DMS / APELEM · Da Vinci Solo

**Power** 50 / 65 / 80 kW  
**Detector** 43 x 43 cm, 143 µm, 14 bits, fix grid  
**Detector** 36 x 43 cm Wifi

**Highlights**

The Da Vinci Solo is a universal single detector system which has been designed to provide maximum flexibility and patient workflow for general radiography.

Full motorized:

- Detector tilting: ±45°
- Arm rotation: +120° / -30° (±90°)
- Vertical movement of the stand: 126.5 cm
- Variable focus-film distance (SID): 100 to 180 cm
- Min. / max. focal distance to floor: 45 – 200 cm



**Buy & sell used equipment on**



[www.dotmed.com](http://www.dotmed.com)

**Over 400,000 listings**  
**Over 20,000 daily visitors**

FUJIFILM · FDR AcSelerate CSI

**Power** 65 / 80 kW  
**Detector** CSI Scintillator combined irradiation side sampling (ISS); two fixed detector system; resolution: 150 µm, 2,880x2,880 pixel; third panel optional; wired or wireless  
**Size** Optional third panel D-Evo Csl Series: 35 x 43 cm, 24 x 30 cm

**Highlights**

- Thomosynthesis optional
- Energy subtraction optional
- Image stitching optional
- 2 s image preview – 4 s interval exposure time
- Fully automated functionality as standard
- Auto-positioning, auto-tracking, auto-collimation, auto-filtering
- Fully motorized



FUJIFILM · FDR AcSelerate Flex

**Power** 65 / 80 kW  
**Detector** CSI Scintillator combined irradiation side sampling (ISS); fixed Csl detector in wall stand; resolution: 150µm, 2,880x2,880 pixel  
**Size** Optional second panel D-Evo Csl Series: 35 x 43 cm, 24 x 30 cm

**Highlights**

- Chest thomosynthesis optional
- Image stitching optional
- 2 s image preview – 4 s interval exposure time
- Fully automated functionality as standard
- Auto-positioning, auto-tracking, auto-collimation, auto-filtering
- Fully motorized
- Dynamic visualization
- Table with bucky tray

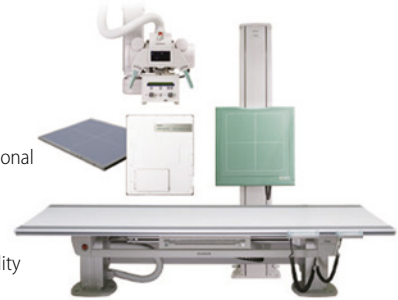

FUJIFILM · FDR D-Evo Suite

**Power** 65 / 80 kW  
**Detector** D-Evo Series GOS & Csl supported; IIS indirect conversion method  
**Size** variable 35 x 43 cm or 43 x 43 cm

**Highlights**

- 3 s image preview
- 9 s interval exposure time
- Lightweight ceiling suspension universal flat panel X-ray room
- Motorized floating top table, max. 250 kg patient load
- Motorized vertical tube
- ISS conversion method improves DQE & MTF significantly
- X-Con connection



FUJIFILM · RX Evo – F

**System concept** Space saving and cost efficient floor mounted x-ray room solution  
**Detector** D-Evo Series GOS & Csl supported; IIS indirect conversion method

**Highlights**

- The RX EVO-F is a powerful, easy to use X-Ray system offering high performance for the operator while maintaining a pleasant atmosphere for patients.
- This complete x-ray room solution delivers excellent exposure output supporting a comprehensive range of examination techniques in orthopaedic, surgical and urological applications.
- The system comes with the so called Harmony Lighting Option.



FUJIFILM · Visionary Suite

**Power** 80 / 65 / 50 kW  
**Size** Dual Panel Lineup- D-Evo Advanced Csl 43 x 43cm panel and/or D-Evo Series: 43 x 43 cm, 35 x 43 cm, 24 x 30 cm

**Highlights**

- Fully scalable solution: full manual to full autopositioning options and upgrades available
- Color touchscreen display on the tube head makes it possible to confirm and change exposure conditions in the examination room
- Wired remote control option for control of automated system movements
- Energy subtraction, Tomosynthesis and image stitching options



GE Healthcare · Discovery XR656

**Power** 50 / 65 / 80 kW  
**Detector** Cesium Iodide Scintillator, 41 x 41 cm  
**Pixel size** 200 µm

**Highlights**

- Excellent image quality
- Fully motorized tube suspension with autopositioning
- Auto Field of View
- Advanced applications: VolumeRAD, dual energy, auto image pasting
- Four different configurations with FlashPad wireless detector



GE Healthcare · Definium 5000

**Power** 65 kW  
**Detector** a-Silicon, 41 x 41 cm  
**Pixel size** 200 µm

**Highlights**

- Flexible DR solution with fast and proven detector technology
- Excellent image quality at low dose
- Easy to install and operate
- Seamless digital workflow
- Pasting optional



GE Healthcare · Definium 6000

**Power** 50 / 65 / 80 kW  
**Detector** a-Silicon, 41 x 41 cm  
**Pixel size** 200 µm

**Highlights**

- Fast and proven detector technology
- More flexibility with mobile "flying" detector
- Fully motorized wall stand
- OTS with vertical auto-tracking
- Optional advanced applications
- Seamless digital workflow
- Flexible configurations, including cost-effective 1-detector shared solution



# RAD

# BOOK 2015

Please visit us at  
[www.healthcare-in-europe.com](http://www.healthcare-in-europe.com)

GMM · CALYPSO – Multifunctional DR system

**Design** Ceiling suspended-double detector system  
**Detector** Fixed or portable  
**Table** Adjustable height

**Highlights**

- Enhanced Direct digital radiology in Trauma, ER, routine and specialized examinations.
- Preset for receiving two digital flat panel detectors either fixed or WiFi.
- Adjustable height examination table for easy and safe patient positioning.
- Exclusive interlocking technology ensuring automatic alignment of the X-ray source to the detector movement.
- Advanced digital system with optional stitching.



## DIGITAL

### GMM · CALYPSO F – Multifunctional DR system

<b>Design</b>	Floor fixed system with double detector
<b>Detector</b>	Fixed or portable
<b>Detector</b>	35 x 43 cm and 43 x 43 cm

#### Highlights

- User-friendly integrated solution for direct digital radiology application.
- Adjustable height examination table floating in the four directions.
- X-ray tube column stand sliding on rails combined with examination table and wall stand.
- Column stand rotation around its vertical axis for an easy and safe execution of lateral projections.
- Advanced digital system for image acquisition and processing.

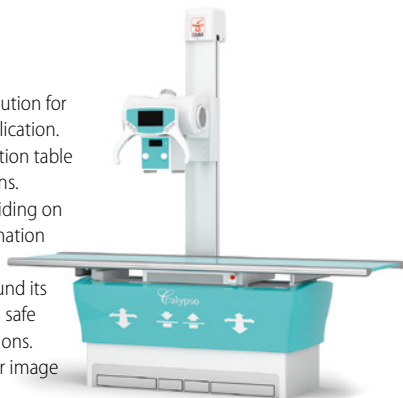

### Konica Minolta · AeroDR X50

<b>Power</b>	32 – 80 kW
<b>Detector</b>	AeroDR CsI FPD 14" x 17" / 17" x 17" / 10" x 12"
<b>Pixel size</b>	175 µm

#### Highlights

- High image quality, low dose
- Compact
- Suits small rooms
- Optional stitching
- AeroDR detector can be used in table, wallstand or outside of bucky



### Konica Minolta · AeroDR X70

<b>Power</b>	50 – 80 kW
<b>Detector</b>	AeroDR CsI FPD 14" x 17" / 17" x 17" / 10" x 12"
<b>Pixel size</b>	175 µm

#### Highlights

- Multiple configurations possible
- Light handling, servo tracking standard
- Excellent workflow in combination with AeroDR detector
- Intuitive CS-7 console
- Can be installed in rooms with a minimal height of 2.5 metres



### Mecall · EIDOS 3000 – Single/ Dual FDP DR system

<b>Detector</b>	Amorphous silicon
<b>Resolution</b>	143 µm
<b>Size</b>	43 x 43 cm; 35 x 43 cm WiFi

#### Highlights

- State-of-the-art system with single detector and removable grid with exclusive auto-focusing device.
- Single end suspended and pivoting tabletop for fast and easy treatment of patients on stretcher
- Full-length patient examination
- Advanced ceiling suspension with motorized movements
- Auto positioning features driven by anatomical programs
- Advanced image processor technology for perfect images at a consistent low dose



### Mecall · KALOS – Single / Dual / Triple FPD DR system

<b>Detector</b>	Amorphous silicon
<b>Resolution</b>	148 µm
<b>Size</b>	43x43 cm; 35x43 cm Wi-Fi; 24x30 cm Wi-Fi

#### Highlights

- Advanced elevating table with detector floating in longitudinal and lateral direction
- Automatic alignment of the detector with the x-ray beam
- Useful radiographic area > 2 m including lateral projections
- Auto positioning features driven by anatomical programs
- Advanced image processor fully integrated into ceiling suspension touch screen



### medigration · DigiRoebis Z IS

<b>Power</b>	55 kW
<b>Detector</b>	Flatpanel s-Si, CsI, 43 x 43 cm
<b>Pixel size</b>	148 µm, 16 bit

#### Highlights

- Easy to use X-ray device for all exam techniques at standing, sitting or lying patients
- Swivel arm rotation: -30° to +135°
- Real-time image processing within a few seconds
- Single touch screen console controls generator and acquisition software
- Image quality and contrast detail with medigration image processing software "HARMONY"
- DICOM services: print, store, query / retrieve, MPPS, WL





## Primax · RIVIERA DR

<b>Power</b>	Up to 80 kW
<b>Detector</b>	Wireless or fixed flat panel
<b>Design</b>	Floor mounted column on rails

**Highlights**

- Fixed or variable height floating tabletop
- Last generation ultralight wireless flat panel
- Excellent image quality
- Easy to install
- Full touch interface
- Cost effective



# Buy & sell used equipment on



[www.dotmed.com](http://www.dotmed.com)

**Over 400,000 listings**  
**Over 20,000 daily visitors**

## PROTEC · PEDS 600 DR/Touch

<b>Power</b>	40 / 50 / 65 / 80 kW
<b>Detector</b>	Different panel and scintillator versions, max. 43x43 cm
<b>Pixel size</b>	e.g. 139 µm

**Highlights**

- DR-System with digital flat panel detector
- PROVARIO HF generator (40 – 80 kW)
- Anatomical programs and AEC
- Variable SID 110 – 200 cm
- Rotatable U-arm – 30° up to +135°
- Rotatable DR-detector
- "Touch" version: high-end solution with integrated image acquisition through touch-display directly at the system (compare: PRS 500 F/E DR Touch)



## PROTEC · PRS 500 F/E DR Touch

<b>Power</b>	40 / 50 / 65 / 80 kW
<b>Detector</b>	Different single or dual panel systems, max. 43x43 cm
<b>Pixel size</b>	e.g. 139 µm

**Highlights**

- Integrated state-of-the-art touch concept
- Radiographic positioning aid directly at the system
- Patient selection, job selection and generator control at integrated touch-screen
- First preview at the system immediately after the exposure
- Outstanding ease of use due to ideal workflow, simple handling and the selection of the patient at the X-ray system directly



## PROTEC · PRS 500 F / E DR

<b>Power</b>	40 / 50 / 65 / 80 kW
<b>Detector</b>	Different single or dual panel systems, max. 43x43 cm
<b>Pixel size</b>	e.g. 139 µm

**Highlights**

- PROVARIO HF generator integrated into the table (40 – 80 kW)
- APR and AEC
- Automatic coupling device to center tube and bucky
- Including wall bucky stand; stitching as optional solution
- Floating carbon fibre table top
- Fully digital DR-System with flat panel detector technology, different configurations possible from single to dual detector systems
- Adjustable height with PRS 500 E DR



## PROTEC · PRS 500 X / XPE DR

<b>Power</b>	40 / 50 / 65 / 80 kW
<b>Detector</b>	Different panel and scintillator versions, max. 43x43 cm
<b>Pixel size</b>	e.g. 139 µm

**Highlights**

- Easy system handling and positioning due to its optimum weight counterbalance concept
- Maximum flexibility and workflow efficiency
- Outstanding variability and extensibility in case of changing application requirements (e.g. upgrading with extended floor-rail)
- Fully digital X-ray generator connection by CONAXX image acquisition software
- Also available as TOUCH Version (see PRS 500 F / E)



DIGITAL

Shimadzu · RADspeed DR

**Power** 50 / 65 / 80 kW  
**Detector** Flat panel detector (a-Si)  
**Pixel size** 160 / 125 µm



**Highlights**

- Flexible choice of different flat panel detectors
- Excellent image quality
- Auto-positioning function
- Superb dose efficiency
- Seamless network integration
- Size: 17" x 17" (43 x 43 cm)  
14" x 17" (35 x 43 cm)  
9" x 11" (23 x 28 cm)

Shimadzu · RADspeed DR wireless\*

**Power** 50 / 65 / 80 kW  
**Detector** Flat panel detector (a-Si)  
**Pixel size** 125 µm



**Highlights**

- New generation with wireless flat panel detector
- Excellent image quality
- Auto-positioning function
- Superb dose efficiency
- Seamless network integration
- Size: 17" x 17" (43 x 42 cm) / 14" x 17" (35 x 43 cm) / 14" x 11" (35 x 27 cm)

\* System configuration available in selected countries only

Shimadzu · RADspeed Pro V4

**Power** 80 / 65 / 50 kW  
**Detector** 17"x17", 14"x17"  
**Pixel size** 139 µm



**Highlights**

- Fully integrated operation system
- Flexible and easy to use X-ray tube support
- Various FPD line-up: 17"x17" / 14"x17" (portable wired, wireless)
- Synchronized functions: auto positioning, auto tracking, auto collimation, speed stitching
- Comprehensive dose management

Siemens · Multix Fusion

**Power** 55 / 65 / 80 kW  
**Detector** a-Si / CsI  
**Size** 35 x 43 cm, 139 µm, fixed detector 43 x 43 cm



**Highlights**

- Key components adapted from Ysio
- Outstanding images enhanced by DiamondView Plus
- Automation – Fast positioning with advanced tube tracking and comfortable maneuvering
- Wireless detector with only 3.5 kg and just 16 mm
- Optional fixed 43 x 43 cm CsI detector in wall stand
- GuidedOrtho – easy to use guidance and automation to acquire and compose long leg and long spine images

Siemens · Multix Select DR

**Power** 55 kW  
**Detector** aSi / GOS  
**Size** 35 x 43 cm, 139 µm



**Highlights**

- Robust mobile flat detector to cover full spectrum of clinical applications
- Imaging system from Siemens' high-end product line (e.g. Ysio Max, Multix Fusion) enhanced by DiamondView Plus
- Intelligent automation with organ preset programs to speed setup and improve reproducibility
- High system reliability and availability
- High flexibility – for seamless head-to-toe exams of patients up to 190 cm

Siemens · Ysio Max

**Design** Ceiling-mounted tube  
**Detector** a-Si / CSI  
**Size** MAX wi-D 43 x 35 cm, MAX mini 24 x 30 cm, MAX static 43 x 43 cm



**Highlights**

- Ysio MAX – the most direct way to the image.
- Unique simultaneous FAST movement in 6 axes
- MAXalign – makes free exams dramatically faster and easier
- MAX wi-D – only 3 kg, just 19 mm thin, image preview within 2 seconds
- MAX mini – the right size for orthopedic, pediatric and trauma exams
- MAXswap – the right way to share detectors with a safe, quick and easy one-click registration

## STEPHANIX · RAD Series Pro DReam

**Design** Customizable floor tubestand RAD room  
**Technology** Up to 3 Flat Panel Detectors, indirect conversion  
**Detector** Fixed and wireless solutions

**Highlights**

- Manual or vertical tracking version
- Single or multi-detectors room
- Fixed or tilting wall Bucky
- Floating elevating tabletop for patient weight up to 250 kg
- Intuitive user interface with unlimited preset APR
- Possibility to share wireless detectors with different Stephanix modalities



## STEPHANIX · Xtreme DReam

**Design** Customizable ceiling RAD room  
**Technology** Up to 3 Flat Panel Detectors, indirect conversion  
**Detector** Fixed and wireless solutions

**Highlights**

- Manual, vertical tracking or autopositioning version
- Single or multi-detectors room
- Fixed or tilting wall Bucky
- Floating elevating tabletop for patient weight up to 300 kg
- Intuitive user interface with unlimited preset APR
- Possibility to share wireless detectors with different Stephanix modalities

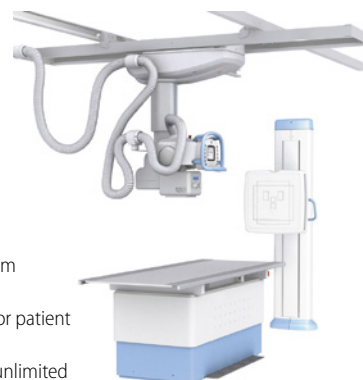

## STEPHANIX · Statif Pro DReam

**Design** Universal autocentred C-arm DR unit  
**Detector** Full-field or portable flat panel detector  
**Motorized Table** Automatic positioning, collimation, filtration, parameters  
**Table** Optional carbon or elevating tabletop, on wheels

**Highlights**

- Low footprint for wide range of procedures at standing, sitting or lying patient
- C-arm shaped for cross exams
- Autopositioning regarding each protocol
- Automatic and virtual collimation, additional filtration
- User-friendly interface
- Wireless remote



## STEPHANIX · Statif DReam

**Design** Cost-efficient universal autocentred DR unit  
**Detector** Full-field or portable flat panel detector  
**Table** Optional carbon or elevating tabletop, on wheels

**Highlights**

- Multipurpose DR solution for small budgets
- It can be dedicated to chest and extremities examinations
- Low footprint for wide range of procedures at standing, sitting or lying patient
- Manual or motorized (SID and vertical movement)
- User-friendly interface



## Swissray · ddRFormula Plus

**Power** 65 / 80 kW  
**Detector** a-Si CsI, 43 x 43 cm  
**Pixel size** 148 µm

**Highlights**

- Fully automated Positioning System (APS) for highest patient throughput
- 1,296 pre-programmed APR's
- Hand held remote control
- Superb diagnostic IQ with high contrast details
- Single Focus eXpertStitching function for orthopedic imaging
- Off-center and off-detector imaging capability
- Integrated video camera to monitor patient and ensure positioning
- Multi language capability



## Swissray · ddRElement

**Power** 50 / 65 kW  
**Detector** a-Si CsI, 43 x 43 cm  
**Pixel size** 148 µm

**Highlights**

- Space efficient, multifunctional DR system fits into very small X-ray rooms
- Built in 43 x 43 cm flat panel detector delivers superb image quality in a few seconds
- Multiple language capability
- Robust and reliable design
- Easy and intuitive to use, includes digital positioning guide
- Off-center and off-detector imaging capability
- Workflow optimization through advanced eXpert and SwissVision user interface



DIGITAL

Swissray · Portable Detector

**System concept** Leight weight  
**Detector** a-Si Csl, 35 x 43 cm WiFi  
**Pixel size** 148 µm  
 2.8 kg



**Highlights**

- Innovative technology delivers excellent image quality
- Cassette size ISO 4090, only 15 mm thickness
- Automatically detects detector placement (table, wall stand or free exposures)
- 35 x 43 cm active image area, 25 image storage capacity
- Fast WIFI Image transmission
- Preview in 3 seconds, fully processed image in less than 10 seconds
- Ergonomic handling thanks light weight of less than 2.8 kg
- Rechargeable batteries with 8 hours working time
- Very robust and solid design

Toshiba Electron Tubes & Devices · FDX 2530 RPW

**System concept** Wireless flat panel detector  
**Detector** Csl/Tl, 25 x 30 cm  
**Pixel size** 140 µm



**Highlights**

- Wireless compact FPD
- Incorporates Toshiba's proven advanced fine Csl/Tl and direct deposition technologies
- Moisture-proof sealing method used for the Csl/Tl screen
- Automatic switching between wireless/ tethered mode
- Short cycle time (less than 10 s)
- Recharging in tethered mode
- Detachable cable connector
- Lightweight: 1.7 kg
- AED available
- Compact and lightweight battery recharger

Toshiba Electron Tubes & Devices · FDX 3543 RPW / FDX 4343 RPW

**System concept** Wireless flat panel detector  
**Detector** Csl/Tl, 43 x 43 cm, 35 x 43 cm  
**Pixel size** 140 µm



**Highlights**

- Wireless type Portable FPD
- Incorporates Toshiba's proven advanced fine Csl/Tl and direct deposition technologies
- Unique moisture-proof sealing method used for the Csl/Tl screen
- Standard cassette size
- Automatic switching between wireless/tethered mode
- Short cycle time (less than 10 s)
- Recharging in tethered mode
- Detachable cable connector
- Compact and lightweight battery recharger

Toshiba Electron Tubes & Devices · FDX 4343 R

**System concept** Static flat panel detector  
**Detector** Csl/Tl, 43 x 43 cm  
**Pixel size** 143 µm

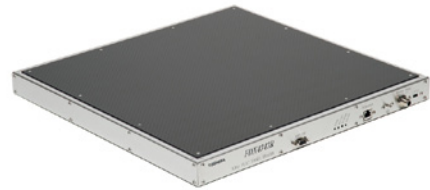

**Highlights**

- Toshiba's proven advanced fine Csl/Tl and direct deposition technologies provide high DQE and excellent resolution.
- The reflective coating in the Csl/Tl screen provides high sensitivity.
- Unique moisture-proof sealing method provides an extremely reliable Csl/Tl screen that is protected from degradation.
- Prompt display of preview/ full images and short cycle time enable fast image acquisition .

**Buy & sell used equipment on**



[www.dotmed.com](http://www.dotmed.com)

**Over 400,000 listings**  
**Over 20,000 daily visitors**

Toshiba · RADREX-i

**Power** 80 kW  
**Detector** a-Si Csl  
**Pixel size** 139 µm



**Highlights**

This digital radiography system is a new-concept system that permits radiography to be performed easily and with greater accuracy. In this system, the operating sections for the digital image processor and the X-ray high-voltage generator are integrated, and the use of an integrated panel improves workflow.



VILLA SISTEMI MEDICALI · ArmonicUs

**Power** 50/65/80 kW  
**Detector** a-Silicon detector with CsI scintillator, 43x43 cm  
**Pixel size** 143 µm

**Highlights**

- Cost-effective DR U-arm system for extended use, including general radiographic and orthopedic studies
- Easy patient positioning via APR functions
- Auto-positioning capabilities according to RIS procedure codes
- Touch screen control panel, secondary keyboard and infrared remote control as standard
- Variable Source to Image Distance up to 180 cm
- On-board parking station for two grids



VILLA SISTEMI MEDICALI · D-View

**Power** 50/65/80 kW  
**Detector** a-Silicon detector with CsI scintillator, 43 x43 cm  
**Pixel size** 143 µm

**Highlights**

- Single detector DR system for all general radiographic, skeletal, chest, emergency applications
- Tilting detector support with motorized inclination -20° / +90°
- Ceiling tubestand with vertical auto-tracking function to automatically keep the alignment between the tube and the detector
- Two removable and interchangeable grids
- Choice of different mobile patient tables



VILLA SISTEMI MEDICALI · Moviplan iC

**Power** 32/40/50/65/80 kW  
**Detector** a-Silicon detector with CsI conversion screen, 35x43 cm  
**Pixel size** 143 µm

**Highlights**

- Innovative design with no unsightly cables
- Anti-collision system and reduced thickness rails
- Table commands with distinctive "light barrier"
- Touch Screen interface for immediate inputs
- No patient limitation thanks to high weight capacity
- Electronic tomography with free selection of angle
- Available as analog or digital, with wired or wireless detectors

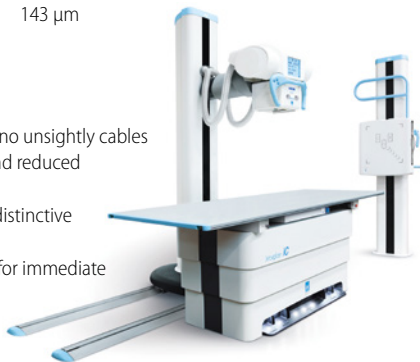

Wandong · New Oriental 1000

**Power** 50 kW  
**kV Range** 40 ~ 150 kV  
**Detector** 43 x43cm (17 x17")  
**Resolution** 3.6 lp/mm

**Highlights**

- High frequency 50 kW generator
- 600 APR programs
- Classical mechanical structure for all needs of clinical application
- X-ray tube auto tracking with the vertical bucky
- Fixed or portable 17 x 17" FPD
- InvaRay digital imaging platform with DICOM 3.0 compliance



Wandong · New Oriental 1000 Fully Automatic

**Power** 80 kW  
**Detector** 43x43 cm FPD  
**Pixel size** 148 µm

**Highlights**

- 80 kW high frequency generator
- Advanced FPD detector
- Ceiling suspending structure meet all kinds of clinical needs
- 5 axis electric control
- Advanced patient protection technology
- More than 600 APR programs for doctor
- Auto positioning function
- Fast position switch
- High acquisition speed
- Remote control available



Wandong · New Oriental 1000 U-arm DR

**Power** 50 kW  
**kV Range** 40 – 150 kV  
**Detector** FPD 17 x 17"

**Highlights**

- NEW ORIENTAL 1000 U-arm DR is a versatile digital X-ray system to meet customer demands of digital diagnosis. Less dose and faster acquisition.
- 600 APR Programs
- Compact U-arm structure with motorized rotation and vertical movement is an ideal solution for inadequate installation space
- High frequency Generator
- 17 x 17" FPD
- InvaRay digital acquisition with DICOM 3.0 compliance

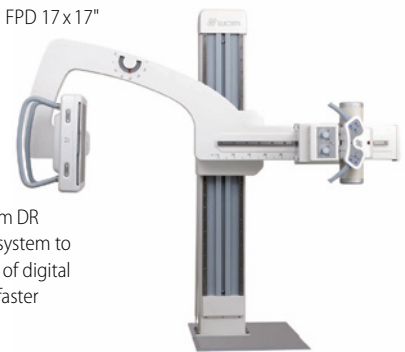

DIGITAL

Wandong · New Oriental 1000 CCD DR

<b>Power</b>	50 kW
<b>kV Range</b>	40~150 kV
<b>Detector</b>	43 x 43 cm (17 x 17")
<b>Resolution Matrix</b>	3k x 3k



**Highlights**

- NEW ORIENTAL 1000 U-arm CCD DR is a versatile digital X-ray system to meet customer demands of digital diagnosis. Less dose and faster acquisition.
- High frequency 50 kW generator
- 600 APR programs
- U-arm compact structure fits for inadequate room space
- Electric vertical and rotating movement
- Full field, single CCD, 17 x 17"
- InvaRay digital imaging platform with DICOM 3.0 compliance

DR RETROFIT

Agfa · DX-D 10G / C Retrofit

<b>System concept</b>	Tethered
<b>Detector</b>	Choice of Cesium Iodide (CsI) or Gadolinium Oxy-Sulphide (GOS) detector conversion screens
<b>Pixel size</b>	139 µm



**Highlights**

- Offers convenience and portability
- Improves workflow and exam speed
- Superior connectivity to PACS, HIS / RIS and imagers
- Small pixel size gives more image information for improved diagnostic effectiveness
- MUSICA image processing for superior contrast detail and exam-independent, consistent image quality

Agfa · DX-D 30C Retrofit

<b>Size</b>	46 x 38,4 x 1.5 cm
<b>System concept</b>	Wireless
<b>Detector</b>	Cesium Iodide (CsI) detector conversion screen
<b>Pixel size</b>	125 µm



**Highlights**

- Detector is the size of a cassette, for maximum convenience and portability
- MUSICA processing for superior contrast detail and exam-independent, consistent image quality
- Improves workflow and exam speed
- Superior connectivity to PACS, HIS / RIS and imagers
- Cesium Iodide (CsI) detector conversion screen
- Small pixel size gives more image information, for improved diagnostic effectiveness

Canon · Canon DR-Upgrade-within-2-minutes

<b>System concept</b>	DR Upgrade within 2 minutes
<b>Design</b>	2 components
<b>Resolution</b>	125 µm
<b>Cassette size</b>	43 x 42 cm, 35 x 43 cm, 27.4 x 35 cm



**Highlights**

- Easy upgrade solution for any X-ray system in two minutes using just two components
- No connections or modifications to your existing X-ray system is necessary
- With CXDI-401C / 701C / 801C Wireless Flat Panel Detectors
- Optional USB DAP-meter for dose registration
- DR Upgrade within 2 minutes. Freedom within reach

Canon · Canon CXDI-401C / 701C / 801C Wireless

<b>Technology</b>	Cesium Iodide Scintillator
<b>Resolution</b>	125 µm
<b>Size</b>	Various

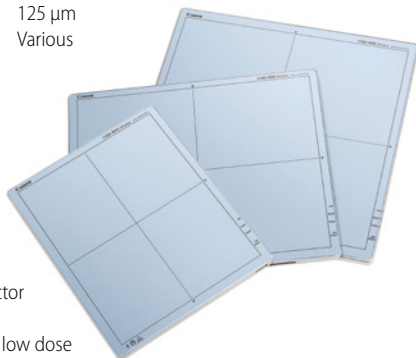

**Highlights**

- Wireless flat panel detector series
- Lighter, high resolution, low dose
- Easy upgrade with just two components
- Includes Non-Synchronised exposure
- Thin and lightweight
- Preview image time in 3 s
- Sophisticated image processing software
- Interchangeable between rooms

DMS / APELEM · EZ2GO

<b>Design</b>	DR Upgrade mobile in 2 minutes
<b>System concept</b>	2 components
<b>Detector</b>	36 x 43 or 24 x 30 cm



**Highlights**

- Connect up to 3 wifi flat panel detectors
- Image preview in 2 s and image acquisition in 4 s
- 8 h battery / autonomy
- The cassette size of the detector allows upgrade everywhere in the hospital
- Ideal for control exams for bedridden patients
- The lightest solution of the market (3.9 kg tablet + detector)

## FUJIFILM · D-Evo G43i

**System concept** Cassette size detector with irradiation side sampling (ISS)  
**Detector** GOS (gadolinium oxysulfide)  
**Size** 460x460x15mm (WxDxH)

**Highlights**

- Square shaped – standard size 43 x 43 cm DR cassette
- Light weight 4 kg (including battery)
- 500 exposures or 3.5 h use per full battery charge – on the fly battery change
- Automatic X-ray detection (SmartSwitch function)
- For table, upright and portable applications
- 2 s preview time – 8 s exposure cycle time

## FUJIFILM · D-Evo II G43

**System concept** Cassette size detector with irradiation side sampling (ISS)  
**Detector** GOS (gadolinium oxysulfide)  
**Size** 460x460x15 mm

**Highlights**

- Square shaped – standard size 43 x 43 cm DR cassette
- Shell Design
- Light weight 3.2 kg
- Weight Loading: 310kg
- Panel Status Indicator
- Extended Battery Life of up to 18.5 h
- 10 sec readout for Functional Imaging
- Waterproof, IPX6
- Inbuilt Panel Memory, storage for 100 images
- Automatic X-ray detection (SmartSwitch function)

## FUJIFILM · D-Evo C43i

**Highlights**

- Standard size 43x43 cm DR cassette
- Light weight 4.2 kg (including battery)
- 500 exposures or 3.5 h use per full battery charge – on the fly battery change
- Automatic X-ray detection (SmartSwitch function)
- For table, upright and portable applications
- 2 s preview time – 9 s exposure cycle time
- Auto-recognition of the examination area and film sized trimming

## FUJIFILM · D-Evo II C43

**System concept** Cassette size detector with irradiation side sampling (ISS)  
**Detector** CSI Scintillator combined irradiation side sampling (ISS)  
**Size** 460x460x15 mm

**Highlights**

- Square shaped – standard size 43 x 43 cm DR cassette
- Shell Design
- Light weight 3.2 kg
- Weight Loading: 310kg
- Panel Status Indicator
- Extended Battery Life of up to 18.5 h
- 10 sec readout for Functional Imaging
- HydroAG Antibacterial Coat
- Waterproof, IPX6
- Inbuilt Panel Memory, storage for 100 images
- Automatic X-ray detection (SmartSwitch function)

## FUJIFILM · D-Evo G35s

**System concept** Cassette size detector with irradiation side sampling (ISS)  
**Detector** GOS (gadolinium oxysulfide)  
**Size** 384x460x14.8 mm (WxDxH)

**Highlights**

- For table, upright and portable applications
- Only 2.8 kg and 14 mm thick
- 3 s preview time
- 9 s exposure cycle time
- Imaging area: 35 x 43 cm
- ISS conversion method improves DQE and MTF significantly

## FUJIFILM · D-Evo II G35

**System concept** Cassette size detector with irradiation side sampling (ISS)  
**Detector** GOS (gadolinium oxysulfide)  
**Size** 384x460x14.8 mm

**Highlights**

- Standard size 35 x 43 cm DR cassette
- Shell Design
- Light weight 2.6 kg
- Weight Loading: 310kg
- Panel Status Indicator
- Extended Battery Life of up to 18.5 h
- 10 sec readout for Functional Imaging
- HydroAG Antibacterial Coat
- Waterproof, IPX6
- Inbuilt Panel Memory, storage for 100 images
- Automatic X-ray detection (SmartSwitch function)

DR RETROFIT

FUJIFILM · D-Evo C35i

**System concept** Cassette size detector with irradiation side sampling (ISS)  
**Detector** CSI Scintillator combined irradiation side sampling (ISS)  
**Size** 460x384x15mm (WxDxH)



**Highlights**

- Standard size 35 x 43 cm DR cassette
- Light weight 3.6 kg (including battery)
- 500 exposures or 3.5 h use per full battery charge – on the fly battery change
- Automatic X-ray detection (SmartSwitch function)
- For table, upright and portable applications
- 1 s preview time – 8 s exposure cycle time
- Auto-recognition of the examination area and film sized trimming

FUJIFILM · D-EvoII C35

**System concept** Cassette size detector with irradiation side sampling (ISS)  
**Detector** CSI Scintillator combined irradiation side sampling (ISS)  
**Size** 384x460x15 mm



**Highlights**

- Standard size 35 x 43 cm DR cassette
- Shell Design
- Light weight 2.6 kg
- Weight Loading: 310kg
- Panel Status Indicator
- Extended Battery Life of up to 18.5 h
- 10 sec readout for Functional Imaging
- HydroAG Antibacterial Coat
- Waterproof, IPX6
- Inbuilt Panel Memory, storage for 100 images
- Automatic X-ray detection (SmartSwitch function)

FUJIFILM · D-Evo C24i

**System concept** Cassette size detector with irradiation side sampling (ISS)  
**Detector** CSI scintillator combined irradiation side sampling (ISS)  
**Size** 328x268x15mm (WxDxH)



**Highlights**

- Small Size 24 x 30 cm DR cassette
- As thin as a regular X-ray cassette
- Light weight 1.9 kg (including battery)
- 700 exposures or 4 h use per full battery charge
- On the fly battery change
- 1 s switch between wired or wireless mode
- Automatic X-ray detection (SmartSwitch function)
- 1 s preview time/ 7 s exposure cycle time

FUJIFILM · D-EvoII C24

**System concept** Cassette size detector with irradiation side sampling (ISS)  
**Detector** CSI Scintillator combined irradiation side sampling (ISS)



**Highlights**

- Small Size 24 x 30 cm DR cassette
- As thin as a regular X-ray cassette
- Shell Design
- Panel Status Indicator
- Extended Battery Life of up to 18.5 h
- Extended readout for Functional Imaging
- HydroAG Antibacterial Coat
- Waterproof
- Inbuilt Panel Memory
- Automatic X-ray detection (SmartSwitch function)

FUJIFILM · D-Evo G35i

**System concept** Cassette size detector with irradiation side sampling (ISS)  
**Detector** GOS (gadolinium oxysulfide)  
**Size** 384x460x14.8 mm (WxDxH)



**Highlights**

- Standard size 35 x 43 cm DR cassette
- Light weight 3.3 kg (including battery)
- 750 exposures or 3.5 h use per full battery charge – on the fly battery change
- Automatic X-ray detection (SmartSwitch function)
- For table, upright and portable applications
- 2 s preview time – 11 s exposure cycle time
- Auto-recognition of the examination area and film sized trimming

GE Healthcare · FlashPad wireless detector

**Technology** Cesium Iodide Scintillator  
**Detector** 2,022x2,022 pixel, 14 bit  
**Size** 41 x 41 cm



**Highlights**

- Advanced applications capability
- Ultra wide band communications
- High IQ, low dose
- Improved positioning
- More comfortable handling
- Advanced construction



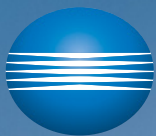

KONICA MINOLTA

Robust

Reliable

Waterproof...?



## Robust, reliable, waterproof. The new AeroDR Premium.

Konica Minolta's AeroDR Premium is IPX6 waterproof, making it very suitable to use under the extreme conditions that clinical staff face every day. Whether at work in an Emergency Room, Intensive Care Unit or Radiology department, you need a flat panel detector you can rely on. Even in the most challenging circumstances. **AeroDR Premium: Built to last.**



Please visit our booth at ECR, 5 - 8 March, Extension Expo A, Booth #3

**KONICA MINOLTA MEDICAL & GRAPHIC IMAGING EUROPE B.V.**

Frankfurtstraat 40 - 1175 RH - Lijnden - The Netherlands - [info-nl@mg.konicaminolta.eu](mailto:info-nl@mg.konicaminolta.eu) - [www.konicaminolta.eu/healthcare](http://www.konicaminolta.eu/healthcare)

Giving Shape to Ideas

DR RETROFIT

Konica Minolta · AeroDR 10" x 12"

**System concept** WLAN  
**Detector** AeroDR CsI FPD 10" x 12" / 25 x 30 cm  
**Pixel size** 175 µm



**Highlights**

- Lightweight, only 1.7 kg
- Durable design
- Quick preview
- Low dose
- Very suitable for orthopaedic, paediatric and neonatal use
- Unique battery technology prevents overheating

Konica Minolta · AeroDR 17" x 17"

**System concept** WLAN  
**Detector** CsI scintillator 17" x 17" / 43 x 43 cm  
**Pixel size** 175 µm

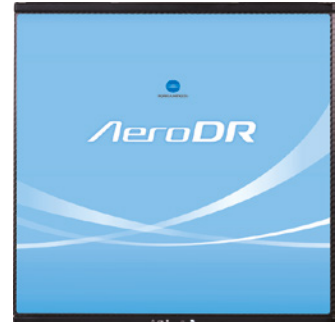

**Highlights**

- Weighs only 3.6 kg
- Wireless
- High DQE CsI detector
- Preview within 2 seconds
- Unique workstation software functions

Konica Minolta · AeroDR 14" x 17"

**System concept** WLAN  
**Detector** CsI scintillator 14" x 17" / 35 x 43 cm  
**Pixel size** 175 µm



**Highlights**

- Unique battery technology
- High quality images at a low dose
- Lightweight, only 2.9 kg, for light handling
- ISO 4090 cassette sized detector for easy integration
- High DQE CsI detector
- 2 second preview

Konica Minolta · AeroDR Premium

**Cassette size** 14" x 17" / 35 x 43 cm  
**Technology** WLAN  
**Pixel size** 175 µm  
**Detector** CsI scintillator



**Highlights**

- Lightweight, only 2.6 kg
- Improved cycle time for increased throughput
- Robust: surface load of 300 kg
- AED – Hybrid detection technology
- Waterproof IPX6, this makes the panel suitable for more extreme environments
- Konica Minolta's unique capacitor technology: quick charging (30 minutes), no overheating

medigration · DR Retrofit-Kit DX | Vision

**Pixel size** 148 µm, 16 bit  
**Detector** a-Si, CsI Pixium, 35 x 43 cm  
**System concept** Wireless, portable detector with WLAN and Battery



**Highlights**

- Your upgrade to fully digital radiography
- Easy integration into an existing X-ray system
  - 100 % touch-capable user interface
  - Cordless and lightweight wireless flat panel detector
  - For the use with mobile X-ray systems
  - Auto-trigger mode (AED function) – No need to synchronise with the generator
  - Excellent image quality through an integrated operating program with HARMONY image processing

PROTEC · RAPIXX 4336 MED

**System concept** Portable, tethered  
**Detector** 43 x 36 cm (ISO 4090 compliant), different scintillator versions  
**Pixel size** e.g. 139 µm



**Highlights**

- 16 bit dynamic range
- Cable connection, lightweight: 3.7 kg
- Predestined for simple retrofitting of existing X-ray units due to dimensions equal to conventional X-ray cassette
- High shock tolerance and water resistant portable flatpanel detector
- Interface box, power supply and CONAXX 2 image acquisition software included in standard delivery – fully DICOM compatible for integration to PACS



## PROTEC · RAPIXX 4343 MED

<b>System concept</b>	Stationary, tethered
<b>Detector</b>	43 x 43 cm, different scintillator versions
<b>Pixel size</b>	e.g. 139 $\mu\text{m}$

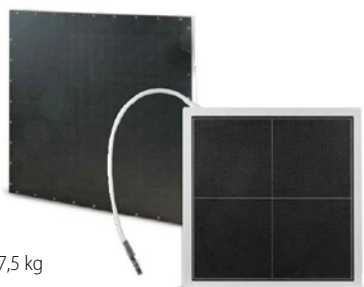
**Highlights**

- 16 bit dynamic range
- Cable connection, weight:  $\geq 7,5$  kg
- Minimal cycle time: 6 s
- For integration and upgrade into existing conventional X-ray units /intended for constant mounting in a X-ray unit
- Interface box, power supply and CONAXX 2 image acquisition software included in standard delivery
- Fully DICOM compatible for integration to PACS

## PROTEC · RAPIXX 4336M WiFi

<b>System concept</b>	Wireless, portable detectors
<b>Detector</b>	43 x 36 cm (ISO 4090 compliant), different scintillator versions
<b>Pixel size</b>	e.g. 139 $\mu\text{m}$

**Highlights**

- Complete set of wireless detector incl. two batteries, interface box, CONAXX 2 DR-software (X-ray generator connection as option)
- Detectors are ISO 4090 compliant, existing bucky can be used for DR retrofit
- Just one flatpanel required for integration into bucky table + wall stand
- 16 bit dynamic range and high DQE for excellent image quality
- Lightweight: 3.3 kg – Preview image



## PROTEC · RAPIXX 4343MF WiFi

<b>System concept</b>	Wireless, portable detector
<b>Detector</b>	43 x 43 cm, Gadoliniumoxide
<b>Pixel size</b>	150 $\mu\text{m}$ - ISS Technology

**Highlights**

- 16 bit dynamic range – images in 3 s result in high productivity
- Simple integration and upgrade into existing conventional X-ray units
- Outstanding flexibility: close at hand, close at patients, just one panel required for bucky table and wall integration
- 43 x 43 cm cassette-sized and light weight WiFi detector for maximum application range
- Fully DICOM compatible for integration to PACS

## Toshiba Electron Tubes &amp; Devices · FDX 3334 RF

<b>System concept</b>	Dynamic flat panel detector
<b>Detector</b>	CsI/Tl, 33 x 34 cm
<b>Pixel size</b>	143 $\mu\text{m}$

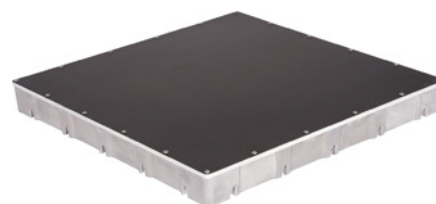
**Highlights**

- Toshiba's proven advanced fine CsI/Tl and direct deposition technologies provide high DQE and excellent resolution.
- The reflective coating in the CsI/Tl screen provides high sensitivity.
- Unique moisture-proof sealing method provides an extremely reliable CsI/Tl screen that is protected from degradation.
- High-speed real-time image processing is used to produce high-quality fluoroscopic images.

## Toshiba Electron Tubes &amp; Devices · FDX 3543 RP

<b>System concept</b>	Portable flat panel detector
<b>Detector</b>	CsI/Tl, 35 x 43 cm
<b>Pixel size</b>	143 $\mu\text{m}$

**Highlights**

- Toshiba's proven advanced fine CsI/Tl and direct deposition technologies provide high DQE and excellent resolution.
- Unique moisture-proof sealing method provides an extremely reliable CsI/Tl screen that is protected from degradation.
- Standard cassette size
- Prompt display of preview/full images and the short cycle time enable fast image acquisition.
- Compact and lightweight for easy handling

## Varian · Nexus Digital Imaging

**Highlights**

- Combines DR and RF capabilities on one platform
- Can be fully integrated with OEM system controls
- Supports all Varian fluoroscopic panels including the new PaxScan 4343CB RF panel
- Designed and developed to optimize image quality and dose efficiency

## DR RETROFIT

### VILLA SISTEMI MEDICALI · VDX 3543PW

<b>System concept</b>	Wireless
<b>Detector</b>	a-Silicon detector with CsI scintillator, 35x43 cm
<b>Pixel size</b>	100 µm

#### Highlights

- Complete cordless positioning freedom, typical of a conventional cassette
- Outstanding pixel size of 100 µm, for the highest image quality
- Auto-triggering mode: the detector automatically synchronizes the acquisition once the X-ray source starts the emission
- System equipped with battery charger and two batteries as standard
- Enhanced productivity with Dicom classes compatibility

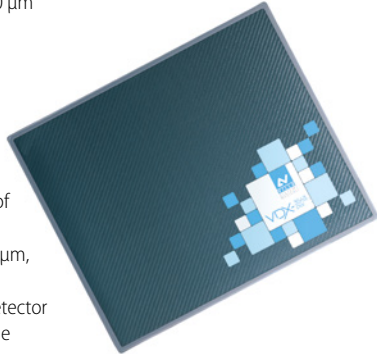

### VILLA SISTEMI MEDICALI · VDX 3543TC

<b>System concept</b>	Wired
<b>Detector</b>	a-Silicon detector with CsI scintillator, 35x43 cm
<b>Pixel size</b>	143 µm

#### Highlights

- Portable lightweight design flat panel fitting into existing bucky without modification
- Increased workflow
- Cost-effective solution, integrating a tether cable for both detector powering and image transferring
- Easy handling from chest stand to bucky table for upright, in-table, lateral and out of bucky exposures
- Enhanced productivity with Dicom classes compatibility

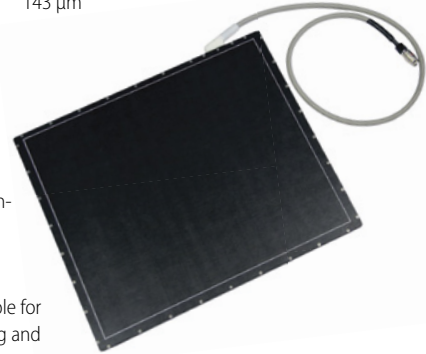

## MOBILE DR

### Agfa · DX-D 100

<b>Motorized</b>	Up to 4 km/h
<b>Technology</b>	Wireless
<b>mAs Range</b>	100 – 500 mA selectable
<b>kV Range</b>	40 to 150 kVp

#### Highlights

- Easy operation, security and precision of all patient-related positioning movements
- MUSICA processing provides superior contrast detail and consistent, exam independent image quality
- NX acquisition workstation offers comprehensive functionality for integrated workflow
- Fully motorized, with superior battery capacity due to split battery concept
- Wireless and tethered detectors available



### FUJIFILM · FDR Go

<b>Power</b>	32 kW
<b>Detector</b>	D-Evo Series (CsI and GOS) 43x43, 35x43, 24x30 cm

#### Highlights

- Lightweight, manoeuvrable and reliable
- Full range of cassette sized FPD can be used anywhere in the hospital
- Easy to use, easy to learn
- Large touchscreen display
- Low tube lock down for easy drive visibility
- Excellent maneuverability for tight rooms
- Xcon connection automates preferred dose settings



### FUJIFILM · FDR Go Flex

<b>Detector</b>	GOS or CSI
<b>Size</b>	35 x 43, 43 x 43 and 24 x 30 cm

#### Highlights

- Fully portable complete wireless solution
- Move instantly between different x-ray and mobile units
- D-EVO Panel, AP Box and Console
- SmartSwitch technology for automatic x-ray detection
- Simple configuration, high portability
- Image preview approx. 2 s
- Full range of cassette sized FPD can be used anywhere in the hospital
- Connect up to 3 DR panels at same time



### GE Healthcare · Optima XR220amx

<b>Power</b>	15 / 30 kW
<b>kV Range</b>	40 – 150
<b>mAs Range</b>	0.2 – 630

#### Highlights

- Advanced digital imaging, powered by Flashpad
- More power in a compact design
- 24/7 availability, no boot-up required
- Automatic charging
- Improved storage





## Konica Minolta · AeroDR Portable Solution

<b>System concept</b>	WLAN
<b>Detector</b>	AeroDR CsI FPD 10" x 12" / 14" x 17" / 17" x 17"
<b>Pixel size</b>	175 µm

**Highlights**

- Easy upgrade of existing portable unit to DR
- Improves your workflow
- Wireless
- Portable CS-7 console for image checking on the spot
- Preview in 3 seconds
- AeroDR panel sharing between portable unit and X-ray room



## Primax · RAYBOW DR

<b>Power</b>	40 kW
<b>Detector</b>	Wireless ultralight generation flat panel
<b>System concept</b>	Battery powered, manual or motorized movement

**Highlights**

- Light weight unit for easier displacement
- Manual or motorized with "dead man" braking system
- Arm rotation around vertical axis
- User friendly touchscreen interface
- Wireless image transmission
- Image export via DICOM CD or USB key
- DICOM 3



## Shimadzu · MobileDaRt Evolution EFX

<b>kV Range</b>	40 – 133 kV
<b>Power</b>	32 kW
<b>Detector</b>	CsI
<b>Pixel size</b>	125 µm

**Highlights**

- New high-sensitive FPD generation
- Dual connectivity of FPD for maximum efficiency
- X-ray images with 2 seconds
- WLAN connectivity
- Easy and advanced operating functions
- mAs range: 0.32 – 320
- Imaging area of 17" x 17" (43 x 42 cm) / 17" x 14" (43 cm x 35 cm) / 14" x 11" (35 x 27 cm)
- Energy saving collimator with a bright irradiation field through LEDs



## Shimadzu · MobileDaRt Evolution EFX – pediatric version

<b>kV Range</b>	40 – 133 kV
<b>Power</b>	32 kW
<b>Detector</b>	CsI
<b>Pixel size</b>	125 µm

**Highlights**

- High sensitive wireless FPD type CXDI-801C (CsI, 14" x 11")
- Handling benefit through easy placement, i. g. in standard incubators
- X-ray images within 2 seconds
- Easy and advanced operating functions
- Energy saving collimator with a bright irradiation field through LEDs
- Fully DICOM compliant
- WLAN connectivity
- mAs range: 0.3 – 320



## Siemens · Mobilett Mira Max

<b>Design</b>	High-end, fully digital mobile X-ray system
<b>Power</b>	35 kW, 450 mA (max)
<b>kV Range</b>	40 – 133

**Highlights**

- Your mobile imaging companion.
- Flexible to meet your challenges – exceptional arm range and precise movements
  - MAX image quality in every situation – low-weight MAX detectors and high imaging power
  - Always ready to assist you – unique charging concept and multiple detector swapping options
  - Ready-to-go design (works from mains power even when batteries are empty)
  - Giraffe design as an option



## STEPHANIX · MOVIX 4 / 8 DReam

<b>Power</b>	4 / 8 kW
<b>Design</b>	Foldable and transportable in a dedicated case
<b>kV Range</b>	Up to 125 kVp

**Highlights**

- Lightweight, less than 100 kg
- Design for in / outdoor operation
- Well-suited for applications at patient bedside, traumatology, paediatrics
- Foldable system easy to store and to transport on field
- Same interface as Stephanix RAD rooms, intuitive with unlimited APR
- Secondary generator control console on monoblock tube head
- Shareable solution



MOBILE DR

STEPHANIX · MOVIX Series DReam

<b>Power</b>	From 20 to 50 kW
<b>Technology</b>	Batteries powered high frequency generator
<b>kV Range</b>	Up to 150 kVp
<b>mAs Range</b>	Up to 500 mAs

**Highlights**

- New ultra-compact and light design
- Motorized up to 5 km/h
- Independent from mains, only for batteries loading
- Telescopic column and arm, offering wide range of movements for easy positioning
- X-ray tube with rotating anode, thin dual focal spots and high heat capacity
- Color LCD touch screen 17"
- Same interface as Stephanix RAD rooms, intuitive with unlimited APR
- Shareable solution



Swissray · ddRCruze Plus

<b>Power</b>	32 / 40 / 50 kW
<b>Detector</b>	a-Si Csl, 35 x 43 cm WiFi, 2.8 kg
<b>Pixel size</b>	148 µm
<b>System concept</b>	2nd workstation

**Highlights**

- Easy to maneuverable motorized mobile X-ray system with variable speed
- 40 to 150 kV and 0.1 to 500 mAs output power
- Convenient and fast image acquisition from the bedside, the OR, ICU or ER room
- Includes second monitor for quick image review
- Built in navigation-camera to overview the way you drive
- Light weight WIFI portable detector delivers superb IQ and maximum workflow efficiency



Technix · TMB 320 DR

<b>System concept</b>	Battery mobile X-ray unit
<b>Power</b>	32 kW
<b>Motorized</b>	Yes
<b>Detector</b>	Tethered or wireless FPD, also in pediatric size

**Highlights**

- Battery-motorized unit for easy maneuvering and bedside positioning
- Battery powered X-ray exposures
- Compact design
- Telescopic arm
- Integrated generator
- Anatomical programs
- 19" touch screen user interface
- Interfaceable with multiple detectors and imaging softwares
- Full DICOM connectivity & WLAN



Technix · TMS 320 / TMS 320 DR

<b>System concept</b>	Mobile X-ray unit
<b>Power</b>	32 kW
<b>Design</b>	Compact design, lightweight
<b>Image system</b>	Available in AR and DR configuration

**Highlights**

- Light and maneuverable unit with small footprint for easy positioning at the patient's bed
- The system is available in two versions: TMS 320: analog version, upgradable on the field to DR configuration TMS 320 DR: digital version, 19" touchscreen user interface, full DICOM connectivity + WLAN, multiple detectors and imaging softwares can be interfaced



Technix · TMS 300 DRH

<b>System concept</b>	Mobile X-ray system for home-based radiology
<b>Power</b>	30 kW
<b>Motorized</b>	Yes
<b>Image system</b>	Analog or digital configuration available

**Highlights**

- 30 kW power for performing any kind of examination
- Small footprint for easy maneuvering
- Motorized crawler tracks for easy transport on stairs
- Sturdy wheels for moving on long distances or uneven surfaces
- High quality DR images on easy-to-use tablet PC
- Several detectors and imaging softwares can be interfaced
- Immediate exam review and transmission to the reference hospital



Toshiba · IME-2000D

**Highlights**

- Mobile X-ray systems are used around hospitals regularly to perform radiography on patients who cannot easily get to an X-ray room.
- Toshiba is proud to introduce a new generation mobile X-ray system equipped with a wireless portable flat panel detector (FPD).



## VILLA SISTEMI MEDICALI · Visitor T30 M-DR

<b>Motorized</b>	Yes
<b>Power</b>	30 kW
<b>Detector</b>	Wired or wireless flat panel detector, 35 x 43 cm
<b>Pixel size</b>	139 µm

**Highlights**

- Motorized DR mobile unit
- Exposures possible without connecting the unit to an external power supply
- Compact structure and flexible positioning
- ± 320° rotating column with telescopic arm
- 35 x 43 cm Flat Panel detector wired or wireless
- Integrated 19" LCD touch screen user interface
- Full DICOM connectivity



## VILLA SISTEMI MEDICALI · Visitor T30 C-DR

<b>Motorized</b>	No
<b>Power</b>	32 kW
<b>Detector</b>	Wired or wireless flat panel detector, 35 x 43 cm
<b>Pixel size</b>	139 µm

**Highlights**

- Compact and lightweight mobile DR unit
- High performance X-ray generator, tubehead with double focal spot (0.8/1.3 mm)
- Large 19" touch screen user interface
- Complete with post-processing tools and DICOM classes compatibility
- Available with wired or wireless flat panel detector



## Wandong · H.F. 30 kW Digital Mobile X-ray Unit – PXD-2000

<b>kV Range</b>	40 ~ 125 kV
<b>mAs Range</b>	1 ~ 320 mAs
<b>Detector</b>	14 x 17"
<b>Power</b>	30 kW

**Highlights**

PXD series mobile DR system is dedicated designed for clinical applications in the operation room, emergency ward, orthopedics and surgical treatment. Outstanding combination of high frequency technology, Ergonomics and compact structure, 17" Touch-Screen control and display, beyonds your expectation. Digital image acquisition, which is DICOM 3.0 compliance, facilitates connection to PACS.



## FLATPANEL FLUORO

## Agfa · DX-D 800

**Highlights**

- Fully robotized R/F solution
- Visual viewfinder for easy, radiation-free positioning
- Combination with ceiling unit is possible

## Canon · DelftDI Uromat RF

<b>Design</b>	Floor mounted RF system
<b>Detector</b>	Canon CXDI Csl RF Flat Panel Detector

**Highlights**

Universal solution for Urology and Fluoroscopy:

- Convenient to work with due to easy ergonomics
- Uncompromised direct digital radiography and fluoroscopy
- Isocentric motorized tilting
- Optimized working position for Urologists and nurses
- High KUB (Kidney Ureter Bladder) FOV
- Highly configurable with modular design
- Multi function footswitch and easy to clean



## Canon · DelftDI D2RS

<b>Design</b>	Remote controlled digital fluoroscopic system
<b>Detector</b>	Canon CXDI Csl RF Flat Panel Detector
<b>Table</b>	-25 / +90 degrees

**Highlights**

- Unrivalled 3-in-1 solution for radiography and fluoroscopy
- Uncompromised direct digital radiography and fluoroscopy
- Motorized auto-positioning, dose reduction features
- Head-to-toe patient coverage
- "Smart access" table position for easy patient transfer
- Variable table height, variable SID for all clinical examinations (max. 180 cm)
- Customizable pediatric protocols



## FLATPANEL FLUORO

### DMS / APELEM · Optima

<b>Design</b>	Digital Remote-controlled R/F system fully-motorized
<b>Detector</b>	43 x 43 cm, 148 µm, a-Si / CsI
<b>Power</b>	50 / 65 / 80 kW

#### Highlights

The Optima is the latest table designed and developed by DMS APELEM.

This solution is designed to be effective and adapt to any type of budget.

- SID up to 180 cm
- Fully motorized tube rotation
- Patient coverage 195 cm with 2 ways and >270 cm with 4-way table top
- +90° / -30° motorized tilting table, this table performs all types of R/F examinations
- Innovative tilt / shift movement allowing 79 cm fixed height



### DMS / APELEM · Platinum DRF

<b>Design</b>	Digital Remote controlled fully motorized
<b>Detector</b>	43 x 43 cm, 148 µm, a-Si / CsI
<b>Power</b>	50 / 65 / 80 / 100 kW
<b>Resolution</b>	2,880 x 2,880 pixels, 3.4 lp/mm

#### Highlights

- True full access all around the table top for easy patient transfer
- 48 cm lowest table height for optimal patient loading
- Excellent image quality with lowest possible dose (SID 180 cm)
- All movements are motorized and independent for maximum configuration versatility
- Innovative control system based on PC server technology
- Constant improvement with new innovations every year



### GMM · OPERA Swing – Multifunctional system with DFPD

<b>Detector</b>	Amorphous silicon
<b>Pixel size</b>	148 µm
<b>Size</b>	43 x 43 cm

#### Highlights

- Highly integrated all-in-one system for enhanced examinations in digital RAD and Fluoro procedures
- Extraordinary user-friendliness and operational efficiency in any application (E.R., digital angiography, Tomosynthesis, column-lower limbs Stitching, ect.)
- Easy execution of lateral projections and oblique incidences also on stretchers
- Exams on tabletop or in direct contact with the detector



### GMM · OPERA T90 Sharp – Remote-controlled system with DFPD

<b>Detector</b>	Amorphous silicon
<b>Resolution</b>	148 µm
<b>Size</b>	43 x 43 cm

#### Highlights

- Wide series of R/F remote-controlled tables with digital flat panel detector
- User-friendliness and enhanced examinations in E.R., trauma, thorax and lungs, skeleton, gastroenterology, urology, digital angiography, etc.
- Extraordinarily low distance of the elevating tabletop from the floor of only 50 cm
- Intelligent user interface integrating all the controls in a unique advanced touch screen



### Mecall · EIDOS RF 439 – 90 / 90 Remote-controlled table

<b>Detector</b>	Amorphous silicon
<b>Resolution</b>	148 µm
<b>Size</b>	43 x 43 cm; 35 x 43 cm WiFi; 24 x 30 cm WiFi

#### Highlights

- 90 / 90 RF system with 43 x 43 cm flat panel and exclusive auto-focusing device
- Single end suspended carbon-fibre patient tabletop for total accessibility from any side
- Elevating tabletop with 50 cm minimum distance from the floor
- Full-length patient examination in both vertical and horizontal position
- Full integration with optional ceiling suspension and Wi-Fi detector



### Primax · NIKAIÁ DRF

<b>Detector</b>	43 x 43 cm a-Si dynamic flat panel
<b>Power</b>	Up to 80 kW
<b>Design</b>	+90° / -90° Digital remote controlled tilting table

#### Highlights

- 2 in 1 system digital radiology and fluoroscopy
- Patient accessibility from 4 sides
- Carbon fibre tabletop
- Full patient coverage without table longitudinal movement
- Extractable Auto focus grid (patented)
- Automatic stitching function for spine and lower limbs in real time





Shimadzu · Sonialvision G4

<b>Power</b>	80 kW / 65 kW
<b>Detector</b>	Dynamic flat panel detector (CsI), 17" x 17" (43 x 43 cm), 3.6 Lp / mm
<b>Pixel size</b>	139 µm



**Highlights**

- Premium R/F system with dynamic flat panel detector
- 2nd tube option for multi purpose room solution
- SUREngine technology: realtime image enhancement processing
- Digital tomosynthesis for general radiography
- Slot radiography
- Angiography option
- Comprehensive dose management package

Shimadzu · Flexavision F3

<b>Power</b>	50 / 80 kW
<b>Detector</b>	Flat panel detector (a-Si), 14" x 17" (35 x 43 cm)
<b>Pixel size</b>	160 µm



**Highlights**

- Portable dynamic FPD for various studies from head to toe
- Outstanding digital image quality
- Great flexibility through smart modular technology
- Intensive patient care

Siemens · Artis zee multi-purpose

<b>Design</b>	Multi-purpose flat detector fluor and angio
<b>Detector</b>	2 k a-Si with CsI Scintillator
<b>Resolution</b>	1,920 x 2,480 pixel, 3.25 Lp / mm



**Highlights**

- 3D-applications
- New multi-host imaging system
- Right or left side suspension for endoscopic applications
- 2 k-acquisition available
- New ergonomic system controls for smooth table-side operation
- Undertable / overtable positioning
- Full in-room-control (on trolley)
- Remote controls for room operation available

Siemens · Luminos dRF Max

<b>Design</b>	Remote controlled fluoroscopy & radiography system
<b>Detector</b>	a-Si / CsI
<b>Size</b>	43 x 43 cm



**Highlights**

- Taking 2-in-1 to the MAX in radiography and fluoroscopy
- The first 2-in-1 system for:
  - Safer use – with a 48 cm minimum table height, full patient access from all sides and SmartTouch touch-sensitive joysticks
  - Sharper imaging – MAX image quality with a large 43 x 43 cm MAX dynamic detector
  - Stronger synergies – with MAXswap and 2-in-1 efficiency in radiography and fluoroscopy

Siemens · Luminos Agile Max

<b>Design</b>	Patient-side controlled R/F system
<b>Detector</b>	a-Si / CsI
<b>Size</b>	43 x 43 cm



**Highlights**

- A more RADical way in fluoroscopy.
- The first patient-side system to offer:
  - Safer use with a height adjustable table
  - Sharper imaging with a large MAX dynamic flat detector
  - Stronger synergies with MAX dual use in radiography and fluoroscopy
- Ysio Max options:
  - Ceiling-suspended tube with bucky tracking
  - MAX wi-D and MAX mini detectors with MAXswap
  - SmartOrtho – long leg and full spine imaging

Siemens · Luminos Fusion

<b>Design</b>	Remote-controlled R/F system
<b>Detector</b>	a-Si / CsI
<b>Size</b>	43 x 43 cm



**Highlights**

- The 2-in-1 system that fits your needs and fits your budget
- MAX image quality in radiography and fluoroscopy (FD version only)
- Technology from high-end Max systems
- Easy access for fast and easy patient positioning
- Touch-sensitive joysticks
- Outstanding dose reduction with CARE
- Wide range of options and applications
- 2-in-1 efficiency – flexibility and high utilization saves space and costs

FLATPANEL FLUORO

STEPHANIX · D<sup>2</sup>RS

**Technology** Dynamic flat panel detector  
**System concept** High-end remote controlled table  
**Design** Compact, lightweight and robust  
**Motorized** Automatic positioning, collimation, filtration, parameters

**Highlights**

- Unmatched patient coverage
- Patient weight up to 310 kg
- Autopositioning regarding each protocol
- Smart access for secure patient transfer
- Dose optimization with virtual collimation, additional filtration, video camera...
- Intuitive user interface
- Wireless remote
- Secondary console
- DSA



- Stitching
- Tomosynthesis
- Second tubestand and additional detectors

STEPHANIX · Evidence DReam

**System concept** 3-in-1 cost-effective remote controlled table  
**Technology** Indirect conversion Flat Panel Detectors  
**Detector** Fixed and wireless solutions

**Highlights**

- Head-to-toe exploration
- Smart 8 ways tabletop travel for easy patient displacement
- Column angulation ±40° on the whole table's length
- Tomography
- Fixed or variable height
- Radiation-free for patient positioning with video camera
- Stitching
- Second tubestand and additional detectors



**Buy & sell used equipment on**

**DOTmed<sup>®</sup>**  
[www.dotmed.com](http://www.dotmed.com)  
*Over 400,000 listings*  
*Over 20,000 daily visitors*

Toshiba · ULTIMAX-i

**Power** 80 kW  
**Detector** 3 k x 3 k high resolution 43 x 43 cm flat panel detector  
**Pixel size** 148 µm

**Highlights**

- The Ultimax-i system provides a multipurpose digital X-ray system with a tilting C-arm table for multipurpose diagnostic applications and interventional radiology.
- An additional ceiling mounted X-ray tube can be combined. This system can be used for a wide variety of clinical applications.



Toshiba · Xantara



**Highlights**

- The Xantara system was designed to provide maximum flexibility for all types of exam rooms and for all types of exams.
- From the clean, sleek lines of the design, to the simplified all-in-one control console, to the mechanical ergonomics and elegance, the Xantara is the remote controlled table solution like you've never seen before.

VILLA SISTEMI MEDICALI · Apollo Open DRF

**Power** 65 – 80 kW  
**Detector** Dynamic flat panel detector, 43 x 43 cm  
**Pixel size** 148 µm

**Highlights**

- Premium digital remote controlled system with OPEN tabletop, allowing 4-side access to the patient
- Standard carbon fiber tabletop
- Full patient coverage by moving only the tube-receptor assembly, without patient repositioning
- Standard Auto Grid Selection function, automatic Stitching option
- Oblique projections at table edges and bar-less tomography
- 180 cm Source to Image Distance







European Congress of Radiology

# ECR 2015

*Vienna*  
March 4–8

*Radiology without borders*

Colour Outside the Lines

[ecr.myESR.org](http://ecr.myESR.org)



FLATPANEL FLUORO

VILLA SISTEMI MEDICALI · Apollo DRF

**Power** 65 – 80 kW  
**Detector** Dynamic flat panel detector, 43x43 cm  
**Pixel size** 148 µm

**Highlights**

- Premium digital remote controlled system for full clinical coverage in R/F applications
- Full patient coverage by moving only the tube-receptor assembly, without patient repositioning
- Standard Auto Grid Selection function and automatic Stitching option
- Oblique projections at table edges and bar-less tomography
- 180 cm Source to Image Distance (SID)



VILLA SISTEMI MEDICALI · Apollo EZ DRF

**Power** 65 – 80 kW  
**Detector** Dynamic flat panel detector, 43x43 cm  
**Pixel size** 148 µm

**Highlights**

- Compact and cost-effective digital system for all the needs of radiographic and R/F imaging
- Available with 2-way or 4-way flat tabletop, plastic or carbon-fiber
- Standard Auto Grid Selection function and automatic Stitching option
- Variable Source to Image Distance (SID): up to 180 cm
- Oblique projections at table edges and bar-less tomography

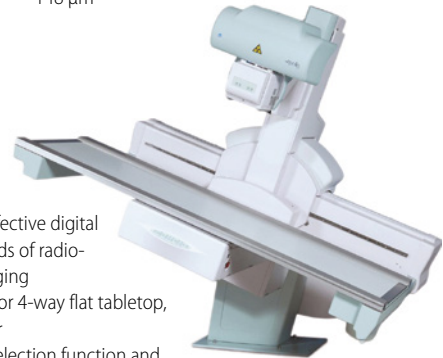

Wandong · DRF Series

**System concept** 80 kW digital radiography and fluoroscopy system  
**Detector** 40x30 cm FPD  
**Pixel size** 194 µm

**Highlights**

- Advanced FPD detector
- High frequency 80 kW generator
- Large size detector brings larger display area
- Clear dynamic image without distortion
- High acquisition rate
- Variable SID
- Available for both digital radiography and fluoroscopy
- Powerful image processing function



Xingyaoyi (XGY) · Gemini-DRF-4343

**mAs Range** Photography electric current: 10 ~ 800 mA  
 Fluoroscopy electric current: 0.5 ~ 6 mA  
**Image system** Photography voltage: 40 ~ 150 kV  
 Fluoroscopy voltage: 40 ~ 125 kV  
**Pixel size** 148x148 µm

**Highlights**

- XGY-Gemini-DRF-4343 goes beyond the separation between radiography and fluoroscopy
- The large 43x43cm active area and the image resolution more than 3.5 lp/mm
- One room, one detector and one imaging platform an extensive range of applications that typically require multiple devices when based on legacy equipment
- Operation System: Microsoft Windows XP / Dual-core processor  
 Memory ≥ 2GB / Monitor: 1,024x768 pixel



ACCESSORIES / COMPLEMENTARY SYSTEMS

DMS / APELEM · Stratos

**Technology** Digital fast beam, the fastest on the market

**Highlights**

- The complete solution for an optimal fracture risk diagnosis in routine
- Full options including paediatric and orthopedic software
- Exams can be performed in only 60 seconds per site
- Powerful easy-to-use software
- Compatible with 3D-DXA technology that allows cortical thickness analysis and volumic BMD
- Body composition application for weight management, tracking fat and lean tissue



DMS / APELEM · Stratos DR

**Technology** 2D-Fan Beam  
**Detector** 256 elements, highest image resolution

**Highlights**

- Complete solution for an optimal fracture risk diagnosis
- Full options including paediatric and orthopedic software
- Exams can be performed in only 30 seconds in routine mode
- Powerful easy-to-use software
- Compatible with 3D-DXA technology that allows cortical thickness analysis and volumic BMD
- Body composition application for weight management, tracking fat and lean tissue





DMS / APELEM · 3D DXA

**Technology**

Breakthrough Technology to complete fracture risk assessment

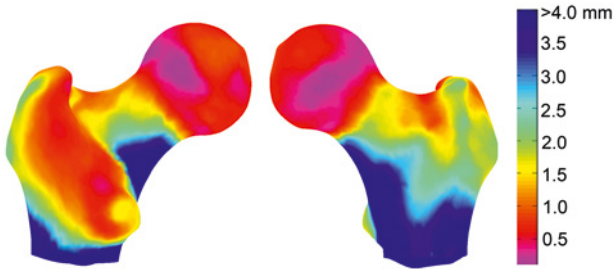

**Highlights**

3D-DXA is a 3D modelization of the hip performed with DMS DXA systems. Detailing information such as:

- Color mapping of cortical thickness
- Mean cortical thickness on relevant regions

- vBMD (volumic BMD) trabecular, cortical and global (total femur, femoral neck, intertrochanteric, greater trochanter)
- Femoral Neck Axis Length in 3D
- Femoral Neck Shaft Angle in 3D

Dunlee · Smit Röntgen Grids



**Highlights**

- Standard grids, mammography grids and grids designed for special applications
- Low absorption because of the fiber interspacer
- Higher SNR with detectors in digital applications and a significant dose advantage over aluminum interspaced grids
- Any focal distance between 70 cm and 300 cm – Less weight than aluminum interspaced grids, up to 1 / 3

Dunlee · Radiographic Tubes



**Highlights**

- Tubes for RAD, CV and RF
- Tubes from Dunlee offer optimal performance, high-heat dissipation capabilities, and unique ball-bearing construction. Most new tube units include a trunnion ring assembly.

Hitachi · Aloka AOS-100E EggQus

**Size** 32x38x18 cm (WxDxH); weight ~4 kg  
**Measurement item** (SOS) Speed of sound  
**Power** Battery / AC adaptor



**Highlights**

- Designed for maximum portability
- Compact and handy compared to conventional quantitative ultrasound systems
- The large integral handle facilitates in-hospital rounds and house visits
- Powered by rechargeable batteries, AC-adaptor available for long continuous measurement
- Measurement using Speed of Sound
- Approx. Three Seconds Measurement Time (measurement performed on a PC)

Hitachi · Aloka AOS-100SA

**Size** 32x53x27cm (WxDxH); weight ~ 14kg  
**Measurement item** OSI (Osteo Sono Assessment Index), BUA (Broadband Ultrasound Attenuation), TI (Transmission Index), SOS (Speed of Sound)  
**Power** AC



**Highlights**

- Reliability under all circumstances – from routine checkup to screening of the elderly and children
- Color touch panel LCD, printer for direct measurement output, data memory, all included in single unit
- OSI (Osteo Sono Assessment Index) works as a comprehensive index reflecting Speed of Sound and wave band
- Short measurement time (~ 2 seconds) for rapid handling of elderly and other patients

Hologic · Discovery DEXA (fan beam) Bone Densitometer



**Highlights**

- Hologic Discovery DXA system is the key to early osteoporosis detection.
- Exceptional precision and accuracy
  - High Resolution Digital Detector Array to improve fracture detection and to visualize abdominal aortic calcifications
  - Discovery imaging technology captures the hip and spine with as fast as 10-second regional scanning time
  - Exclusive design utilizes a high resolution detector array paired with true fan-beam linear acquisition geometry
  - Continuous automatic calibration

ACCESSORIES / COMPLEMENTARY SYSTEMS

Hologic · Horizon DEXA (fan beam) Bone Densitometer

**Highlights**

- The Horizon bone densitometer platform for osteoporosis, cardiovascular disease, and obesity assessment is designed to include the latest in technical capabilities and workflow efficiencies.
- 10 – 15-second femur scan to visualize potential atypical femur fractures
  - High Resolution Ceramic Digital Detector Array – Ultrafast, high output, low noise ceramic detectors that provide better bone mapping and image
  - High Frequency Pulsing Power Supply and full size X-ray tube
  - A Dynamic Calibration System for greater long-term measurement stability



I.A.E. · RTC 600

**Highlights**

- Rotating anode graphite X-ray tube, specifically designed for remote controlled table and digital systems
- High anode heat storage for repeated loading
- Enhanced anode heat dissipation, provided by high emittance coating and target design
- Severe tests during conditioning assure reliable performances
- Ground glass window for consistent HVL
- Variety of housings allows flexible systems configurations



Konica Minolta · AeroDR Auto-Stitching System

**Detector**

AeroDR 14" x 17"

**Highlights**

- Unique and easy to use
- Can be used with any X-ray system
- AeroDR Csl FPD 14" x 17"
- Effective image size after stitching: up to 35 x 120 cm
- No markers required



Toshiba Electron Tubes & Devices · 1M-pixel CCD camera VP-34509

**Highlights**

- Superior image quality
  - Pixels 1,024 x 1,024
  - Flame rate 30 fps
  - Dynamic range 60 dB
- Optimal for digital fluoroscopy
  - Can be used in combination with TOSHIBA image intensifiers
- Simple capture system
  - Gigabit Ethernet interface
- Environmentally friendly
  - Compliant with the RoHS directive
  - Free from hazardous substances such as hexavalent chromium and cadmium



Toshiba Electron Tubes & Devices · XRR-4631G

<b>Size</b>	0.6 / 1.2
<b>Power</b>	40 kW / 100 kW
<b>Capacity</b>	400 kHU (Anode heat capacity) 1,200W (Anode heat dissipation)

**Highlights**

- 4" ROTANODE X-ray tube assembly for RF systems
- 20% smaller housing than previous model
- Can be used as a replacement part for similar models
- High power input: 100 kW / 40 kW (0.1 s)
- High cooling rate provided by housing



Toshiba Electron Tubes & Devices · XRR-3331 X

<b>Size</b>	0.6 / 1.2
<b>Power</b>	27 kW / 75 kW
<b>Capacity</b>	300 kHU (Anode heat capacity) 870W (Anode heat dissipation)

**Highlights**

- 3" ROTANODE X-ray tube assembly for RF systems.
- High power input: 75 kW / 27 kW (0.1 s)
- Advanced simulation technologies are used in development and manufacture to produce tubes with excellent performance and reliability and a long tube life.



# Molecular Imaging

SPECT  
SPECT-CT  
PET-CT  
PEM  
Accessories /  
Complementary Systems



GE Healthcare



**Medicor**

**SIEMENS**

SPECT

**GE Healthcare · Brivo NM 615**

<b>System sensitivity</b>	270 cpm / $\mu$ Ci
<b>Energy resolution (NEMA)</b>	9.8 %
<b>Field of View</b>	540 x 400 mm



**Highlights**

- Excellent image quality based on advanced Elite NXT detectors
- Exceptional productivity enabled through evolution 1/2 time planar and SPECT scans options
- Fast and flexible robotic gantry motions for exceptional clinical versatility
- Investment protection enabled through upgradeability path to Discovery NM 630 and even to SPECT/CT: Optima NM/CT 640 or Discovery NM/CT 670

**GE Healthcare · Discovery NM 530c**

<b>System sensitivity</b>	1,300 cpm / $\mu$ Ci
<b>Energy resolution (NEMA)</b>	6.2 %
<b>Field of View</b>	–



**Highlights**

Alcyone Technology:

- Solid State CZT Detectors
- Pin hole focused collimation
- Stationary acquisition
- 3D reconstruction
- Higher sensitivity; Flexibility to manage dose more efficiently
- Scans as fast as 3 minutes

**GE Healthcare · Discovery NM 630**

<b>System sensitivity</b>	270 cpm / $\mu$ Ci
<b>Energy resolution (NEMA)</b>	9.8 %
<b>Field of View</b>	540 x 400 mm



**Highlights**

Premium, all-purpose, dual detector free geometry integrated nuclear imaging system, featuring:

- Excellent image quality based on advanced Elite NXT detectors
- Slim-profile, wide-bore, fast and flexible robotic gantry design for exceptional clinical versatility
- Upgradeability path to SPECT/CT: Optima NM/CT 640 or Discovery NM/CT 670 (subject to appropriate site preparation)

**GE Healthcare · Discovery NM 750b**

<b>System sensitivity</b>	–
<b>Energy resolution (NEMA)</b>	6.5 %
<b>Field of View</b>	160 x 240 mm



**Highlights**

CZT based gamma camera dedicated to imaging of breast cancer as adjunct to mammography

- High-resolution, direct conversion, solid-state CZT semiconductor detectors
- For dense breast, MBI technology outperformed mammography in early detection and in finding more cancers
- Tracers with indication for breast cancer diagnosis
- Powered by Xeleris 3 advanced tools and optional packages

**Siemens · Symbia Evo Excel**

<b>System sensitivity</b>	202 cpm / $\mu$ Ci (LEHR 3/8" at 10 cm)
<b>Intrinsic spatial resolution</b>	$\leq$ 3.8 mm FWHM in CFOV
<b>Field of View</b>	533 x 387 mm

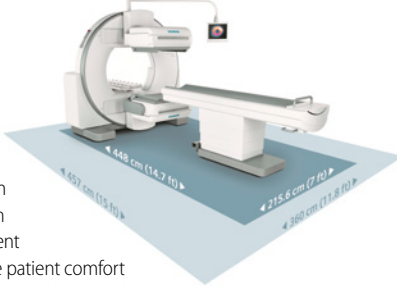

**Highlights**

- Smallest room size in its class, reducing costs associated with room remodeling and expansion
- Ability to image every patient (up to 227 kg) and improve patient comfort with a larger bore; a highcapacity, low-height patient bed; and hospital bed imaging capabilities
- Industry-leading image quality delivers accurate and reproducible clinical information to support physicians' diagnostic confidence (Based on competitive literature available at time of publication. Data on file.)

**Siemens · Siemens Symbia S**

<b>System sensitivity</b>	202 cpm / $\mu$ Ci (LEHR 3/8" at 10 cm)
<b>Intrinsic spatial resolution</b>	$\leq$ 3.8 mm FWHM in CFOV
<b>Field of View</b>	533 x 387 mm



**Highlights**

- Siemens AUTOFORM, a unique collimator design that allows for up to 26 % higher sensitivity (Based on competitive literature available at time of publication. Data on file.)
- IQ-SPECT ultra-fast cardiac solution provides a complete cardiac work-up in only 5 minutes
- Automated Quality Control saves time and reduces radiation exposure
- Automated Collimator Changer increases workflow efficiency



SPECT-CT

GE Healthcare · Discovery NM/CT 670

**System sensitivity** 270 cpm/μCi  
**Energy resolution (NEMA)** 9.8%  
**Field of View** 540x400 mm



**Highlights**

All great capabilities of Discovery NM 630 plus:

- Full diagnostic BrightSpeed Elite 8 or 16 slice CT for localization and diagnostic CT studies
- Designed to enable 16 min Whole body & Hybrid SPECT/CT scan
- CT Dose management with ASiR
- IQE3 enables more coverage w/ fewer artifacts
- CT Calcium Scoring and Angio functionality
- Expanded NM dose management Evolution Toolkit

GE Healthcare · Optima NM/CT 640

**System sensitivity** 270 cpm/μCi  
**Energy resolution (NEMA)** 9.8%  
**Field of View** 540x400 mm



**Highlights**

All great capabilities of Discovery NM 630 plus:

- SPECT/CT low-dose imaging without compromise
- Low total cost of ownership, with a technology continuum for upgradability
- Acquisition speed that drives efficiency
- Designed to enable 16 min Whole body + Hybrid SPECT/CT scan
- Simplified hybrid scan setup

Discover the  
**POWER**  
 of **CBCT**

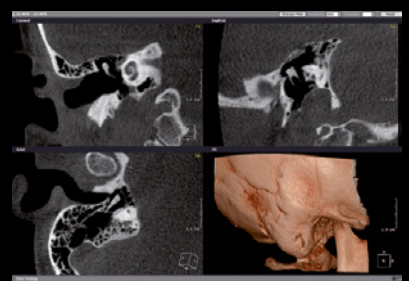
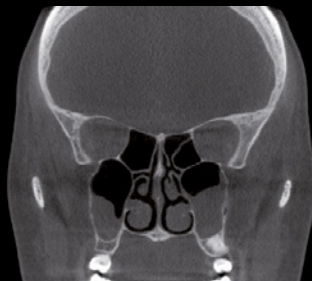

**SOREDEX**  
[www.soredex.com](http://www.soredex.com)

See you at ECR, Vienna! Hall Expo C, Booth nr. 313

SPECT-CT

**Siemens · Symbia Intevo**

<b>System sensitivity</b>	202 cpm/μCi (LEHR 3/8" at 10 cm)
<b>Intrinsic spatial resolution</b>	≤ 3.8 mm FWHM in CFOV
<b>Field of View</b>	533 x 387 mm

**Highlights**

- Higher image resolution enables physicians to distinguish between degenerative disease and cancer
- The first and only system offering accurate and reproducible SPECT quantification
- Up to 68 % lower CT dose with CARE Dose4D and up to 80 % lower injected dose with IQ-SPECT to reduce patient radiation risk  
(Based on competitive literature available at time of publication. Data on file.)
- Productivity tools and IQ-SPECT save time and can double patient throughput



**Siemens · Symbia Intevo Excel**

<b>System sensitivity</b>	202 cpm/μCi (LEHR 3/8" at 10 cm)
<b>Intrinsic spatial resolution</b>	≤ 3.8 mm FWHM in CFOV
<b>Field of View</b>	533 x 387 mm

**Highlights**

- SPECT with integrated CT for attenuation correction and anatomical localization
- Flash 3D enables up to 24 % higher reconstructed resolution than conventional SPECT 3D iterative reconstruction  
(Based on competitive literature available at time of publication. Data on file.)
- Largest CT field-of-view enables physicians to more accurately localize lesions
- IQ-SPECT enables up to 80 % lower injected dose or shorter imaging time, increasing patient comfort and satisfaction



**Siemens · Symbia T Series**

<b>System sensitivity</b>	202 cpm/μCi (LEHR 3/8" at 10 cm)
<b>Intrinsic spatial resolution</b>	≤ 3.8 mm FWHM in CFOV
<b>Field of View</b>	533 x 387 mm

**Highlights**

- SPECT/CT with integrated diagnostic stand-alone CT
- IQ-SPECT ultra-fast cardiac solution provides a complete cardiac work-up in only 5 minutes
- Reduce exposure and improve workflow with Automated Quality Control and Automated Collimator Exchange
- Offers 2-, 6- or 16-slice spiral CT



**GE Healthcare · Discovery PET/CT 710**

<b>Resolution</b>	2 mm (w.SharpIR)
<b>Sensitivity</b>	7.5 cps/kBq
<b>Field of View</b>	70 cm

**Highlights**

Leading edge technology for advanced applications and demanding academic practices

- Designed for short-lived tracers – high count rate capability
- Treatment assessment and quantitative consistency with Q.Suite
- VUE Point HD – 3D iterative reconstruction with Time of flight capability
- Optimized for complex research protocols
- CT flexibility
- LBS detector design



**GE Healthcare · Discovery PET/CT 610**

<b>Resolution</b>	2 mm (w.SharpIR)
<b>Sensitivity</b>	10 cps/kBq
<b>Field of View</b>	70 cm

**Highlights**

PET/CT solution with all-around performances in oncology, cardiology and neurology

- Low dose and fast scans, high sensitivity, optimized for F18
- Treatment assessment and quantitative consistency with Q.Suite
- Advanced treatment planning and motion management
- Q.Core for dedicated PET reconstruction
- Clinical research capability
- CT flexibility
- BGO detector design



**Buy & sell used equipment on**

**DOTmed®**

[www.dotmed.com](http://www.dotmed.com)

**Over 400,000 listings**

**Over 20,000 daily visitors**

Siemens · Biograph mCT

**Gantry Opening** 78 cm  
**Volumetric Resolution** 95 mm<sup>3</sup>  
**Field of View** Up to 221 mm (axial)

**Highlights**

- Molecular CT – quantification redefined
- Increased confidence in quantitative results with automatic daily quality control with normalization
- Superb visualization, particularly of small tumors with industry-leading volumetric resolution of 95 mm<sup>3</sup>  
 (Based on volumetric resolution available in competitive literature for systems greater than 70 cm bore size. Data on file.)
- Whole-body PET scans in only 5 minutes or with 5 mCi injected dose – with TrueV
- Increase revenue with a 78 cm bore for radiation therapy planning



Siemens · Biograph mCT Flow

**Gantry Opening** 78 cm  
**Volumetric Resolution** 95 mm<sup>3</sup>  
**Field of View** Up to 221 mm (axial)

**Highlights**

- Only PET / CT where planning and scanning are based on a single continuous table motion
- Finest detail in every organ with industry's highest resolution of 95 mm<sup>3</sup>  
 (Based on volumetric resolution available in competitive literature for systems greater than 70 cm bore size. Data on file.)
- Up to 25 % less scan time per patient with single scan protocol using motion management
- Whole-body PET scan in 5 minutes – with TrueV
- Accurate and reproducible quantification in all dimensions enables a more confident interpretation



Siemens · Biograph mCT 20 Excel

**Gantry Opening** 78 cm  
**Volumetric Resolution** 95 mm<sup>3</sup>  
**Field of View** Up to 164 mm (axial)

**Highlights**

- Affordable performance
- Industry-leading PET resolution of 95 mm<sup>3</sup> for visualization of small tumors  
 (Based on volumetric resolution available in competitive literature for systems greater than 70 cm bore size. Data on file.)
- Accurate SUV quantification and full HD lesion detection with frozen-motion images
- One-click gating integrated in daily routine
- Image virtually all patients (up to 227 kg) with unique 78 cm wide bore and short tunnel
- Increase referral base for bariatric and radiation therapy patients

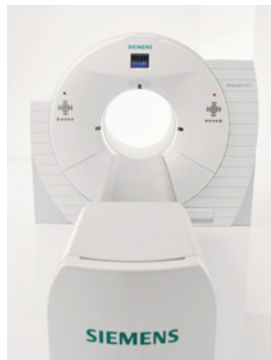

PEM

Medicor · NAVISCAN PEM

**System sensitivity** 1.6 cps / kBq  
**Energy resolution (NEMA)** 13 %  
**Field of View** 23.2 cm axial

**Highlights**

PET scanner specifically optimized to provide metabolic visualization of abnormal breast tissue. The scanner works as an adjunct to conventional imaging procedures to detect, stage and manage breast cancer. Through a combination of gentle immobilization, advanced photonics and image processing, Positron Emission Mammography (PEM) allows to enhance early detection by identifying lesions smaller than 1.6 mm.



ACCESSORIES / COMPLEMENTARY SYSTEMS

Alliance Medical · Flexible diagnostic imaging services

**Highlights**

- Static diagnostic imaging centers MRI, CT, PET, PET / CT, Cath Lab
- Interim services for bridging downtimes
- Regular "routing" services



Alliance Medical · Modular building solutions

**Highlights**

Engineering, rental, sale of modular buildings MRI, CT, PET, PET / CT including or excluding diagnostic equipment.



# Displays / Printers

Displays – Mammo  
Displays – Color  
Displays – Grayscale  
Displays – Clinical Review  
Displays – Large Format  
Printers  
CD- / DVD-Robot  
Accessories /  
Complementary Systems

**AGFA**   
HealthCare



 **DOMÉ**  
by NDSSi



**FUJIFILM**



  
The Digital Company  
ein Unternehmen der bender gruppe



**SECTRA**

**NEC**

**TOTOKU**



DISPLAYS – MAMMO

Barco · Mammo Tomosynthesis 5MP

**Panel size** 21"  
**Resolution** 5 MP (2,048 x 2,560)

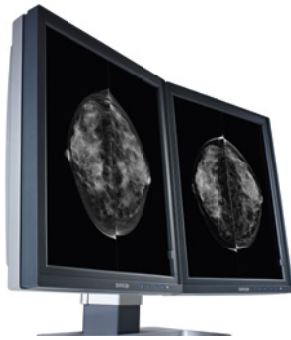

**Highlights**

- Approved for digital mammography and breast tomosynthesis
- Facilitates multi-frame breast imaging studies without blurring
- 4 x brightness boost for inspection of subtle details or comparison with film-based priors
- Ultra-precise image representations and elimination of quantization artifacts
- Free MediCal QAWeb licence for automated QA & calibration
- 5-year warranty including front sensor

Barco · Coronis 5MP Mammo

**Pixel matrix** 5 MP  
**Panel size** 21"  
**Resolution** 5 MP (2,048 x 2,560)  
**Max. luminance** 1,600 / 2,100 cd/m<sup>2</sup>

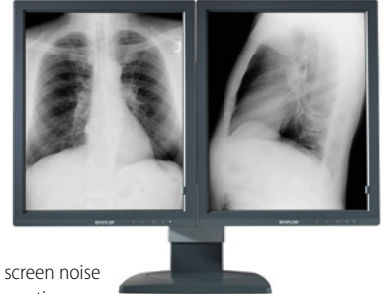

**Highlights**

- Grayscale IPS Wideview LCD
- High resolution, high contrast and perfect geometry
- Pixel-perfect diagnostic precision without disturbing screen noise
- Uniform luminance across the entire screen center to corner
- Free MediCal QAWeb licence for automated QA & calibration
- 5-year warranty including front sensor

EIZO · RadiForce GX540

**Pixel matrix** 5 MP  
**Panel size** 21.3"  
**Max. luminance** 1,200 cd/m<sup>2</sup>

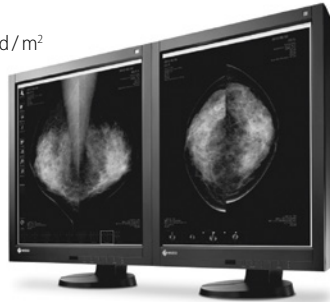

**Highlights**

- Consistency with DICOM part 14 calibration
- Easy calibration with integrated front sensor
- Quick brightness stabilization for instant viewing
- Brightness uniformity for a steadier image across the screen
- Light sensor for measuring the ambient light conditions of the working environment
- Presence sensor for immediately activating the screen upon your return

NDSi · Dome E5

**Pixel matrix** 5 MP  
**Panel size** 21.3"  
**Max. luminance** 1,100 cd/m<sup>2</sup>



**Highlights**

- 5 MP Diagnostic Display built for the most demanding diagnostic applications, including mammography, CR and DR.
- RightLight-guaranteed lifetime DICOM calibration
- Uncompromised image quality
- Diamond standard for high-end radiology and mammography
- Fanless, lightweight, low-power design
- High-bright 10-bit grayscale display
- DICOM calibrated for life. No additional field calibration is ever necessary

NEC · Grayscale Diagnostic Display MD211G5

**Pixel matrix** 5 MP  
**Panel size** 21"  
**Resolution** 2,048 x 2,560

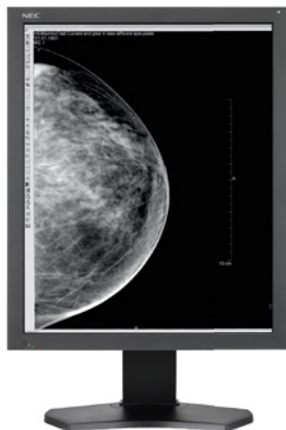

**Highlights**

- The NEC MD211G5 flat panel display systems are suitable for displaying and viewing of digital images for diagnosis by trained physicians. Applications include diagnostics image reporting in radiography and mammography.
- Up to 1,024 simultaneous shades of grey – out of a palette of 12,277
  - Front Sensor and LED backlight system – for long lasting stable luminance

**Buy & sell used equipment on**



[www.dotmed.com](http://www.dotmed.com)

**Over 400,000 listings**  
**Over 20,000 daily visitors**



# Calibration

## Important facts to know

### What makes Dome displays unique:

#### Lifetime Calibration

- Dome displays are fully factory characterized using a NIST-traceable photometer and true DICOM test patterns, providing uncompromising accuracy.
- The characterization data is stored in the panel and allows the display to remain in perfect DICOM calibration for life.
- No additional field calibration is ever needed!

#### Hospital benefits:

##### 1. Ergonomic solution

- With Dome displays you can simply open the box, plug it in, and you're ready!
- No irritating noise from fans (for active cooling).
- No reflective material and no front "power-on" LED shining directly in the eyes of the radiologist.

### Calibration – when, where and how

DICOM calibration is one of the defining characteristics of a diagnostic display. DICOM specifies when, where, and how to calibrate a display. DICOM recommends regular calibration, in the center of the display with a 10% target and 20% gray surround, using a calibrated photometer.

### Dome introduced revolutionary Auto-Calibrating System

When Dome introduced the first medical imaging flat-panel displays, we knew that auto calibration was a key feature that would dramatically improve display quality and reliability. In 2001, Dome introduced the first auto-calibrating, liquid-crystal, display system.

DICOM calibration required a photometer to measure and characterize the display's behavior. This is the first and most critical step in the calibration process. To perform auto-calibration, we knew we would have to compromise when, where, or how this characterization was done. We believed that where and how must not be compromised, because that directly affected the display characterization. Instead, we compromised when.

### Most accurate characterization of the display

Dome uses true DICOM test targets and takes measurements over the full dynamic range with a high-precision, instrumentation photometer. This provides the most accurate characterization of the display possible. The characterization data is then permanently stored in the flat panel and is always available to be read back and used to perform an instant calibration at any time.

Other vendors choose to compromise where and how the display is characterized, using a tiny front sensor instead of a calibrated photometer and measuring at the very edge of the display, rather than the center. Due to bezel crimping and backlight non-uniformity, the edge of the flat panel is a poor substitute for center measurements. Using a low-precision sensor to take measurements also yields much poorer results. Not surprisingly, front sensor calibration is less accurate and more volatile, but it's hard to know this if the same front sensor is also used for QA and conformance testing as well.

### Long-term reliability

For our system to work, the display behavior must be stable over time, and it is. Over a decade of research and experience has demonstrated this. A 10-year-old Dome display is still as perfectly calibrated as it was the day it left the factory. The huge advantage of this approach is that the display will always be DICOM calibrated.



### This is calibration done right

Don't just take our word for it; we encourage you to measure for yourself. If you compare the conformance of a Dome display to any other display on the market, we are confident that you will see our superior calibration. In fact, if you do a full 256-step conformance test, you will not only see our extraordinary calibration, but you can witness the volatility of front sensor based approaches.

*Dome is a brand of NDS Surgical Imaging, global leader in medical visualization technologies. For more information, please visit [www.ndssi.com/dome](http://www.ndssi.com/dome).*

### 2. Reliable solution:

#### Image Quality one can trust

- Independently collected field data from displays ranging up to 33,000 hours of operation have shown DICOM conformance as exact as brand new displays.
- No more degradation of image quality (IQ), without any service needed. Dome offers optimum image quality over time.
- An optimal tool for reading cases is of paramount importance for the Radiologists. By using a Dome diagnostic display the Radiologist has what is needed: a monitor that can be trusted in unprecedented IQ over time. Which could potentially save patient lives.

### 3. Economical solution:

#### Total Cost of Ownership

With Dome displays hospitals don't pay twice!

At the advent of LCD panel based diagnostic monitors companies started businesses in calibration services in order to check and adjust these monitors to the ideal curve. Up until today this is the case with the majority of monitors.

Total Cost of Ownership is more and more a spear point from financial departments in healthcare systems. Effectively this means that over the typical economical lifetime expectancy of a monitor (5 – 7 years) the total costs have doubled. The hospital pays twice.

Dome displays remain in perfect DICOM calibration for life and don't need any additional field calibration, ever.

This means:

- Operational costs close to zero
- Zero maintenance (costs)
- Offering Lowest Total Cost of Ownership



DISPLAYS – MAMMO

TOTOKU · MS55i2

<b>Pixel matrix</b>	2,048 x 2,560 / 2,048 x 7,680 (with ISD)
<b>Panel size</b>	21.3"
<b>Max. luminance</b>	1,200 cd / m

**Highlights**

- LED Backlight
- 900 : 1 contrast ratio
- True 11 Bit grayscale
- ISD Support
- Front and ambient light sensor
- Remote management and calibration
- Integrated power supply
- DVI and DisplayPort interface
- Optional AR coating



TOTOKU · MS53i2

<b>Resolution</b>	2,048 x 2,560 / 2,048 x 7,680 (with ISD)
<b>Panel size</b>	21.3"
<b>Panel Technology</b>	IPS

**Highlights**

- 1,000 cd / m<sup>2</sup> brightness
- 900 : 1 contrast ratio
- True 11 Bit grayscale
- ISD Support
- Front and ambient light sensor
- Remote management and calibration
- Integrated power supply
- DVI and DisplayPort interface
- Optional AR coating

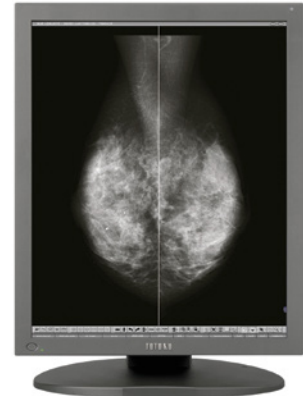

DISPLAYS – COLOR

Barco · Coronis Fusion Family

<b>Pixel matrix</b>	4 MP / 6 MP / 10 MP
<b>Panel size</b>	30"
<b>Max. luminance</b>	1,000 / 800 / 1,250 cd / m <sup>2</sup>

**Highlights**

- Wide-screen diagnostic color display systems
- Color IPS Pro LCD
- Exceptional image quality and pixel-perfect images
- Coronis feature set that provide reading productivity (19%) gains
- 30" bezel-free workspace with 33% more space
- Free MediCal QAWeb licence for automated QA & calibration
- 5-year warranty including front sensor



Barco · Nio family

<b>Pixel matrix</b>	2 MP / 3 MP / 5 MP
<b>Panel size</b>	20" / 21"
<b>Max. luminance</b>	750 / 800 / 1,100 cd / m <sup>2</sup>

**Highlights**

- Color and grayscale IPS Widescreen LCD
- Guaranteed high-bright, crisp diagnostic images
- Proven technology for long-term image confidence
- Unique auto-calibration and auto-healing features
- Built for intensive use within the reading room environment
- Free MediCal QAWeb licence for intervention-free QA & on-demand compliance checks
- 5-year warranty including front sensor



EIZO · RadiForce RS110

<b>Pixel matrix</b>	1.3 MP
<b>Panel size</b>	19"
<b>Max. luminance</b>	280 cd / m <sup>2</sup>

**Highlights**

- Diagnostic precision with DICOM part 14 factory adjustment
- Consistency with DICOM part 14 calibration
- Quick brightness stabilization for instant viewing
- Mode selection for optimum viewing
- Customer assurance with medical Standards



EIZO · RadiForce RX340

<b>Pixel matrix</b>	3 MP
<b>Panel size</b>	21.3"
<b>Max. luminance</b>	1,000 cd / m <sup>2</sup>

**Highlights**

- Consistency with DICOM part 14 calibration
- Monochrome and color images on one monitor
- Brightness uniformity for a steadier image across the screen
- Quick brightness stabilization for instant viewing
- Light sensor for measuring the ambient light conditions of the working environment
- Presence sensor for immediately activating the screen upon your return





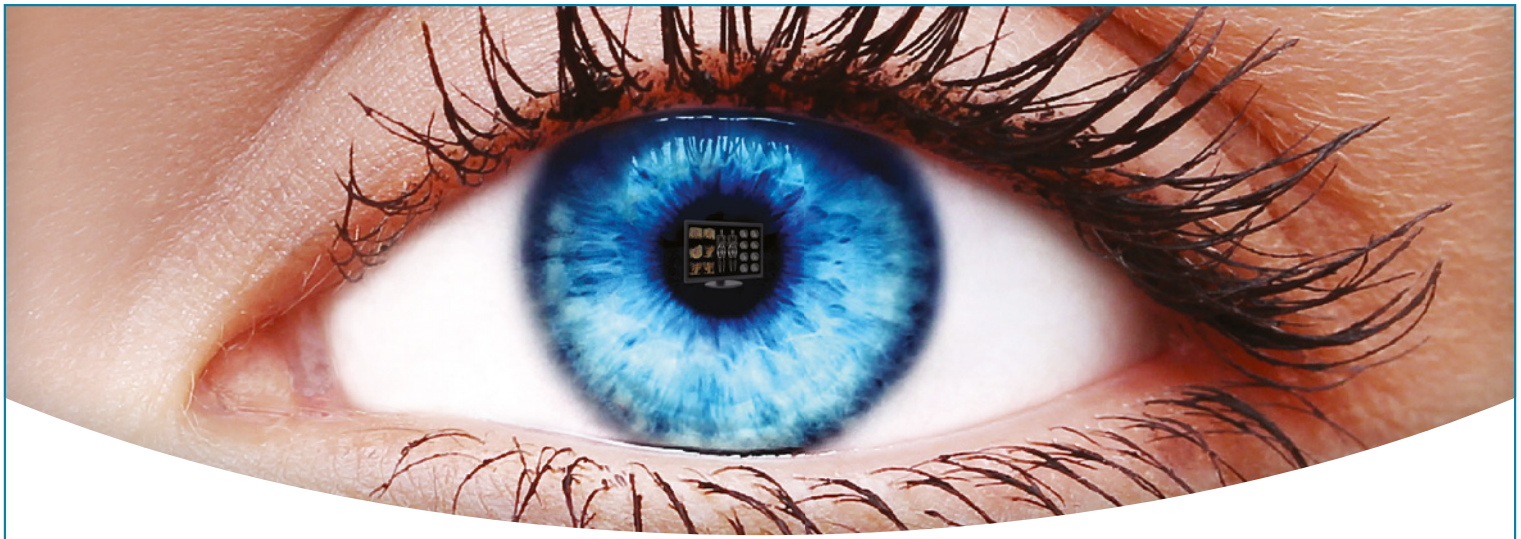

# See what you've been missing

Introducing the Dome S6c widescreen 6MP diagnostic display—a new benchmark in optical clarity. With an ultra-thin bezel, fanless cooling technology, and sleek, lightweight design, the Dome S6c brings you next generation engineering that's worth looking into.

- > Long-life LED backlight
- > 30" widescreen viewing
- > Fanless cooling
- > Factory calibrated for life
- > Ultra-slim bezel
- > Lightweight design



DISPLAYS – COLOR

EIZO · RadiForce RX240

**Pixel matrix** 2 MP  
**Panel size** 21.3"  
**Max. luminance** 760 cd/m<sup>2</sup>

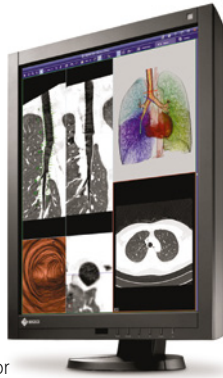

**Highlights**

- Consistency with DICOM part 14 calibration
- Monochrome and color images on one monitor
- Brightness uniformity for a steadier image across the screen
- Quick brightness stabilization for instant viewing
- Light sensor for measuring the ambient light conditions of the working environment
- Presence sensor for immediately activating the screen upon your return

EIZO · RadiForce EX270W

**Pixel matrix** 1,920 x 1,080  
**Panel size** 27"  
**Max. luminance** 600 cd/m<sup>2</sup>

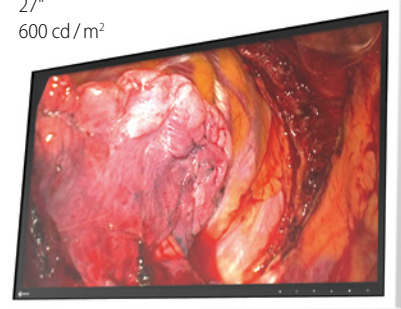

**Highlights**

- Powerful LED backlight for an optimal presentation of critical images
- Five factory calibrated look-up tables for quick and easy adaptation to diverse application and viewing environments
- Modular concept for targeted integration into current and future systems
- Sleek, encapsulated design with laminated safety glass and an unsurpassed IP rating ideally suited to the OR environment

EIZO · RadiForce RX440

**Pixel matrix** 4 MP  
**Panel size** 28.8"  
**Max. luminance** 750 cd/m<sup>2</sup>



**Highlights**

- LCD module with 4 megapixel resolution for a reliably high and constantly stable brightness
- Dual-screen display (2 x 2 MP) on one monitor
- Consistency with DICOM part 14 calibration
- Monochrome and color images on one monitor
- Brightness uniformity for a steadier image across the screen
- Light sensor for measuring the ambient light conditions of the working environment

EIZO · RadiForce RX650

**Resolution** 6 MP  
**Panel size** 30"  
**Max. luminance** 800 cd/m<sup>2</sup>



**Highlights**

- LCD module with 6 megapixel resolution and LED backlight for a reliably high and constantly stable brightness
- Dual-screen display (3 x 3 MP) on one monitor
- Consistency with DICOM part 14 calibration
- Monochrome and color images on one monitor
- Brightness uniformity for a steadier image across the screen
- Light sensor for measuring the ambient light conditions of the working environment

EIZO · RadiForce RX850

**Pixel matrix** 8 MP  
**Panel size** 31.1"  
**Max. luminance** 850 cd/m<sup>2</sup>

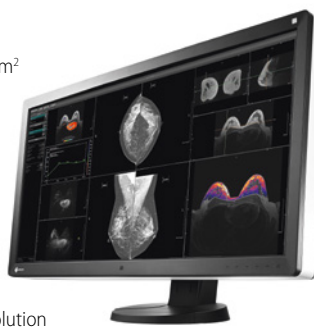

**Highlights**

- LCD module with 8 megapixel resolution and LED backlight for a reliably high and constantly stable brightness
- Dual-screen display (4 x 4 MP) on one monitor
- Consistency with DICOM part 14 calibration
- Monochrome and color images on one monitor
- Brightness uniformity for a steadier image across the screen
- Light sensor for measuring the ambient light conditions of the working environment

NDSsi · Dome S6c LED

**Pixel matrix** 6 MP Color  
**Panel size** 30"  
**Max. luminance** 800 cd/m<sup>2</sup>



**Highlights**

- Offers the latest in LCD technology to provide superb image quality and long product life.
- Lifetime DICOM calibration
- High quality, high-bright widescreen 10-bit color display
- High-speed dual link DVI
- Diamond standard for general radiology and color enhanced diagnostics
- May be used as two separate 3 MP displays with no bezel separation
- No additional field calibration is ever necessary

**NDSsi · Dome GX4MP**

**Pixel matrix** 4 MP Color  
**Panel size** 30"  
**Max. luminance** 370 cd/m<sup>2</sup>

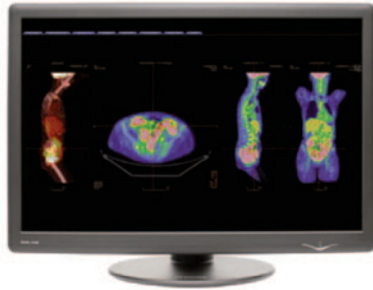

**Highlights**

Widescreen display offering multi-modality viewing in color and grayscale. Ideal for reading PET-CT, MRI, Nuclear Medicine, Ultrasound, Pathology, CR and DR.

- High-bright 4 MP 10-bit display, high-speed dual link DVI
- Fanless, lightweight, low-power
- Uncompromised image quality
- Diamond standard for general radiology and color enhanced diagnostics
- No additional field calibration is ever necessary

**NDSsi · Dome S3c**

**Pixel matrix** 3 MP  
**Panel size** 21.3"  
**Max. luminance** 800 cd/m<sup>2</sup>



**Highlights**

All-in-one diagnostic display deployable throughout the hospital enterprise.

- Diamond standard for general radiology and color enhanced diagnostics
- High-bright 10-bit diagnostic color display
- Additional RightCheck sensors for remote conformance testing
- Uncompromised image quality
- Lightweight, low-power, fanless DVI and displayport connection
- No additional field calibration is ever necessary

**NDSsi · Dome S2c LED**

**Pixel matrix** 2 MP  
**Panel size** 21.3"  
**Max. luminance** 900 cd/m<sup>2</sup>



**Highlights**

Premium 2 MP high-bright color display. Ideal for PACS imaging such as color ultrasound, 3D reconstruction, cardiology, nuclear medicine, PET-CT fusion, CT, MRI.

- High-bright 2 MP color display
- LED backlight
- Suitable for grayscale and color images
- RightCheck front sensor for remote conformance testing
- Dome displays remain in perfect DICOM Calibration for the life of the display

**NEC · Color Diagnostic Display MD322C8**

**Pixel matrix** 8 MP  
**Panel size** 32"  
**Resolution** 3,840x2,160 at 60 Hz



**Highlights**

The NEC MD322C8 flat panel display is ideal for viewing color and grayscale digital images for diagnosis by trained physicians. Imaging solutions based on standardised 8 MP image resolution support advanced medical teleconferencing. The unique built-in OPS Option Slot allows easy upgrade capability for supporting HD-SDI and 3G-SDI signal sources.

**NEC · Color Diagnostic Display MD302C6**

**Pixel matrix** 6 MP  
**Panel size** 30"  
**Resolution** 3,280x2,048 at 30 Hz; Dual 1,536x2,048 at 60 Hz; Dual 1,640x2,048 at 60 Hz



**Highlights**

The NEC MD302C6 flat panel display is ideal for viewing color and grayscale digital images for diagnosis by trained physicians. Applications include diagnostics image reporting in radiography as well as CT, MRI and other medical imaging techniques.

**NEC · Color Diagnostic Display MD302C4**

**Pixel matrix** 4 MP wide  
**Panel size** 30"  
**Resolution** 2,560x1,600



**Highlights**

The NEC MD302C4 flat panel display systems are suitable for displaying and viewing of digital images for diagnosis by trained physicians. Applications include diagnostics image reporting in radiography as well as CT, MRI and other medical imaging techniques.

- Front Sensor and LED backlight system – for long lasting stable luminance



DISPLAYS – COLOR

NEC · Color Diagnostic Display MD242C2

<b>Pixel matrix</b>	2 MP wide
<b>Panel size</b>	24"
<b>Resolution</b>	1,920x1,200



**Highlights**

The NEC MD242C2 flat panel display systems for viewing of color and grayscale digital images for diagnosis by trained physicians. Applications include diagnostics image reporting in radiography as well as CT, MRI and other medical imaging techniques.

- Front Sensor and LED backlight system – for long lasting stable luminance

NEC · Color Diagnostic Display MD211C3

<b>Pixel matrix</b>	3 MP
<b>Panel size</b>	21"
<b>Resolution</b>	1,536x2,048



**Highlights**

The NEC MD211C3 flat panel display systems for viewing of color and grayscale digital images for diagnosis by trained physicians. Applications include diagnostics image reporting in radiography as well as CT, MRI and other medical imaging techniques.

- Front Sensor and LED backlight system – for long lasting stable luminance

NEC · Color Diagnostic Display MD211C2

<b>Pixel matrix</b>	2 MP
<b>Panel size</b>	21"
<b>Resolution</b>	1,200x1,600



**Highlights**

The NEC MD211C2 flat panel display systems for viewing of color and grayscale digital images for diagnosis by trained physicians. Applications include diagnostics image reporting in radiography as well as CT, MRI and other medical imaging techniques.

- Front Sensor and LED backlight system – for long lasting stable luminance

TOTOKU · CCL650i2

<b>Panel Technology</b>	IPS
<b>Panel size</b>	30"
<b>Resolution</b>	3,280x2,048
<b>Max. luminance</b>	800 cd / m <sup>2</sup>

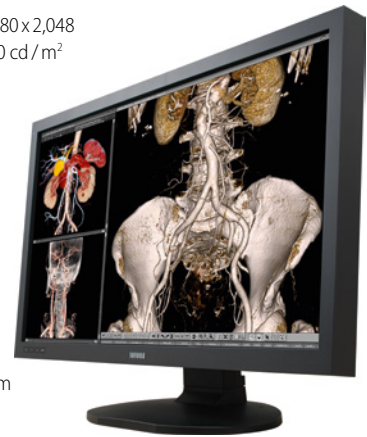

**Highlights**

- 800 cd / m<sup>2</sup> brightness
- 1,000:1 contrast ratio
- Brightness stabilization system
- Remote management
- Integrated power supply
- Dual DVI / DisplayPort Input

TOTOKU · CCL358i2

<b>Panel Technology</b>	IPS
<b>Panel size</b>	21.3"
<b>Resolution</b>	2,048x1,536
<b>Max. luminance</b>	800 cd / m <sup>2</sup>

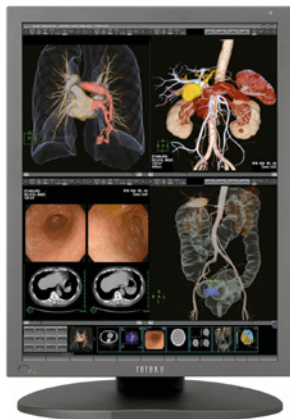

**Highlights**

- 800 cd / m<sup>2</sup> brightness
- 1400:1 contrast ratio
- Front and ambient light sensor
- Remote management and calibration
- Integrated power supply
- DVI and DisplayPort interface
- Optional AR coating

TOTOKU · CCL356i2

<b>Panel Technology</b>	IPS
<b>Panel size</b>	21.3"
<b>Resolution</b>	2,048x1,536



**Highlights**

- 800 cd / m<sup>2</sup> brightness
- 750:1 contrast ratio
- Front and ambient light sensor
- Remote management and calibration
- Integrated power supply
- DVI and DisplayPort interface
- Optional AR coating



TOTOKU · CCL258i2

<b>Panel Technology</b>	IPS
<b>Panel size</b>	21.3"
<b>Resolution</b>	1,600 x 1,200
<b>Max. luminance</b>	900



**Highlights**

- 900 cd/m<sup>2</sup> brightness
- 1400:1 contrast ratio
- Front and ambient light sensor
- Remote management and calibration
- Integrated power supply
- DVI and DisplayPort interface
- Optional AR coating

TOTOKU · CCL256i2

<b>Panel Technology</b>	IPS
<b>Panel size</b>	21.3"
<b>Resolution</b>	1,600 x 1,200



**Highlights**

- 950 cd/m<sup>2</sup> brightness
- 900:1 contrast ratio
- Front and ambient light sensor
- Remote management and calibration
- Integrated power supply
- DVI and DisplayPort interface
- Optional AR coating

TOTOKU · CCL240

<b>Panel Technology</b>	IPS
<b>Panel size</b>	24.1"
<b>Resolution</b>	1,920 x 1,200



**Highlights**

- 400 cd/m<sup>2</sup> brightness
- 1,000:1 contrast ratio
- Brightness stabilization system
- Remote management
- Integrated power supply
- Optional AR coating

TOTOKU · CCL230

<b>Panel Technology</b>	IPS
<b>Panel size</b>	19.6"
<b>Resolution</b>	1,600 x 1,200
<b>Max. luminance</b>	700 cd/m <sup>2</sup>



**Highlights**

- 700 cd/m<sup>2</sup> brightness
- 1000:1 contrast ratio
- Brightness stabilization system
- Remote management
- Integrated power supply

DISPLAYS – GRAYSCALE

Barco · Coronis Family

<b>Panel size</b>	20" / 21"
<b>Resolution</b>	3 MP / 5 MP
<b>Max. luminance</b>	1,650 / 1,000 / 1,100 cd/m <sup>2</sup>



**Highlights**

Diagnostic color display systems.  
Color and grayscale LCD and LED versions:

- Unsurpassed film-like images with ultra-high resolution
- Unrivaled brightness, contrast and viewing angle
- Complete diagnostic confidence under all lighting conditions
- Free MediCal QAWeb licence for automated QA & calibration
- 5-year warranty including front sensor

EIZO · RadiForce GX340

<b>Pixel matrix</b>	3 MP
<b>Panel size</b>	21.3"
<b>Max. luminance</b>	1,200 cd/m <sup>2</sup>



**Highlights**

- Consistency with DICOM part 14 calibration
- Easy calibration with integrated front sensor
- Quick brightness stabilization for instant viewing
- Brightness uniformity for a steadier image across the screen
- Light sensor for measuring the ambient light conditions of the working environment
- Presence sensor for immediately activating the screen upon your return

DISPLAYS – GRAYSCALE

EIZO · RadiForce GX240

**Pixel matrix** 2 MP  
**Panel size** 21.3"  
**Max. luminance** 1,200 cd/m<sup>2</sup>



**Highlights**

- Environmentally-friendly LED backlight
- Consistency with DICOM part 14 calibration
- Easy calibration with integrated front sensor
- Quick brightness stabilization for instant viewing
- Brightness uniformity for a steadier image across the screen
- Light sensor for measuring the ambient light conditions of the working environment

NDSsi · Dome S3 LED

**Pixel matrix** 3 MP  
**Panel size** 21.3"  
**Max. luminance** 1,700 cd/m<sup>2</sup>



**Highlights**

- Premium 3 MP Diagnostic display with Dome RightCheck front sensor technology.
- Diamond standard for high-end radiology, ideal for X-ray chest, CT and MRI
  - RightLight-guaranteed lifetime DICOM calibration
  - Uncompromised image quality
  - Fanless, lightweight, low-power
- High-bright 10-bit grayscale display
  - True 10-bit high-resolution grayscale glass
  - No additional field calibration is ever necessary

NDSsi · Dome E2 / E3

**Pixel matrix** 2 MP / 3 MP  
**Panel size** 21.3" / 20.8"  
**Max. luminance** 1,000 cd/m<sup>2</sup>



**Highlights**

**E2:** Image quality that can be affordably deployed throughout the enterprise. Pristine grayscale imaging in a compact display.

- E3:** High luminance and contrast and pristine image quality.
- Diamond standard for high-end radiology
  - Guaranteed lifetime DICOM calibration

- Fanless, flexible, lightweight, low-power
- High-bright 10-bit grayscale display
- No additional field calibration is ever necessary

NEC · Grayscale Diagnostic Display MD211G3

**Pixel matrix** 3 MP  
**Panel size** 21"  
**Resolution** 2,048 x 1,536



**Highlights**

- The NEC MD211G3 is designed for viewing of grayscale digital images for diagnosis by trained physicians. Application include diagnostic image reporting in radiography.
- Unique re-calibratable Front Sensor System for latest QA conformance capability
  - GammaCompMD QA Client Software compatible

TOTOKU · MS33i2

**Panel Technology** IPS  
**Panel size** 20.8"  
**Resolution** 1,536 x 2,048 / 1,536 x 6,144 (with ISD)

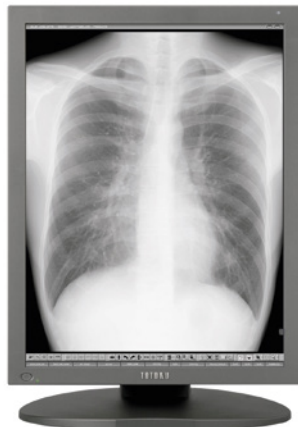

**Highlights**

- 1,800 cd/m<sup>2</sup> brightness
- 700:1 contrast ratio
- True 11 Bit grayscale
- ISD Support
- Front and ambient light sensor
- Remote management and calibration
- Integrated power supply
- DVI and DisplayPort interface
- Optional AR coating

TOTOKU · MS23i2

**Panel Technology** IPS  
**Panel size** 21.3"  
**Resolution** 1,600 x 1,200 / 4,800 x 1,200 (ISD)



**Highlights**

- 1,800 cd/m<sup>2</sup> brightness
- 700:1 contrast ratio
- True 11 Bit grayscale
- ISD Support
- Front and ambient light sensor
- Remote management and calibration
- Integrated power supply
- DVI and DisplayPort interface
- Optional AR coating



## Medical treatment perfect in focus

### Diagnostic – Review – Conference and Education – Administration

Your patients trust your diagnosis. Just as important is the trust you place in the manufacturer of display solutions for all your medical application fields. Your partner with many years of experience in this field, with an outstanding service and support concept for highly sensitive and complex applications in hospitals and medical clinics.

Trust in NEC Display Solutions, the leading manufacturer of display products and solutions. Rely on certified Medical Displays for film-less diagnosis and review, DICOM calibrated monitors for PACS applications, LCD screens from 19 to 80 inch and a wide selection of projectors. Benefit from tailor-made visual solutions and the technical expertise of NEC Display Solutions. And you can focus completely on your patients.

For more information visit



[www.medical.nec-display-solutions.com](http://www.medical.nec-display-solutions.com)





DISPLAYS – GRAYSCALE

TOTOKU · ME193

<b>Panel Technology</b>	IPS
<b>Resolution</b>	1,280 x 1,024
<b>Panel size</b>	19.1"



**Highlights**

- 1,500 cd/m<sup>2</sup> brightness
- 1,000:1 contrast ratio
- Brightness stabilization
- DVI and Video input to connect modality systems

DISPLAYS – CLINICAL REVIEW

Barco · Eonis Family

<b>Resolution</b>	2 MP (1,920 x 1,080)
<b>Panel size</b>	22" / 24"



**Highlights**

- Protective toughened, scratch proof glass cover
- 100% cleanable (70% alcohol) design supports hospital infection control initiatives
- IEC 60601-1 for use within 1m of patients
- Desk or cart-mounted for ultimate flexibility
- QA management and asset management
- 3-year warranty incl. front sensor

EIZO · RadiForce MX191

<b>Pixel matrix</b>	1.3 MP
<b>Panel size</b>	19"
<b>Max. luminance</b>	300 cd/m <sup>2</sup>



**Highlights**

- DICOM part 14 compliant plus simplified calibration
- Brightness stabilization
- Mode selection for optimum viewing
- Customer assurance with medical standards

EIZO · RadiForce MX242W

<b>Pixel matrix</b>	2.3 MP
<b>Panel size</b>	24.1"
<b>Max. luminance</b>	350 cd/m <sup>2</sup>



**Highlights**

- View more with widescreen and wide viewing angles
- DICOM part 14 compliant, simplified calibration
- Brightness stabilization
- Brightness uniformity for a steadier image across the screen
- Customer assurance with medical standards

EIZO · RadiForce MX215

<b>Pixel matrix</b>	2 MP
<b>Panel size</b>	21"
<b>Max. luminance</b>	420 cd/m <sup>2</sup>

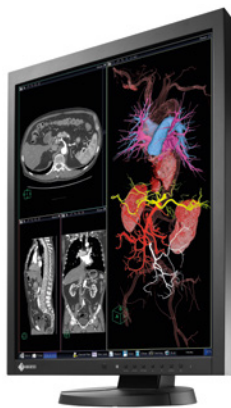

**Highlights**

- DICOM part 14 compliant plus simplified calibration
- Brightness stabilization
- Selection for optimum viewing
- Customer assurance with medical standards

EIZO · RadiForce MX270W

<b>Pixel matrix</b>	3.7 MP
<b>Panel size</b>	27"
<b>Max. luminance</b>	300 cd/m <sup>2</sup>



**Highlights**

- Environmentally-friendly LED backlight
- View more with widescreen and wide viewing angles
- DICOM part 14 compliant, simplified calibration
- Brightness stabilization
- Brightness uniformity for a steadier image across the screen



**NDSsi · Dome GX2MP Plus**

<b>Pixel matrix</b>	2 MP Color
<b>Panel size</b>	20.1"
<b>Max. luminance</b>	250 cd / m <sup>2</sup>



**Highlights**

High-quality color display ideal as a companion monitor for the Dome EX and S series of displays. Suitable for primary diagnostics on CT, MRI and PET and for review on general X-ray.

- High Quality 2 MP color display
- High-speed DVI
- Also suitable for RIS

- DICOM calibrated "out of the box"
- Stabilized backlight
- Fanless, lightweight, low-power
- No additional field calibration is ever necessary

**NEC · Operating Room Display MD462OR**

<b>Panel Technology</b>	S-PVA
<b>Resolution</b>	1,920 x 1,080
<b>Panel size</b>	46"

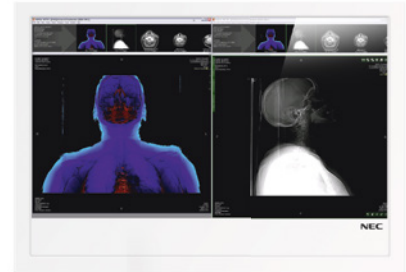

**Highlights**

The NEC MD462OR flat panel display system is ideal for viewing of color and grayscale medical images in operations rooms by trained physicians. Using the latest technologies in Full HD LCD panels and connectors/video signals management, and the highest standards for reliability and image quality, this product is the reference in the medical market.

**NEC · Clinical Review Display MDview272**

<b>Panel Technology</b>	AH-IPS
<b>Resolution</b>	2,560 x 1,440
<b>Panel size</b>	27"



**Highlights**

The professional 27 inch DICOM calibratable display for medical image viewing and PACS referral fulfils dedicated quality requirements for reproduction of images from Computed Tomography, Magnetic Resonance Imaging, Nuclear Medicine / PET and Cardiology as well as PACS referral.

**NEC · Clinical Review Display MDview243**

<b>Panel Technology</b>	IPS
<b>Resolution</b>	1,920 x 1,200
<b>Panel size</b>	24"



**Highlights**

The NEC MDview243 color flat panel display fulfils dedicated quality requirements for reproduction of images from Computed Tomography, Magnetic Resonance Imaging, Nuclear Medicine / PET and Cardiology as well as PACS referral.

**NEC · Clinical Review Display MDview232**

<b>Panel Technology</b>	IPS
<b>Resolution</b>	1,920 x 1,080
<b>Panel size</b>	23"



**Highlights**

The NEC MDview232 color flat panel display fulfils dedicated quality requirements for reproduction of images from Computed Tomography, Magnetic Resonance Imaging, Nuclear Medicine / PET and Cardiology as well as PACS referral.

**DISPLAYS – LARGE FORMAT**

**EIZO · RadiForce LS580W**

<b>Pixel matrix</b>	8 MP
<b>Panel size</b>	57.5"
<b>Max. luminance</b>	700 cd / m

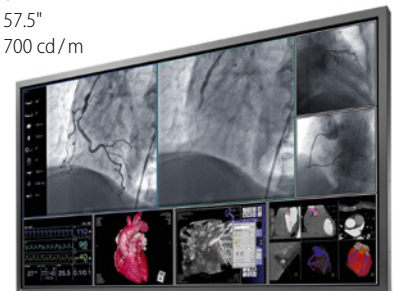

**Highlights**

- 58-inch LCD module with 8 megapixel (4k ultra HD) resolution
- Redundant components architecture for a high degree of operational reliability
- Grayscale tones adjusted to DICOM Part 14 standard for optimum viewing of medical DICOM images
- Five user-selectable 11-bit look-up tables enable accurate viewing of any type of medical image Homogeneous brightness uniformity across the entire screen

## DISPLAYS – LARGE FORMAT

### EIZO · RadiForce LX470W

<b>Pixel matrix</b>	2.1 MP
<b>Panel size</b>	47"
<b>Max. luminance</b>	700 cd/m <sup>2</sup>

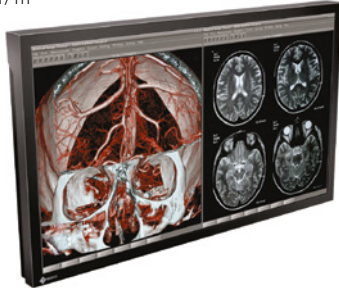

#### Highlights

- Wide viewing angles for multiple people use
- Diagnostic precision with factory adjustment
- Consistency with DICOM part 14 calibration
- Quick brightness stabilization for instant viewing
- Wide range of input and output support

### EIZO · RadiForce LX300W

<b>Pixel matrix</b>	4 MP
<b>Panel size</b>	29.8"
<b>Max. luminance</b>	750 cd/m <sup>2</sup>



#### Highlights

- Multi monitor scenarios in a single glance
- Environmentally-friendly LED backlight
- Diagnostic precision with factory adjustment
- Quick brightness stabilization for instant viewing
- Customer assurance with medical standards

### EIZO · RadiForce LX600W

<b>Pixel matrix</b>	8 MP
<b>Panel size</b>	60"
<b>Max. luminance</b>	520 cd/m <sup>2</sup>

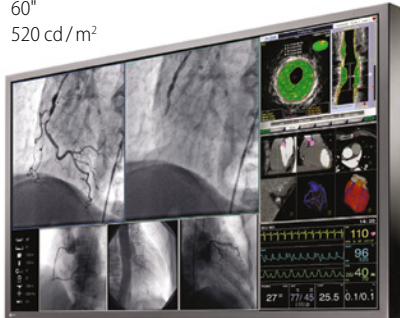

#### Highlights

- Multi monitor scenarios in a single glance
- Environmentally-friendly LED backlight
- Diagnostic precision with factory adjustment
- Quick brightness stabilization for instant viewing
- Wide range of input and output support

### Sectra · Sectra Table for medical education



#### Highlights

- A 46-inch medical multi-touch display enabling multiple users to interact collaboratively and simultaneously with the real-size 3D images generated by CT and MRI scanners to gain deeper understanding and insight into the functions and processes inside the body. The user can, for example, visualize different kinds of tissues and cut through sections with a virtual knife. The table makes a significant contribution to medical education. The table is powered by a tailored Sectra PACS workstation. Sectra's patented visualization techniques even allow immediate display of datasets of extreme size, such as high-resolution, full-body scans.

## PRINTERS

### Agfa · DRYSTAR 5503

<b>Technology</b>	Direct digital imaging
<b>Capacity</b>	100 films/h (14 x 17)
<b>Resolution</b>	508 dpi / 50 µm pixelsize



#### Highlights

- Multi-modality, high throughput imager with film sorter
- Ideal for centralized workflow, can easily be connected to the network
- Integrated A#Sharp technology for optimized image quality
- 3 multi-format trays, each supporting different film sizes and types
- Suitable for CT, MRI, DSA, digital R/F, CR, DR and optional mammography applications

### Agfa · DRYSTAR AXYS

<b>Technology</b>	Direct digital imaging
<b>Capacity</b>	75 films/h (14 x 17)
<b>Resolution</b>	508 dpi / 50 µm pixelsize



#### Highlights

- Flexible, tabletop imager delivering mammography-quality images
- Multi-application hardcopy solution, including digital mammography
- Integrated A#Sharp technology for optimized image quality
- 2 multi-format trays, each supporting different film sizes and types
- Very short access time for extremely fast delivery of first four prints

**Agfa · DRYSTAR 5302**

**Technology** Direct digital imaging  
**Capacity** 75 films/h (14 x 17)  
**Resolution** 320 dpi



**Highlights**

- Suitable for all applications and ideal for CR/DR
- A#Sharp technology for optimized image quality
- Convenient imaging with two media sizes on-line (multi-format)
- Very short access time ensures fast printing of small print jobs

**Agfa · DRYSTAR 5300**

**Technology** Direct digital imaging  
**Capacity** 70 films/h (14 x 17)  
**Resolution** 320 dpi



**Highlights**

- Tabletop, next-to-application Direct Digital Imager
- Suitable for all applications and ideal for CT/MR
- Reliable, low maintenance printer
- A#Sharp image enhancement for excellent quality
- Very short access time ensures fast printing of small print jobs

**FUJIFILM · DryPix Lite**

**Technology** Thermal head transfers heat while in contact with thermal film  
**Capacity** Approx. 90 sheets/hour  
**Resolution** 84.7 µm (300 dpi), 12 bits gradation



**Highlights**

- A new concept tabletop Dry Imager
- Supports multiple film size
- Daylight film loading
- Up to 2 magazines
- Outstanding performance, remarkable efficiency and superb quality satisfy your medical needs

**FUJIFILM · DryPix Plus**

**Technology** Laser exposure thermal development system  
**Capacity** Up to 160 films/h (35 x 43 cm) and 230 films/h (20 x 25 cm); 60 s first print  
**Resolution** 100/50 micron is selectable for all sizes, 14 bits



**Highlights**

- 3 daylight film loading trays
- 4 available film formats from 20x25 cm up to 35x43 cm
- Up to 4 bin film sorter
- High resolution and density for mammography (Dmax = 4.0)
- Quick cold start time
- DICOM compatible
- Automatic density correction

**FUJIFILM · DryPix Smart**

**Technology** Laser exposure thermal development system  
**Capacity** up to 80 films/h  
**Resolution** 50 micron, 14 bits gradation



**Highlights**

- Tabletop laser printer
- 2 Trays for multiple film sizes
- 0.38 m<sup>2</sup> footprint
- Support for 5 different film formats
- Fully DICOM compatible
- Automatic density adjustment

**medigation · DICOM PaperPrint**

**Format** DIN A3, 11 x 17 inch  
**Capacity** Up to 120 paper prints/h  
**Resolution** 1,200 x 2,400 dpi (print), 600 x 600 dpi (copy)



**Highlights**

- Supports all DICOM 3.0 modalities (e.g. CT, MRT, CR, DR, US, NUK, etc)
- Supports one or more PostScript printers within the network
- General licence package (no restrictions on how many DICOM modalities are connected)
- Image header and footer customizable incl. physician logo
- Separate LUT (Look Up Table) for each printing system
- GSDF calibration according IHE



# DISPLAYS/PRINTERS

## CD- /DVD ROBOT

### CHILI · Burn Gateway



#### Highlights

- Receives data by DICOM C-Store
- Burns data on one or more CD/DVDs
- Optional reports
- Individual label printing
- Client enabled (different logos)
- CHILI viewer in report quality
- Alternative presentation as HTML/jpeg

- Certified by OFFIS and DRG
- Works with any PACS
- External output tray!

### CHILI · Import Robot



#### Highlights

- Automatic import robot
- Import of patient CD/DVD
- 2, 5 or 10 drives
- 2 import trays (regular/express)
- 2 output trays (ok, failed)
- Optional virus scan

- Correction of foreign data
- Automatic DICOM transfer
- Works with any PACS

## medigration · CD-Imager

- Format** CD-R, DVD-R, DVD+R, DVD-R DL, DVD+R DL  
**Capacity** 30 CDs/h or 15 DVDs/h (burn and print)  
**Magazine size** 2 x 50 pcs



- Fully automatic compact system for creating DICOM patient CDs or DVDs
- Highly compatible with all digital DICOM modalities (multimodality)
- Individual labeling (practice / clinic logo)
- Easy integration of DICOM patient data
- Extremely cost effective due to quick printing times and low link consumption

## ACCESSORIES / COMPLEMENTARY SYSTEMS

### NDSsi · DomeAccess



#### Highlights

Is deployed throughout the hospital and used to easily manage the Dome family of medical display workstations.

**ACCESS:** Intuitive web user interface & convenient accessibility provides a secure solution.

**BACKUP:** Using the backup service option Dashboard server data can be backed up to the cloud.

**CONFIDENCE:** Hosted and maintained in the cloud and monitored by Dome.

## NDSsi · Video Informatics Platform Solutions



#### Highlights

Informatics platforms for real-time image management, distribution, control from multiple sources and incorporation of Internet connectivity for streaming video and image routing throughout the hospital and beyond. Full Duplex Audio is included in streaming.

ConductOR – Video Informatics  
 ScaleOR – Video Scaling  
 ExpandOR – HD Video Streaming  
 ZeroWire – Medical-grade wireless video solution

## NDSsi · Radiance Series

- Panel size** 19" / 24" / 26" / 32" / 42" / 55"  
**Technology** NDSsi's proprietary Color Correction Technology (CCT)  
**Max. luminance** Features a "DICOM" gamma correction setting for viewing PACS images, providing luminance response characteristics similar to that of a DICOM-compliant display

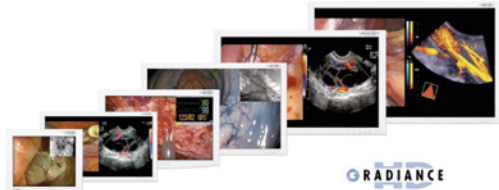

#### Highlights

For minimally invasive surgery and interventional procedures.

- Features "DICOM" gamma correction settings for viewing PACS images
- Allows any two input sources to be viewed simultaneously on the same display
- LED Backlight
- Fully Compliant with OR Video Control Applications
- Proven compatibility with endoscopic cameras, fluoroscopes, ultrasound machines and other medical imaging systems





# QBit

Smart Ultrasound



Scan QR code

**CHISON**  
Value Beyond Imaging

# Ultrasound



See the future

# SIUI

## Apogee 5500



ECR: **Extension Expo A,  
No.10**



SIUI



SIUI

Mail: [siui@siui.com](mailto:siui@siui.com)  
Website: [www.siui.com](http://www.siui.com)

**Chison · i9**

**Mode** B, 2B, 4B, B/M, 2D Steer BC, CFM PW, HPRF, CW PD, Directional PD Instant Triplex, Duplex, Quadplex Trapezoidal Curved Panoramic Imaging(option) 4D (option) Chroma B/M/PW/CW ECG (option) Free Steering M (option) Color M (option)

**Transducer inputs** 4

**Highlights**

- 19" high definition LED monitor with 270° rotation angle
- 10.4" touch screen for more user friendly workflow
- Integrated gel warmer
- 2.5 MHz – 18 MHz operating frequency range
- THI, SRA, Fusion harmonic
- Universal Compound Imaging
- i-Image / 2D Steer / Curved Panoramic Imaging
- IMT / Elastography / Super needle
- Advanced 4D technologies: 4D probe and display package, Virtual HD, Depth view
- Professional Cardiac packages



**Chison · i8**

**Scan format** Convex,Linear,Transvaginal,Phased array,4D Volume,Micro-Convex,Pediatric

**Mode** B, 2B, 4B, B/M, 2D Steer BC, CFM PW, HPRF, CW PD, Directional PD Instant Triplex, Duplex, Quadplex Trapezoidal Curved Panoramic Imaging(option) 4D (option) Chroma B/M/PW/CW ECG (option) Free Steering M (option) Color M (option)

**Transducer inputs** 4

**Weight** 130 kg

**Highlights**

- 19" high definition LCD Monitor, 4 probe connectors
- Advanced 4D technologies: 4D probe and display package, Virtual HD, Depth View
- Advanced Imaging Technologies: THI, SRA, Compounding, i-Image, Quadplex
- Elastography, Super Needle, 2D Steer
- Shared Service: Cardiac, Vascular, AB, OB / GYN, MSK, Small Parts, Urology and Pediatric
- Professional Cardiac package



**Chison · i3**

**Mode** B, 2B, 4B, B/M, M CFM PW Mode Power Doppler / Directional PD Trapezoidal Real-time 4D (Option) Chroma B / PW

**Scan format** Convex probe Linear probe Linear probe (60mm) Transvaginal probe Micro-Convex probe 4D Volume probe Wideband, Multi-frequency

**Transducer inputs** 4

**Weight** 130 kg

**Highlights**

- 19" LCD, 4 probe connectors
- Advanced 4D technology
- Superb image: Compound imaging, SRA, i-Image
- Comprehensive OB & GYN package
- Streamlined workflow
- EasyView archive system
- DICOM 3.0, PC & Video printer
- Great value for OB & GYN, General imaging



**Chison · SonoTouch 30**

**Mode** B, CFM, PW, M, 2B, 4B

**Transducer inputs** 1 for main unit, 3 with cart (option)

**Weight** 7 kg

**Highlights**

- Touch screen, icon-driven, easy to use
- Quick boot within 30 seconds
- Long battery life up to 2.5 hours
- Compact, durable, water proof (from panel)
- High resolution LED screen
- Portable stand with adjustable viewing angles
- Versatile imaging functions and report management software

- USB and DICOM 3.0
- Super Needle
- B, CFM, PW, M, 2B, 4B



**Chison · Q9**

**Scan format** Convex, Linear, Phased array, Volume, Micro convex

**Mode** B, 2B, 4B, B/M, 2D Steer BC, CFM PW, HPRF, CW PD, Directional PD Instant Triplex, Duplex, Quadplex Trapezoidal Curved Panoramic Imaging(option) 4D (option) Chroma B/M/PW/CW ECG (option) Free Steering M (option) Color M (option) TDI (option)

**Transducer inputs** 2

**Weight** 20 kg

**Highlights**

- 15" high definition LCD Monitor
- Dual probe connectors
- Advanced 4D technologies: 4D probe and display package, Virtual HD, Depth View
- Advanced Imaging Technologies: THI, SRA, Compounding, i-Image, Quadplex
- Elastography, Super Needle
- Shared Service : Cardiac, Vascular, ABD, OB / GYN, MSK, Small Parts, Breast, Urology and Pediatric



**Chison · Q5**

**Scan format** Convex, Linear, Transvaginal, Transvaginal, Volume, Micro-Convex, Pediatric

**Mode** B, 2B, 4B, B/M, M CFM PW Mode Power Doppler / Directional PD Trapezoidal Real-time 4D (Option) Chroma B / PW

**Transducer inputs** 2

**Highlights**

- 15" LCD monitor
- Advanced 4D technology: 4T (Fast, Light, Quiet, Smart)
- Professional OB report package
- B, CFM, PW, Power Doppler and Directional Power Doppler
- Trapezoidal Mode
- Streamlined workflow
- Dual probe connectors

- Advanced technologies: SRA, Compound Imaging, THI, i-Image





**Chison · ECO5**

<b>Mode</b>	B, C, M, PW
<b>Scan format</b>	B, B/B, 4B, M, B/M, CFM, PW, Trapezoidal
<b>Transducer inputs</b>	2
<b>Weight</b>	6.5 kg (with built-in battery)



**Highlights**

- Ultra-portable color ultrasound system
- PW Doppler with auto-trace
- Additional phased array probe
- Wide viewing angle (0 – 180°), from left to right
- Built-in battery (2.5 hours)
- 12 inch rotatable LED monitor (0 – 30°)
- One key to full screen
- 8G memory card

**Chison · ECO1**

<b>Mode</b>	B, B/B, 4B, M, B/M
<b>Scan format</b>	Convex, Linear, Micro-Convex, Transvaginal
<b>Transducer inputs</b>	2
<b>Weight</b>	6.5 kg (with built-in battery)



**Highlights**

- Advanced image technologies: THI, SRA, i-Image, Compound imaging
- 8G memory card
- Dual probe connectors
- Trapezoidal
- High resolution LED monitor 30° rotatable
- One key to full screen
- Anti-water keyboard cover
- Chroma
- Better solution for accessories: Carry case & CartTR9000

**Esaote · MyLabTwice**

<b>Mode</b>	2D, 3D, 4D, M, CMM, CFM-PWD, XFlow, PW, CW, CnTI and others
<b>Scan format</b>	Convex, Linear, Phased Array, Extended, 3D Panoramic and Volumetric
<b>Transducer inputs</b>	4 & 1 probe connectors



**Highlights**

- Premium system with Point-of-Care portable ultrasound unit optionally integrated
- Outstanding Ergonomics with intuitive Touch Screen panel, user friendly workflow
- Superb Imaging, Colour and Spectral Doppler with Advanced Technologies (Elaxto, Low MI CEUS, Fusion Imaging, 3D & 4D, QIMT, QAS, etc...) applicable to different types of transducer and to extensive range of clinical applications

**Esaote · MyLabClassC**

<b>Mode</b>	2D, 3D, 4D, M, CMM, CFM, PW, CW, PWR, XFlow CnTI and others
<b>Scan format</b>	Convex, Linear, Phased Array, Extended, 3D Panoramic and Volumetric
<b>Transducer inputs</b>	4 & 1 probe connectors



**Highlights**

- High-end System, perfect choice for high performance combined with excellent ergonomics (including Touch Screen) and user friendly workflow.
- Superb Imaging, Colour and Spectral Doppler with Advanced Technologies (Elaxto, Low MI CEUS, Fusion Imaging, 3D & 4D, QIMT, QAS, etc ...)
- Multidisciplinary Digital Platform for General Imaging, Women's Health, Cardiovascular and other clinical applications

**Esaote · MyLabSeven**

<b>Mode</b>	2D, 3D, 4D, M, CMM, CFM, PW, CW, PWR, XFlow and others
<b>Scan format</b>	Convex, Linear, Phased Array, Extended, Panoramic and Volumetric
<b>Transducer inputs</b>	4 probe connectors



**Highlights**

- Focused on the real diagnostic value, this innovative system delivers high-class imaging performance and compact size in Cardiac, Vascular, Womens' Healthcare and General Imaging applications
- The intelligent software and touch-screen allow unique features
- This system provides easy access, personalized settings, standardized protocols
- Adv. features available, i. e.: Elaxto, CEUS and Strain4D

**Esaote · MyLabSix**

<b>Mode</b>	2D, 3D, 4D, M, CMM, CFM, PW, CW, PWR and others
<b>Scan format</b>	Convex, Linear, Phased Array, Extended, Panoramic and Volumetric
<b>Transducer inputs</b>	3 Probe connectors



**Highlights**

- MyLabSix is the Premium Choice for an affordable Share Service Ultrasound
- The system is design to maximise user comfort and diagnostic confidence
- Includes 19" Wide screen monitor, Touch Screen and easy workflow
- With its extended transducer range, the system is perfect for many clinical applications from application specific to fully share services
- Ultra-low power consumption, Green Product

**Esaote · MyLabAlpha**

<b>Mode</b>	2D, 3D, 4D, M, CMM, CFM, PW, CW, PWR, XFlow and others
<b>Scan format</b>	Convex, Linear, Phased Array, Extended, Panoramic and Volumetric
<b>Transducer inputs</b>	2 on board, 2 with roll stand

**Highlights**

- MyLabAlpha is a premium portable system, designed to deliver top performance for both imaging and ergonomics in small size and weight
- This ultrasound system is for all clinical applications due to the customized settings and multiple functions that can be organized according to the preferences of every clinical practice
- Advanced technologies available such as Elaxto, CEUS, XStrain4D



**Esaote · MyLabGamma**

<b>Mode</b>	2D, 3D, 4D, M, CMM, CFM, PW, CW, PWR and others
<b>Scan format</b>	Convex, Linear, Phased Array, Extended, Panoramic and Volumetric
<b>Transducer inputs</b>	2 on board, 2 with roll stand

**Highlights**

- MyLab Gamma sets ultrasound free bringing superb quality imaging and fast, accurate diagnosis to the Point-of-Care in any situation – wherever and whenever
- Incorporating high resolution imaging, advanced technologies, and supporting a range of probes. It is an optimal solution for Cardiovascular, General Imaging and a range of other applications
- Ultra-low power consumption, Green Product



**Esaote · MyLabOne**

<b>Mode</b>	2D, M, CFM, PWD, PW and others
<b>Scan format</b>	Convex, Linear, Phased Array and Extended
<b>Transducer inputs</b>	1 on board, 3 on roll stand

**Highlights**

- Dedicated solution for Point Of Care
- Intuitive user interface, fully based on touch screen technology
- Wireless connectivity
- Fast workflow / Easy to clean / On-board library
- Remote controls integrated on the transducers
- NNE technology for enhancement of needle visibility
- XHF technology, up to 22 MHz
- QIMT and QAS, for accurate and easy assessment of IMT and arterial stiffness, based on RF technology



**Buy & sell used equipment on**

**DOTmed®**

[www.dotmed.com](http://www.dotmed.com)

**Over 400,000 listings**

**Over 20,000 daily visitors**

**GE Healthcare · LOGIQ E9**

<b>Modus</b>	B-mode, M-mode, CFM-mode, Doppler, CEUS-mode, elastography-mode, realtime 4D, volume navigation
<b>Scan format</b>	Linear, convex, microconvex, sector phased array, trapezoid
<b>Transducer inputs</b>	4

**Highlights**

- Extraordinary images: agile ultrasound beamformers with acoustic models, Matrix Array transducer technology, single crystal, CrossXBeam, SRI
- Expert tools: contrast imaging with new hires and amplitude modulation settings, elastography and PDI with quantification, realtime 4D in CEUS mode, volume navigation with fusion, GPS and needle tracking
- Easy workflow: scan assistant, raw data imaging, Q&R with multimodality imaging navigation



**GE Healthcare · LOGIQ S8**

<b>Modus</b>	B-mode, M-mode, CFM-mode, Doppler, B-flow mode, CEUS-mode, elastography-mode
<b>Scan format</b>	Linear, convex, microconvex, sector phased array, trapezoid
<b>Transducer inputs</b>	4 active ports + 1 parking slot

**Highlights**

- Superb imaging: S-Agile ultrasound beamformers, matrix array transducer technology, single crystal, contrast imaging with amplitude modulation settings, elastography with quantification, B-flow imaging
- Simplified workflow: slim and light console, fully flexible configuration
- Scalable to your needs: wide applications coverage to maximize scan productivity.
- Scan assistant, raw data imaging



**GE Healthcare · Voluson E8**

<b>Modus</b>	B-mode, M-mode, CFM-mode, Doppler, HD-flow, realtime 4D
<b>Scan format</b>	Linear, convex, microconvex, sector phased array
<b>Transducer inputs</b>	3



**Highlights**

- Realtime 4D up to 40 volumes / s
- Automatic volumetric analysis
- STIC (Realtime 4D view of the fetal heart)
- CRI (Compound Resolution Imaging)
- HD-Flow (high sensitive power Doppler)

**GE Healthcare · LOGIQ P6 Premium**

<b>Modus</b>	B-mode, M-mode, CFM-mode, Doppler, B-flow color, coded contrast harmonic, stressecho, anatomical M-mode, elastography-mode
<b>Scan format</b>	Linear, convex, microconvex, sector phased array, trapezoid
<b>Transducer inputs</b>	3



**Highlights**

- Compact shared service system B-flow color (digitally subtraction technique)
- CrossXBeam realtime compound and speckle reduction imaging
- LOGIQView (panoramic imaging)
- Auto optimize (For B-mode, color, Doppler)
- Digitally archive with RawData support
- Matrix array transducer support
- Elastography

**GE Healthcare · LOGIQ A5 / P5 Premium**

<b>Modus</b>	Modular configurable from b/w system up to color triplex system (B-mode, M-mode, CFM-mode, Doppler, B-flow, cardiology)
<b>Scan format</b>	Linear, convex, microconvex, sector phased array, trapezoid
<b>Transducer inputs</b>	3



**Highlights**

- Compact lightweight and modern design with 15" LCD monitor
- CrossBeam and speckle reduction imaging
- LOGIQView (panoramic imaging)
- Auto optimize (for B-mode, color, Doppler)
- Digitally archive with RawData support
- Elastography (LOGIQ P5 Premium)

**GE Healthcare · Venue 40**

<b>Modus</b>	B-mode, color flow imaging, power Doppler
<b>Scan format</b>	Linear, convex, sector phased array
<b>Transducer inputs</b>	1



**Highlights**

- No buttons – no knobs – no keyboard -easy to use at the point of care
- Concurrent acquisition technology provides fast, high-resolution imaging to easily visualize anatomy and needle placement
- Depth-synchronized optimization with adjustable gain
- CrossXBeam and Speckle Reduction Imaging (SRI)
- Single-surface screen – no seams, no monitor frame

**GE Healthcare · LOGIQ e**

<b>Modus</b>	B-mode, M-mode, CFM-mode, Doppler
<b>Scan format</b>	Linear, convex, microconvex, sector phased array, trapezoid
<b>Transducer inputs</b>	1



**Highlights**

- Portable premium system with shared service capabilities
- Hockey stick probe for interventional
- Needle recognition feature for a better needle imaging
- CrossXBeam, B-steer and SRI imaging
- LOGIQ view (panoramic imaging)
- High frequency imaging up to 18 MHz for vascular and musculoskeletal exams
- Musculoskeletal suite with 2D PDI quantification and patient follow up settings

**GE Healthcare · Vscan**

<b>Modus</b>	Black and white mode for displaying anatomy in real-time, Color-coded overlay for real-time blood flow imaging
<b>Scan format</b>	Field-of-View for black and white imaging: up to 75 degrees with maximum depth of 25 cm, the color flow sector represents blood flow within an angle of 30 degrees
<b>Weight</b>	390 g (unit and probe)



**Highlights**

- The size of a smart phone: Vscan ultrasound is helping redefine the speed and depth of patient care
- Patient imaging – immediately and non-invasively – during the physical exam
- Visually validate what you feel and hear
- Small and lightweight, Vscan slips easily into a lab coat pocket
- The ample battery capacity provides over one hour of scanning on a single charge

## Hitachi Aloka · HI VISION Ascendus

<b>Mode</b>	B & M-mode; omnidirectional M-mode; PW and CW Doppler; Dual Gate Doppler; color and power Doppler; FineFlow-mode; triplex; TDI; real-time tissue elastography; contrast harmonic imaging; freehand 3D; 4D; Real-time Virtual Sonography; Real-time Bi-plane
<b>Scan format</b>	Sector, linear and convex array, 360° electronic radial scanning, trapezoid, B-steer, dual imaging, WideView panoramic, HI-Definition Zoom, pan Zoom; Picture in Picture
<b>Transducer inputs</b>	4 active ports

### Highlights

- Award-winning, unique ergonomic design with increased system flexibility
- Graphical user interface with smart tab menus, image thumbnails and touchscreen panel for image optimization
- Optional expert modalities: real-time elastography, contrast harmonic imaging, multi-modality fusion imaging
- Supports leading edge technologies such as 4D-elastography and real-time automatic ejection fraction



## Hitachi Aloka · ProSound F75

<b>Mode</b>	B & M-mode; free angle M-mode; PW and CW Doppler; color and power Doppler; eFlow-Flow Emphasis; triplex-mode; TDI and 2DTT; RT-Elasto; BbH tissue & contrast; RT-3D-tissue and contrast; freehand 3D
<b>Scan format</b>	Sector, linear, convex, trapezoid, ext. Field of View
<b>Transducer inputs</b>	4 active ports

### Highlights

- Unique ergonomic design for wide applications range
- AutoIMT, NT, eTracking and WI, contrast analysis
- Hi-Freq compound probe for MSK and SmallPart
- New eFlow morphological tool for high sensitivity microvascular map
- eTracking /Wave Intensity for easy artery stiffness assessment



## Hitachi Aloka · ARIETTA V70

<b>Mode</b>	B & M-mode; free angle M-mode; PW and CW Doppler; Triplex; Dual Gate Doppler; TDI; color and power Doppler; eFlow-Flow Emphasis; Elastography; Contrast Harmonic Imaging; Free Hand 3D; 4D; Real-time Virtual Sonography
<b>Scan format</b>	Sector, linear and convex array, 360° electronic radial scanning, trapezoid, B-steer, dual imaging, Dual Slow-Motion Display, Wideview panoramic, HI-Definition Zoom, pan Zoom; Picture in Picture
<b>Transducer inputs</b>	4 active ports

### Highlights

- Light weight multi-disciplinary platform with ergonomic design
- Symphonic Technologies underpin outstanding image quality
- High quality 21" IPS-PRO monitor
- Wide range of standard & specialist transducers
- Advanced modalities & analysis: Strain Elastography, Contrast agent imaging, Real-time Virtual Sonography, Time Intensity Curve, eTracking /Wave Intensity, Eyeball EF, 2D Tissue Tracking



## Hitachi Aloka · ARIETTA V60

<b>Mode</b>	B & M-mode; free angle M-mode; PW and CW Doppler; Triplex; Dual Gate Doppler; TDI; color and power Doppler; eFlow-Flow Emphasis; Elastography; Contrast Harmonic Imaging; Free Hand 3D; 4D
<b>Scan format</b>	Sector, linear and convex array, 360° electronic radial scanning, trapezoid, B-steer, dual imaging, Dual Slow-Motion Display, Wideview panoramic, HI-Definition Zoom, pan Zoom; Picture in Picture
<b>Transducer inputs</b>	3 active ports

### Highlights

- Light weight compact multi-disciplinary platform with ergonomic design
- Symphonic Technologies underpin outstanding image quality
- High quality 17" IPS-PRO-LCD
- Wide range of transducers include interventional guidance, urology and TEE applications
- Advanced modalities & analysis: Strain Elastography, Contrast agent imaging, Time Intensity Curve, eTracking /Wave Intensity, 2D Tissue Tracking



## Hitachi Aloka · HI VISION Preirus

<b>Mode</b>	B & M-mode; omnidirectional M-mode; PW and CW Doppler; Dual Gate Doppler; color and power Doppler; FineFlow mode; triplex; TDI; real-time tissue elastography; contrast harmonic imaging; freehand 3D; 4D; Real-time Virtual Sonography; realtime Bi-plane
<b>Scan format</b>	Sector, linear and convex array, 360° electronic radial scanning, trapezoid, B-steer, dual imaging, WideView panoramic, HI-Definition Zoom, pan Zoom; Picture in Picture
<b>Transducer inputs</b>	3 active ports

### Highlights

- 3 types tissue harmonic imaging (6 frequencies)
- Award-winning, unique ergonomic design with increased system flexibility
- Tissue adaptive filtering, HI Rez+ (8 levels) for speckle and noise reduction
- Compound imaging, HI Com (from multiple directions and different frequencies)
- Graphical user interface with smart tab menus, image thumbnails and touchscreen panel for image optimisation



## Hitachi Aloka · ProSound Alpha 7

<b>Mode</b>	B & M-mode; free angle M-mode; PW and CW Doppler; color and power Doppler; eFlow; DDD; triplex-mode; TDI; RT-Elasto; BbH tissue & contrast; RT-3D; freehand 3D
<b>Scan format</b>	Sector, linear and convex array, trapezoid, extended Field of View, 360° Scanning
<b>Transducer inputs</b>	3 active ports

### Highlights

- Powerful, friendly and compact for wide range applications
- Auto IMT, NT, eTracking and WI, contrast analysis
- Sound velocity control for a perfect focused HD image
- Wide vascular features range for easy definition of peripheral stenotic vessels
- eTracking /Wave Intensity for easy artery stiffness assessment





**Hitachi Aloka · HI VISION Avius**

**Mode** B & M-mode; omnidirectional M-mode; PW and CW Doppler; color and power Doppler; FineFlow-mode; triplex; TDI; real-time tissue elastography; contrast harmonic imaging; freehand 3D; 4D; simultaneous Bi-plane

**Scan format** Sector (phased), linear and convex array, 360° electronic radial scanning, trapezoid, B-steer, dual imaging, Wide-View panoramic, HI-Definition Zoom, pan Zoom; Picture in Picture

**Transducer inputs** 3 active ports

**Highlights**

- 3 types tissue harmonic imaging (6 choice of frequencies)
- Tissue adaptive filtering, HI Rez+ (8 levels) for speckle and noise reduction
- Compound imaging, HI Com (from multiple directions and different frequencies)
- Graphical user interface incorporating smart tab menus, image thumbnails for image optimisation
- PSS, patient specific scanning selector



**Hitachi Aloka · ProSound Alpha 6**

**Mode** B & M-mode; free angle M-mode; PW and CW Doppler; color and power Doppler; eFlow; DDD; triplex-mode; TDI; broadband tissue & contrast harmonic; RT-3D; freehand 3D

**Scan format** Sector, linear and convex array, trapezoid, ext. Field of View

**Transducer inputs** 3 active ports

**Highlights**

- Powerful, friendly and compact for wide range applications
- Automated measurement for IMT, NT, eTracking and WI, contrast analysis
- Full control of sound velocity for a perfect focused imaging
- Wide range of features for Women's Health and perinatal imaging
- eTracking/Wave Intensity for easy artery stiffness assessment



**Hitachi Aloka · Noblus**

**Mode** B & M-mode; omnidirectional M-mode; PW and CW Doppler; color and power Doppler; FineFlow mode; triplex; TDI; real-time tissue elastography; contrast harmonic imaging; Freehand 3D; 4D; simultaneous Bi-plane

**Scan format** Sector, linear and convex array, 360° electronic radial scanning, trapezoid, B-steer, dual imaging, WideView panoramic, HI-Definition Zoom, pan Zoom

**Transducer inputs** Up to 3 active ports

**Highlights**

- Uses high-end technology migrated from HI VISION platforms
- Wide range of compatible transducers for many different clinical applications
- Premium image quality and advanced functions
- Flexibly designed in the form of a laptop PC with optional cart
- Unique space-saving design
- Tilt and swivel monitor
- Smart Touch feature for parameter adjustment by direct touch on image screen



**Hitachi Aloka · F37**

**Mode** B & M-mode; free angle M-mode; PW and CW Doppler; color and power Doppler; eFlow; DDD; triplex-mode; TDI; Broadband tissue Harmonic; RT-3D; freehand 3D, Freehand Color 3D

**Scan format** Sector, linear, convex, trapezoid, compound, AIP, ext. Field of View

**Transducer inputs** 3 active ports

**Highlights**

- Easy and compact for wide applications range
- 4D Shading
- Spatial Compound Imaging
- Trapezoid scan
- Adaptive Image Processing (AIP)
- Silky Image Processing (SIP)
- Needle Emphasis
- Dynamic Slow-Motion Display
- Automated measurement for IMT, NT, Free Angle M-mode
- DICOM SR and Raw Data



**Hitachi Aloka · F31**

**Mode** B & M-mode; free angle M-mode; PW and CW Doppler; color and power Doppler; eFlow; DDD; triplex-mode; TDI; Broadband tissue Harmonic; freehand 3D, Freehand Color 3D

**Scan format** Sector, linear, convex, trapezoid, compound, AIP, ext. Field of View

**Transducer inputs** 3 active ports

**Highlights**

- Easy and compact for wide applications range
- Spatial Compound Imaging
- Trapezoid scan
- Adaptive Image Processing (AIP)
- Dynamic Slow-Motion Display
- Automated measurement for IMT, NT, Free Angle M-mode
- DICOM SR and Raw Data



**Hitachi Aloka · iVu SOFIA – Automated Whole Breast Ultrasound System**

**Mode** Review using radial 2D, 3D, and MPR images

**Scan format** Radial scanning

**Transducer inputs** 92 mm linear transducer, frequency range 5 – 13 MHz

**Highlights**

- Rapid automated bilateral whole breast image acquisition (<1 min / breast)
- Compatible with Noblus and 92 mm Broad Band Linear Transducer, Frequency Range: 5 – 13 MHz
- Adjunct to mammography for dense breast patients
- Whole breast imaging for patients where mammography is contraindicated
- Identification of bilateral and multi-focal disease
- Comfortable exam in prone position, radial image acquisition



**Konica Minolta · Sonimage HS1**

**Mode** B-mode, M-mode, Color Doppler Mode, Power Doppler Mode, Pulsed Wave Mode, Continuous Wave Mode, Triplex Mode, Tissue Harmonics Imaging (THI), Auto IMT

**Scan format** Linear, convex

**Weight** 7.8 kg

**Highlights**

- Triad Tissue Harmonic Imaging
- SNV – Simple Needle Visualization
- Newly developed multi-frequency probes up to 18 Mhz
- Portable system with built-in battery
- Start-up from standby in just 15 seconds
- Excellent for MSK/ orthopaedic, nerve, vascular and general point-of-care imaging
- Full touchscreen 15" IPS high resolution monitor with innovative touch controls
- Monitor 360° rotation



**RAD BOOK 2015**

Please visit us at [www.healthcare-in-europe.com](http://www.healthcare-in-europe.com)

**Mindray Medical · DC-8 Exp**

**Mode** B, C, M, PW, CW, Power (DirPower), TDI, CM (Color M), 4D

**Scan format** Single Crystal Convex, Single Crystal Phased Array, Matrix Linear, Phased array, convex, Linear, endo-cavity, convex volume, endo-cavity volume, Pedoff, TEE

**Transducer inputs** 1 – 16 MHz

**Highlights**

- Brand new imaging architecture for more powerful and intelligent processing
- Advanced transducer series for maximum penetration
- Encompass a comprehensive range of clinical exams including abdominal, OB/GYN and small parts
- Intelligent auto optimisation to achieve best imaging setting in one keystroke
- Standard workflow protocol to improve exam consistency and efficiency



**Mindray Medical · DC-8**

**Mode** B-mode, M-mode, color-mode, power-mode, PW/CW Doppler-mode

**Scan format** linear, convex, phased array, micro-convex, endo-cavity, 4D-volume

**Transducer inputs** 2 – 15 MHz

**Highlights**

- Touchscreen
- Elastography
- Free Xros M-mode: anatomic M-mode
- TDI
- IMT
- iNeedle: needle visualization enhancement
- 3D/4D-imaging
- iWorks: auto workflow protocol



**Mindray Medical · DC-70**

**Mode** B,C,M,PW,CW,Power(DirPower),TDI,CM(Color M),4D

**Scan format** Convex, Phased Array, Linear,endo-cavity, convex volume, endo-cavity volume, Pedoff

**Transducer inputs** 2 – 14 MHz

**Highlights**

- 10.4" Gesture sensitive touch screen designed to improve workflow
- Quality exams guaranteed by 3T transducer technology and Echo-enriched beamformer
- Obtain realistic view of the fetus via iLive technology
- MedSight, interactive app to transfer clinical images via iOS or android powered smart device
- Range of application specific auto measurement packages to improve productivity



**Mindray Medical · DC-7**

**Mode** B-mode, M-mode, color-mode, power-mode, PW/CW Doppler-mode

**Scan format** TEE, linear, convex, phased array, micro-convex, endo-cavity, 4D-volume

**Transducer inputs** 2 – 15 MHz

**Highlights**

- Touchscreen
- Free Xros M-mode: anatomic M-mode
- Stress Echo
- TDI and QA
- Free Xros CM: curved anatomic M-mode
- IMT
- 3D/4D-imaging



**Mindray Medical · DC-T6**

<b>Mode</b>	B / 2B / 4B, B / M, B / C, B / C / PW
<b>Scan format</b>	Convex, Linear, endo-cavity, convex volume
<b>Transducer inputs</b>	2 – 15 MHz



**Highlights**

- 3T transducer technology
- Octal beam formation, phase shift THI
- 4D-imaging with iPage function
- iNeedle: needle visualization enhancement
- TDI with quantitative analysis
- Free Xros CM: curved anatomic M-mode
- iPower: intelligent power solution with built-in battery
- iTouch: intelligent image optimization for B-, color- and PW-mode
- iZoom: automatically expand the image to full screen

**Mindray Medical · DC-N3**

<b>Mode</b>	B, C, M, PW, CW, Power (DirPower), TDI, CM (Color M), 4D
<b>Scan format</b>	Convex, Phased Array, Linear, convex volume, endo-cavity, Pedoff
<b>Transducer inputs</b>	2 – 14 MHz



**Highlights**

- Exceptional image quality to enhance diagnostic confidence
- 4D capability with various rendering modes and iPage (multi-slice imaging)
- Auto Intima-Media Thickness measurement, to deliver a reliable carotid analysis
- Tissue Doppler Imaging and Free Xros CM for comprehensive cardiac diagnosis
- iPower, iRoam and full DICOM compatibility providing you with state of the art connectivity

**Mindray Medical · M9**

<b>Mode</b>	B, C, M, PW, CW, Power (DirPower), TDI, CM (Color M)
<b>Scan format</b>	Single Crystal Phased Array, Linear, Phased array, convex, endo-cavity, Pedoff, TEE
<b>Transducer inputs</b>	1 – 14 MHz



**Highlights**

- Advanced premium level laptop style color Doppler offering easy handling and mobility
- Rich in technology such as 3T transducer with single crystal and high dynamic range flow
- Ideal shared-service solution suitable to be used within multiple clinical settings
- Intelligent workflow with iTouch (one key image optimisation)
- User-defined operation to improve work efficiency

**Mindray Medical · M7**

<b>Mode</b>	B-mode, M-mode, color-mode, power-mode, PW / CW Doppler-mode
<b>Scan format</b>	TEE, linear, convex, phased array, micro-convex, endo-cavity, 4D-volume
<b>Transducer inputs</b>	2 – 15 MHz



**Highlights**

- 15" LCD monitor
- Free Xros M-mode: anatomic M-mode
- Anatomic M-mode
- Stress Echo
- TDI and QA
- Free Xros CM: curved anatomic M-mode
- IMT
- iNeedle: needle visualization enhancement
- 3D / 4D-imaging

**Mindray Medical · DP-50**

<b>Mode</b>	B-mode, B / B-mode, 4B-mode, M-mode, B / M-mode
<b>Scan format</b>	linear, micro-convex, convex, trans-vaginal, trans-rectal, bi-plane
<b>Transducer inputs</b>	2 – 15 MHz



**Highlights**

- Sleek, streamlined, compact shape
- High resolution, wide-angle 15" LCD with tilt functionality for better viewing
- iBeam spatial compounding imaging
- Phase shift harmonic imaging
- iTouch auto optimization
- IMT auto measurement
- iStation patient information management system

**Mindray Medical · TE7**

<b>Mode</b>	B, C, M, PW, CW, Power (DirPower), CM (Color M)
<b>Scan format</b>	Convex, Phased array, Linear, endo-cavity, endo-cavity volume, Pedoff, TEE
<b>Transducer inputs</b>	2 – 14 MHz
<b>Weight</b>	2.5 kg



**Highlights**

- Touch enabled response providing simple control and setting optimization
- Touch-screen gestures such as pinch to zoom in or out
- 3 second boot up from standby and swift touch response of settings
- Equipped with efficiency-boosting features iNeedle, iZoom, iTouch and Smart Track
- Easy to transport and store, can be mounted on trolley, desktop table or wall

**SAMSUNG · ACCUVIX XG**

<b>Mode</b>	2D, M, Color, PD, DPDI, PW / CW, TDI / TDW, Color M, Anatomical M, 3D / 4D
<b>Scan format</b>	Convex, Linear, Phased, 3D / 4D, Pencil
<b>Transducer inputs</b>	3

**Highlights:**

- Improved image quality with multi-beamforming and S-Vue transducer
- Advanced imaging functions (DMR+, HDVI, DPDI)
- Elastography for cervix, breast, prostate (ElastoScan)
- Semi-automated fetal NT & IT measurement (Volume NT & IT)
- Convenient 3D functions (VSI, FAD, SFVI, Multi Volume Slice, Mirror View, Multi-OVIX, 3D OH)
- 19" monitor / 9" touch screen



**SAMSUNG · EKO 7**

<b>Mode</b>	2D, M, Color, PD, DPDI, PW / CW, TDI / TDW, Color M, Anatomical M
<b>Scan format</b>	Convex, Linear, Phased, Pencil
<b>Transducer inputs</b>	3

**Highlights:**

- Improved image quality with multi-beamforming and S-Vue transducer
- Advanced imaging functions (DMR+, DPDI)
- Features that meet the essential cardiovascular imaging needs (Strain 2.0 with bull's eye, Stress Echo)
- 4-way motorized TEE transducer
- Semi-automated intima-media thickness measurement (Auto IMT)
- 19" monitor / LCD display on control panel



**SAMSUNG · ACCUVIX A30**

<b>Mode</b>	2D, M, Color, PD, DPDI, PW / CW, TDI / TDW, Color M, Anatomical M, 3D / 4D
<b>Scan format</b>	Convex, Linear, Phased, 3D / 4D, Pencil
<b>Transducer inputs</b>	4

**Highlights:**

- Superb image quality with hybrid imaging engine and S-Vue transducer
- Advanced imaging functions (DMR+, HDVI, DPDI)
- Elastography for cervix, breast, thyroid (ElastoScan)
- Elasticity contrast index calculation tool for thyroid (E-Thyroid)
- Convenient 3D functions (FRV, FAD, SFVI, SmoothCut)
- Contrast-enhanced ultrasound (Low-MI)
- 23" LED monitor / 9" touch screen



**SAMSUNG · H60**

<b>Mode</b>	2D, M, Color, PD, S-Flow, PW / CW, Color M, Anatomical M, 3D / 4D
<b>Scan format</b>	Convex, Linear, Phased, 3D / 4D, Pencil
<b>Transducer inputs</b>	4

**Highlights:**

- Slim and compact design for better use of space
- Superb image quality with hybrid imaging engine and S-Vue transducer
- Advanced imaging function (ClearVision, S-Flow)
- Convenient 3D functions (XI-STIC, 3D XI)
- Needle guidance technology (Needle Mate, Beam Steer)
- Semi-automated bodymark tool (e-Motion Marker)
- 18.5" LED monitor / 10.1" touch screen / Digital TGC preset



**SAMSUNG · HM70A**

<b>Mode</b>	2D, M, Color, PD, S-Flow, PW / CW, 3D / 4D
<b>Scan format</b>	Convex, Linear, Phased, 3D / 4D, Pencil
<b>Transducer inputs</b>	3

**Highlights:**

- Laptop design to suit various diagnostic environments
- Advanced imaging functions (ClearVision, HDVI, S-Flow, SFVI)
- Elastography for cervix, breast (ElastoScan)
- Convenient 3D functions (3DXI, SFVI, MagiCut)
- Needle guidance technology (Needle Mate)
- Fast booting within 20 sec
- Full screen mode
- 15" LED monitor / Optional cart (3 transducer ports / extended battery)



**SAMSUNG · PT60A**

<b>Mode</b>	2D, M, Color, PD, PW
<b>Scan format</b>	Convex, Linear, Phased
<b>Transducer inputs</b>	1

**Highlights:**

- Improved point-of-care usability with tablet design
- Advanced imaging functions (ClearVision)
- Needle guidance technology (Needle Mate)
- Semi-automated measurement of intima-media thickness (Auto IMT)
- 10.1" LED full touch screen monitor / Lightweight (3.6 kg) / Long battery time (80 Min)
- Optional cart (height-adjustable / 3 transducer ports / printer space)





**SAMSUNG · MySono U6**

**Mode** 2D, M, Color, PD, DPDI, PW / CW, 3D / 4D  
**Scan format** Convex, Linear, Phased, 3D / 4D, Pencil  
**Transducer inputs** 2

**Highlights:**

- Laptop design to suit various diagnostic environments
- Various live 3D / 4D ultrasound system (3D XI)
- Advanced imaging functions (DMR+, FSI, SRF)
- Needle guidance technology (Needle Mate)
- Extreme high dynamic range (200 dB)
- Continuous wave Doppler imaging
- High sensitive color and Doppler
- 15" LED monitor



**SAMSUNG · RS80A with Prestige**

**Mode** 2D, M, Color, PD, S-Flow, PW / CW, TDI / TDW, Color M, Anatomical M, 3D / 4D  
**Scan format** Convex, Linear, Phased, 3D / 4D, Pencil  
**Transducer inputs** 4

**Highlights:**

- Superb image quality through S-Vision architecture and S-Vue transducer
- Breast diagnostic guidance tool (S-Detect)
- Multi-modality fusion (S-Fusion)
- Shearwave with quantification (S-Shearwave)
- Needle guidance technology (Clear Track, Virtual Track, Needle Mate)
- Advanced arterial analysis tool
- 23" LED monitor / 13.3" tilting touch screen
- 6 way adjustable control panel



**SAMSUNG · SONOACE R3**

**Mode** 2D, M, Color, PD, PW, Color M  
**Scan format** Convex, Linear  
**Transducer inputs** 2

**Highlights:**

- Portability combined with essential imaging capabilities for various applications
- Advanced imaging functions (FSI, SRF)
- Workflow improving tool (QuickScan, shortcut key)
- Wide dynamic range
- 15" LED monitor
- Optional cart (height-adjustable / transducer holders / printer space)



**SAMSUNG · SONOACE R7**

**Mode** 2D, M, Color, PD, DPDI, PW / CW, TDI / TDW, Color M, Anatomical M, 3D / 4D  
**Scan format** Convex, Linear, Phased, 3D / 4D, Pencil  
**Transducer inputs** 3

**Highlights:**

- Slim and compact design for better use of space
- Improved image quality with multi-beamforming
- Advanced imaging functions (DMR+, DPDI)
- Elastography for cervix and breast (ElastoScan)
- Various live 3D / 4D ultrasound features (3D XI)
- Cardiac measurement solutions (Strain, Stress Echo)
- Semi-automated measurement of intima-media thickness (Auto IMT)
- 19" monitor



**SAMSUNG · SONOACE R5**

**Mode** 2D, M, Color, PD, PW, Color M  
**Scan format** Convex, Linear  
**Transducer inputs** 3

**Highlights:**

- Portability combined with essential imaging capabilities for various applications
- Advanced imaging functions (FSI, SRF)
- Workflow improving tool (QuickScan, shortcut key)
- Wide dynamic range
- 15" LED monitor
- Optional cart (height-adjustable / transducer holders / printer space)



**SAMSUNG · WS80A with Elite**

**Mode** 2D, M, Color, PD, S-Flow, PW / CW, Color M, Anatomical M, 3D / 4D  
**Scan format** Convex, Linear, Phased, 3D / 4D  
**Transducer inputs** 4

**Highlights:**

- Superb image quality through enhanced 3D imaging engine and S-Vue transducer
- Efficient diagnosis with 5D solutions (5D Heart, 5D CNS, 5D Follicle, 5D NT, 5D LB)
- Feature for sending ultrasound images to smartphone (Hello Mom)
- Elastography for breast with strain ratio (E-Breast)
- Advanced imaging functions (ClearVision, S-Flow)
- 23" LED monitor / 10.1" touch screen



## Siemens · ACUSON S3000 HELX Evolution

<b>Mode</b>	B-mode, color Doppler, power Doppler, PWDoppler (duplex, triplex), Doppler tissue imaging (color and PW), CW spectral Doppler, M-mode and color
<b>Scan format</b>	Doppler M-mode, curved array, phased array, linear, endocavity, 3D-/4D-imaging, pencil
<b>Transducer inputs</b>	3 micro-pinless + 1 park

### Highlights

- Excellent image quality, even in difficult patients
- Next generation HD transducer technology
- One-Click eSie Fusion – fusion imaging in seconds
- eSie Touch Elasticity Imaging
- The most comprehensive strain analysis toolbox including Virtual Touch Tissue IQ
- Advanced transducer technology including micro-pinless connectors, Hanafy lens and matrix arrays
- Contrast Pulse Sequence technology
- Automatic measurement of lesions with eSie Calcs native tracing software



## Siemens · ACUSON S2000 HELX Evolution

<b>Mode</b>	B-mode, color Doppler, power Doppler, PWDoppler (duplex, triplex), Doppler tissue imaging (color and PW), CW spectral Doppler, M-mode and color
<b>Scan format</b>	Doppler M-mode, curved array, phased array, linear, endocavity, 3D-/4D-imaging, pencil
<b>Transducer inputs</b>	3 micro-pinless + 1 park

### Highlights

- Excellent image quality, even in difficult patients
- Most comprehensive suite of transducers and exam types
- HD transducer technology
- eSie Touch Elasticity Imaging
- Virtual touch tissue imaging and tissue quantification
- Advanced transducer technology including micro-pinless connectors, Hanafy lens and matrix arrays
- Contrast Pulse Sequence technology
- Automatic measurement of lesions with eSie Calcs native tracing software
- ABVS automated breast volume scanning



## Siemens · ACUSON S2000 Automated Breast Volume Scanner



### Highlights

- Ideally suited to image patients with dense breast tissue and/or a history of breast disease
- Acquisition of full-field volumes of the breast automatically, quickly and comfortably
- Efficient and comprehensive analysis of the volume data
- Comprehensive BI-RADS reporting capabilities
- Patient friendly – minimal compression
- No radiation

## Siemens · ACUSON S1000 HELX Evolution

<b>Mode</b>	B-mode, color Doppler, power Doppler, PWDoppler (duplex, triplex), Doppler tissue imaging (color and PW), CW spectral Doppler, M-mode and color
<b>Scan format</b>	Doppler M-mode, curved array, phased array, linear, endocavity, 3D-/4D-imaging, pencil
<b>Transducer inputs</b>	3 micro-pinless + 1 park

### Highlights

- Premium performance at exceptional value
- Excellent image quality, even in difficult patients
- Most comprehensive suite of transducers and exam types
- Migration of clinically proven applications
- eSie Touch Elasticity Imaging, Virtual Touch technologies
- Advanced transducer technology including micro-pinless connectors, Hanafy lens and matrix arrays
- Contrast Pulse Sequence technology
- Automatic measurement of lesions with eSie Calcs native tracing software



## Siemens · ACUSON X700

<b>Mode</b>	B-mode, Phased and filtered THI, Color, Color velocity mode, power Doppler, Bidirectional power Doppler, pulse wave spectral Doppler mode (PW), continuous wave spectral Doppler (CW), duplex, triplex, M-mode incl. Color + Anatomical
<b>Scan format</b>	Curved, phased + linear array, endocavity, 3D-/4D-imaging
<b>Transducer inputs</b>	Supports micro-pinless and DL type connectors

### Highlights

- Excellent clinical performance with advanced imaging technologies
- Straightforward workflow features enable faster exams
- Innovative design and ergonomics facilitate improved user comfort and usability



## Siemens · ACUSON X600

<b>Mode</b>	B-mode, Phased and filtered THI, Color, Color velocity mode, power Doppler, Bidirectional power Doppler, pulse wave spectral Doppler mode (PW), continuous wave spectral Doppler (CW), duplex, triplex, M-mode incl. Color & Anatomical
<b>Scan format</b>	High density phased array, curved array and linear array, 2D
<b>Transducer inputs</b>	3 DL (260) type connectors

### Highlights

- Dynamic TCE tissue contrast enhancement reduces speckle
- TGO tissue grayscale optimization automatically adjusts image brightness and equalizes image gain
- SieClear multi-view spatial compounding uses multiple lines of sights to increase contrast resolution and improve tissue differentiation of low contrast lesions by reducing image speckle
- 20" LED monitor supports advanced imaging
- QuikStart Rapid Boot to enhance efficiency before, during, and after procedures



**Siemens · ACUSON X300 Premium Edition**

**Mode** B-mode, Color M-mode, M-mode, color Doppler velocity mode, power Doppler mode, pulsed wave spectral Doppler mode (PW), continuous wave spectral Doppler mode (CW), duplex mode, triplex mode

**Scan format** Curved array, phased array, linear, endocavity, 3D-/4D-imaging

**Transducer inputs** 3

**Highlights**

- Excellent imaging performance through excellent detail and contrast resolution
- High temporal resolution in 2D
- TGO tissue grayscale optimization technology for more consistent image quality
- High quality 4D imaging through advanced four sight technologies
- Exceptional clinical performance across a variety of applications and patient body types
- Easy-to-use ErgoDynamic imaging system design



**Siemens · ACUSON X300**

**Mode** B-mode, Color M-mode, M-mode, color Doppler velocity mode, power Doppler mode, Pulsed Wave (PW) spectral Doppler mode, CW continuous wave spectral Doppler mode

**Scan format** Phased array, curved array, endocavity, linear array

**Transducer inputs** 3

**Highlights**

- Hanafy lens transducer technology
- Tissue harmonic imaging
- DTI Doppler tissue imaging capability
- Multi-beam formation technology
- Streamlined clinical workflow with integrated DIMAQ-IP workstation, a user customizable control panel, and TGO tissue grayscale optimization technology
- ErgoDynamic imaging system design with flat panel display and articulating arm



**Siemens · ACUSON X150**

**Mode** B-mode, M-mode, color Doppler velocity mode, power Doppler mode, Pulsed Wave (PW) spectral Doppler mode, duplex mode, triplex mode, phased array, curved

**Scan format** Array, endocavity, linear array

**Transducer inputs** 2 + 1 optional

**Highlights**

- Top diagnostic performance and scalability
- Superior 2D-mode imaging
- Color imaging option
- Cardiac screening option and phased array transducer fully integrate 3-Scape real-time 3D imaging during freehand acquisition



**Siemens · ACUSON Freestyle**

**Mode** B-mode, Color Doppler, power Doppler

**Scan format** Curved array, linear array

**Transducer inputs** Wireless

**Highlights**

- World's first wireless transducer Ultrasound system
- Excellent image quality
- System design optimized for needle procedures
- Wireless transducers can be disinfected, sterilized or covered in a sterile bag
- Comprehensive automatic image optimization for easy system operation
- Perfect solution for Point of Care applications



**SIUI · Apogee 5800**

**Mode** B-mode, M-mode, CFM / CPA / DPA-mode, TDI-mode, PWD-mode, CW-mode, TDI-mode, Anatomic M mode, 3D / 4D, E-mode

**Scan format** 4D volume, linear, convex, phased array, micro-convex, trans-vaginal, trans-rectal, bi-plane

**Transducer inputs** 6

**Highlights**

Magnificent and brilliant, choice for genius

- Ultracloud – unprecedented Cloud experience
- MFI / VS-Flow / ECG
- 4D Pro (optional)
- Nanoview (Speckled Reduction)
- XBeam (Compound Imaging)
- Panoscope (Panoramic Imaging)
- SonoAir (Transmit images to iPad / iPhone or the wireless Printer)



**SIUI · Apogee 5500**

**Mode** B-mode, M-mode, CFM / CPA / DPA-mode, TDI-mode, PWD-mode, CW-mode, TDI-mode, Anatomic M mode, 3D / 4D, E-mode

**Scan format** 4D volume, linear, convex, phased array, micro-convex, trans-vaginal, trans-rectal, bi-plane

**Transducer inputs** 4

**Highlights**

Graceful and intelligent, redefine the standard

- Ultracloud – unprecedented Cloud experience
- MFI / VS-Flow / ECG
- 4D Pro (optional)
- Nanoview (Speckled Reduction)
- XBeam (Compound Imaging)
- Panoscope (Panoramic Imaging)
- SonoAir (Transmit images to iPad / iPhone or the wireless printer)



**SIUI · Apogee 5300 Touch**

**Mode** B-mode, M-mode, CFM/CPA/DPA-mode, PWD-mode, CW-mode, TDI-mode, Anatomic M mode, 3D/4D, E-mode

**Scan format** 4D volume, linear, convex, phased array, micro-convex, trans-vaginal, trans-rectal, bi-plane

**Transducer inputs** 4



**Highlights**

- MFI 7/VS-Flow/ECG
- 4D Pro (optional)
- Nanoview (Speckled Reduction)
- XBeam (Compound Imaging)
- Panoscope (Panoramic Imaging)
- SonoAir (Transmit images to iPad/iPhone or the wireless printer)

**SIUI · Apogee 5300 Omni**

**Mode** B-mode, M-mode, CFM/CPA/DPA-mode, PWD-mode, CW-mode, TDI-mode, Anatomic M mode, 3D/4D

**Scan format** 4D-volume, linear, convex, micro-convex, trans-vaginal, trans-rectal

**Transducer inputs** 4



**Highlights**

- MFI/ECG/Stress echo/Color M mode
- Auto IMT (intima-media thickness) measurement
- 4D Lite (optional)
- Nanoview (Speckled Reduction)
- XBeam (Compound Imaging)
- Panoscope (Panoramic Imaging)
- SonoAir (Transmit images to iPad/iPhone or the wireless printer)

**SIUI · Apogee 3800 Touch**

**Mode** B-mode, M-mode, CFM/CPA/DPA-mode, PWD-mode, 3D/4D, E-mode

**Scan format** 4D volume, linear, convex, micro-convex, trans-vaginal, trans-rectal, bi-plane

**Transducer inputs** 4



**Highlights**

- Wideband-beam emission technology
- Nanoview (Speckle Reduction)
- XBeam (Compound Imaging)
- Smart GSC (Grey Scale Enhancement)
- Panoscope (Panoramic Imaging)
- Auto IMT (intima-media thickness) measurement
- Sonoair (Transmit images to iPad/iPhone or the wireless printer)

**SIUI · Apogee 3800 Omni**

**Mode** B-mode, M-mode, C-mode, PWD/CWD-mode, TDI mode, Color M-mode, 3D/4D

**Scan format** 4D-volume, linear, convex, micro-convex, trans-vaginal, phase array

**Transducer inputs** 4



**Highlights**

- Frequency spectrum compound imaging
- Broadband harmonic imaging
- Multi-beam forming technology
- Adaptive speckle reduction technology
- Spatial compound imaging
- Accurate doppler flow imaging
- Complete cardio-vascular kits

**SIUI · Apogee 3500 Touch**

**Mode** B-mode, M-mode, CFM/CPA/DPA-mode, PWD-mode, CW mode, 3D/4D, E-mode

**Scan format** 4D volume, linear, convex, micro-convex, trans-vaginal, phased array, trans-rectal, bi-plane

**Transducer inputs** 4



**Highlights**

- XBeam (Compound Imaging)
- Wideband-beam emission technology
- Nanoview (Speckle Reduction)
- Panoscope (Panoramic Imaging)
- Penetration exam mode
- 19" LCD monitor

**SIUI · Apogee 3500 Omni**

**Mode** B-mode, M-mode, C-mode, PWD/CWD-mode, TDI mode, Color M-mode, Stress echo, 3D/4D

**Scan format** 4D-volume, linear, convex, micro-convex, trans-vaginal, phase array

**Transducer inputs** 4



**Highlights**

- Frequency spectrum compound imaging
- Broadband harmonic imaging
- Adaptive speckle reduction technology
- Advanced cardio-vascular kits
- Intelligent optimization
- Smart image mode display
- 17" high resolution medical LCD



**SIUI · Apogee 1000**

**Mode** B-mode, M-mode, C-mode, PWD-mode, TDI-mode, CW-mode, Anatomic M mode  
**Scan format** Linear, convex, phased array, micro-convex, trans-vaginal, trans-rectal, bi-plane  
**Transducer inputs** 1



**Highlights**

- Portable wisdom facilitate your diagnosis
- Ultracloud – unprecedented Cloud experience
  - MFI/VS-Flow/ECG
  - Nanoview (Speckled Reduction)
  - XBeam (Compound Imaging)
  - Panoscope (Panoramic Imaging)
  - SonoAir (Transmit images to iPad/iPhone or the wireless printer)

**SIUI · SIUI Apogee 1200 Touch**

**Mode** B-mode, M-mode, C-mode, PWD-mode, CW-mode, 3D/4D, E-mode  
**Scan format** 4D-volume, linear, convex, phased array, micro-convex, trans-vaginal, trans-rectal, bi-plane  
**Transducer inputs** 2



**Highlights**

- Fusion Freq
- Wideband-beam emission technology
- XBeam (Compound Imaging)
- Smart GSC (Grace Scale Enhancement)
- Smart elastography for breast exams
- Advanced 4D experience in OB/GYN
- Panoscope (Panoramic Imaging)
- Auto IMT (intima-media thickness) measurement

**SIUI · Apogee 1200 Omni**

**Mode** B-mode, M-mode, C-mode, PWD/CWD-mode, TDI mode, Color M-mode, Stress echo, 3D/4D  
**Scan format** 4D-volume, linear, convex, micro-convex, trans-vaginal, phase array  
**Transducer inputs** 2



**Highlights**

- Frequency spectrum compound imaging
- Broadband harmonic imaging
- Adaptive speckle reduction technology
- Accurate color flow imaging
- Smart cardio-vascular clinical kits
- External 15" high resolution LCD with smart trolley

**SIUI · CTS-8800Plus Color**

**Mode** B-mode, M-mode, C-mode, PWD mode, 3D/4D, THI  
**Scan format** 4D-volume, linear, convex, micro-convex, trans-vaginal, trans-rectal  
**Transducer inputs** 2



**Highlights**

- Speckle reduction technology
- Spatial compound imaging
- 4D Lite(Optional)
- 15" medical LCD

**SIUI · CTS-7700Plus**

**Mode** B-mode, M-mode, PWD mode, 3D, THI  
**Scan format** Linear, convex, micro-convex, trans-vaginal, trans-rectal, bi-plane  
**Transducer inputs** 2



**Highlights**

- Speckle reduction technology
- Spatial compound imaging
- Trapezoidal Imaging
- Smart one key optimization
- Built-in lithium battery
- 12" medical LCD

**SIUI · CTS-5500Plus**

**Mode** B-mode, M-mode, Zoom B mode, THI  
**Scan format** Linear, convex, micro-convex, trans-vaginal, trans-rectal  
**Transducer inputs** 2



**Highlights**

- Powerful digital beamforming technology
- Unique high-definition zooming function
  - IP one-key optimization
  - 10" medical LCD

**SIUI · Apogee 1200V**

<b>Mode</b>	B-mode, M-mode, C-mode, PWD-mode, 3D / 4D, Anatomical M Mode, Color M mode
<b>Scan format</b>	4D-volume, linear, convex, micro-convex, trans-vaginal, phase array
<b>Transducer inputs</b>	2



**Highlights**

- Anatomical M Mode
- Color M Mode
- ECG Module
- Compound Imaging
- Panoramic Imaging
- Automatic Optimization (B, PW mode)
- Speckled Reduction
- Continuous Wave Doppler mode (CWD)
- 4D Imaging
- Edit the exam type and save the user-defined items

**SIUI · CTS-800**

<b>Mode</b>	B mode, B / M mode, M mode, Zoom B mode
<b>Scan format</b>	Linear, Convex, Micro-convex, Linear (back fat)
<b>Transducer inputs</b>	1



**Highlights**

- Gravity Sensor
- Grid for estimation
- Battery
- Video glasses (Optional)
- Palm size design
- 7-inch WVGA LCD monitor
- Environmental rating:
  - IP 54 (main unit)
  - IP 67 (probe head)

**Sonoscape · S40**

<b>Mode</b>	B-mode, M-mode, 2B-mode, 4B-mode, CFM, PDI, TDI, PW, CW, 3D, 4D
<b>Scan format</b>	Linear, Convex, Micro-convex, Endocavity, Phased Array, Intraoperative, TEE, Bi-plane, Pencil, Volumetric, Endocavity 4D and Laparoscope probe
<b>Transducer inputs</b>	5 + 1



**Highlights**

- 19" high definition LCD monitor
- 10" touch screen with 15° adjustable angle
- Height and position adjustable control panel
- Additional endocavity probe holder and gel warmer
- TDI, stress echo and elastography

**Sonoscape · S30**

<b>Mode</b>	B-mode, M-mode, 2B-mode, 4B-mode, CFM, PDI, TDI, PW, CW, 3D, 4D
<b>Scan format</b>	Linear, Convex, Micro-convex, Endocavity, Phased, Intraoperative, TEE, Bi-plane, Pencil, Volumetric and Endocavity 4D probe
<b>Transducer inputs</b>	5



**Highlights**

- 19" high definition LCD monitor with wide viewing angle
- 10" touch screen
- Height adjustable control panel
- Speckle reduction and compound imaging technologies
- Excellent application technology: 4D, real-time panoramic, triplex, IMT, Color M-mode, Steer M-mode, TEL Index, TDI
- Full patient database and image management solutions: DICOM 3.0, AVI / JPG, USB 2.0, HDD, DVD, PDF report

**Sonoscape · S22**

<b>Mode</b>	B-mode, M-mode, THI, CDI, DPI, TDI, PW, CW, HPRF, 3D / 4D, Color M-mode, Steer M-mode, Panoramic imaging
<b>Scan format</b>	Linear, Convex, Micro-convex, Endocavity, Phased Array, Intraoperative, TEE, Bi-plane, Pencil, Volumetric
<b>Transducer inputs</b>	4 + 1



**Highlights**

- 18.5" high resolution widescreen LED
- 8" touch screen
- Premium application technology: 4D,  $\mu$ -scan, compound imaging, Pulse Inversion Harmonic Imaging, Color M-mode, Steer M-mode, PDI, TDI, Real-time Panoramic, Trapezoid, Auto-IMT, Stress Echo
- Full patient database and image management solutions: DICOM 3.0, AVI / JPG, USB2.0, HDD, DVD, PDF report
- Multi-language Input Keyboard

**Sonoscape · S12**

<b>Mode</b>	B-mode, M-mode, THI, CDI, DPI, TDI, PW, CW, HPRF, 3D / 4D, Color M-mode
<b>Scan format</b>	Linear, Convex, Micro-convex, Endocavity, Phased Array, Bi-plane, Volumetric
<b>Transducer inputs</b>	4



**Highlights**

- 15" LED monitor with articulating arm
- Premium application technology:  $\mu$ -scan, Pulse Inversion Harmonic Imaging, Real-time Panoramic Imaging, Trapezoid Imaging, Auto-IMT, Triplex
- Full patient database and image management solutions: DICOM 3.0, AVI / JPG, USB2.0, HDD, DVD, PDF report
- Build-in Battery

Sonoscape · SSI-6000

**Mode** B-mode, M-mode, THI, TDI, CDI, PDI, TDI, PW, CW, 3D/4D, Color M-mode, Steer M-mode  
**Scan format** Linear, Convex, Phased Array, Transvaginal, Transrectal, Bi-plane and Intraoperative Probe  
**Transducer inputs** 3

**Highlights**

- 17" high resolution LCD monitor
- 200° field of view with temperature-detection technology for transvaginal transducers
- μ-scan, THI, TDI and M-tuning one-touch optimization
- Full patient database and image management solutions: DICOM 3.0, AVI / JPG, USB2.0, HDD, DVD, PDF report



Sonoscape · S9

**Mode** B-mode, M-mode, 2B-mode, 4B-mode, CFM, PDI, TDI, PW, CW, 3D, 4D  
**Scan format** Linear, Convex, Micro-convex, Endocavity, Phased Array, Intraoperative, TEE, Bi-plane, Pencil, Volumetric, Endocavity 4D and Laparoscope probe  
**Transducer inputs** 2

**Highlights**

- 15" LCD with 50° adjustable angle
- Smart full touch panel with 140° convertible open angle
- TDI, Stress Echo and Elastography
- Built-in battery ensures 90 minutes scanning
- Stylish trolley with abundant accessories



Sonoscape · S9 Pro

**Mode** B-mode, M-mode, 2B-mode, 4B-mode, CFM, PDI, TDI, PW, CW, 3D / 4D  
**Scan format** Linear, Convex, Micro-convex, Endocavity, Phased Array, Intraoperative, TEE, Bi-plane, Pencil, Volumetric, Endocavity 4D and Laparoscope Probe  
**Transducer inputs** 2

**Highlights**

- 15" LCD with 50° adjustable angle
- Smart full touch panel with 140° convertible open angle
- TDI, Stress Echo and Elastography
- Built-in battery ensures 90 minutes scanning
- Stylish trolley with abundant accessories



Sonoscape · S8EXP

**Mode** B-mode, M-mode, 2B-mode, 4B-mode, 3D / 4D, CFM, PDI, PW  
**Scan format** Linear, Convex, Micro-convex, Endocavity, Phased, Intraoperative, TEE, Bi-plane, Pencil, Volumetric and Endocavity 4D probe  
**Transducer inputs** 2

**Highlights**

- 15" LCD with 50° adjustable angle
- Speckle reduction and compound imaging technologies
- Advanced application technology: 4D, real-time panoramic, triplex, IMT, color M-Mode, steer M-mode, TEI index, TDI and stress echo
- Full patient database and image management solutions: DICOM 3.0, AVI / JPG, USB2.0, HDD, PDF report
- Removable Built-in battery with 90 minutes scanning capability



Sonoscape · S8

**Mode** B-mode, M-mode, 2B-mode, 4B-mode, CFM, PDI, TDI, PW, CW, 3D, 4D  
**Scan format** Linear, Convex, Micro-convex, Endocavity, Phased Array, Intraoperative, Bi-plane, Volumetric  
**Transducer inputs** 2

**Highlights**

- High density transducers with frequency ranges from 1.9 to 15 MHz
- μ-scan, IMT, B-Steer, multiple-beam processing, automatic flow volume analysis
- TDI, Steer M, Color M; CW, HPRF
- Built-in high capacity lithium battery



Sonoscape · S6

**Mode** B-mode, M-mode, 2B-mode, 4B-mode, 3D / 4D, CFM, PDI, PW  
**Scan format** Convex, Micro-convex, Endocavity, Phased Array, Linear, Bi-plane, Intra-operative, Volumetric  
**Transducer inputs** 2

**Highlights**

- Full patient database solutions: DICOM 3.0, AVI / JPG, USB 2.0, HDD, PDF report
- Built-in high capacity lithium battery



**Sonoscape · S2**

<b>Mode</b>	B-mode, M-mode, 2B-mode, 4B-mode, CFM, PDI, PW, 4D
<b>Scan format</b>	Linear, Convex, Phased Array, Micro-convex
<b>Transducer inputs</b>	2



**Highlights**

- Stable imaging technology:  $\mu$ -scan, compound imaging
- Brand new patient file management speeds up your workflow
- Built-in battery supports you with 1 hour scanning
- Full patient database solution: DICOM 3.0, AVI / JPG, USB 2.0, HDD and PDF report

**Sonoscape · A8**

<b>Mode</b>	B-mode, B+M-mode, M-mode, 2B-mode, 4B-mode, THI
<b>Scan format</b>	Linear, Convex, Micro-convex, Bi-plane
<b>Transducer inputs</b>	3



**Highlights**

- High definition 15" LCD monitor with chroma function
- Compact cart design with articulating arm
- Intuitive operation with M-tuning one-key image optimization
- Clip-board function for quick patient image capture and review
- Full patient database and image management solutions: AVI / JPG, USB2.0, HDD, PDF report

**Sonoscape · A6**

<b>Mode</b>	B-mode, 2B-mode, 4B-mode, M-mode
<b>Scan format</b>	Linear, Convex, Micro-convex, Endocavity, Bi-plane
<b>Transducer inputs</b>	2



**Highlights**

- Adjustable 12" LCD monitor with chroma function
- Less than 6 kg, convertible design
- THI technology with Five Variable Frequency
- Built-in high capacity lithium battery

**Sonoscape · A5**

<b>Mode</b>	B-mode, 2B-mode, M-mode, B+M-mode
<b>Scan format</b>	Linear, Convex, Endovaginal
<b>Transducer inputs</b>	2



**Highlights**

- Adjustable 12" LCD monitor with chroma function
- Standard two active transducer sockets
- Multi-Frequency transducers
- THI, clip-board function and more
- Built-in high capacity Li-on battery (optional)
- Convertible with trolley

**SuperSonic Imagine · AIXPLORER**

<b>Mode</b>	B-mode, Color Flow, Power, Directional Power, PW Doppler, M-mode, Contrast, ShearWave Elastography (SWE), 3D B-mode, 3D SWE, UltraFast Doppler
<b>Scan format</b>	Linear, Convex, Endocavity, Micro-convex, Phased, Compact-linear, 3D, Panoramic, Dual, CEUS
<b>Transducer inputs</b>	4 Ports, over 100 Clinically Optimized Presets



**Highlights**

- Impeccable Image Quality
- Next-generation software-based UltraFast beamformer (20,000 fr / sec)
- Real-time Quantitative ShearWave Elastography in a full High-Res 2D area. Optimized on a wide range of probes and applications
- UltraFast Doppler: Full retrospective spectral analysis of multiple PW sample volumes simultaneously
- Outstanding ergonomics. Fast, reproducible, cost effective workflow

**Buy & sell used equipment on**



**www.dotmed.com**

**Over 400,000 listings**

**Over 20,000 daily visitors**



**Toshiba · Aplio 500**

**Mode** 2D-, 3D-, 4D-, M-mode, PW/CW Doppler, high PRF, color / power Doppler, ADF, SMI

**Scan format** Linear, convex, matrix and phased arrays; biopsy and 4D-volume probes, motorized TEE, endocavitary and pencil probes

**Transducer inputs** 4 + 1 (pencil)

**Highlights**

- High Density Beamformer, Precision Imaging, ApliPure+, Differential THI, TSO, ADF, Superb Micro Vascular Imaging
- 4D, CEUS; surface, MPR, MultiView, Luminance
- FlyThru virtual endoscopy, Smart Fusion, RT and Shearwave elastography, Acoustic Structure Quantification, MicroPure, Auto IMT, AUTO NT, Wall Motion Tracking
- Advanced CEUS incl. VRI, MicroFlow imaging and CEUS quantification



**Toshiba · Aplio 400**

**Mode** 2D-, 3D-, 4D-, M-mode, PW/CW Doppler, high PRF, color / power Doppler, ADF, SMI

**Scan format** Linear, convex and phased arrays; biopsy and 4D-volume probes, motorized TEE, endocavitary and pencil probes

**Transducer inputs** 4 + 1 (pencil)

**Highlights**

- High Density Beamformer, Precision Imaging, ApliPure+, Differential THI, TSO, ADF, Superb Micro Vascular Imaging
- Whole body 4D-imaging, CEUS; surface, MPR, MultiView, Luminance
- Realtime elastography, MicroPure, Auto IMT, Wall Motion Tracking, advanced CEUS contrast imaging incl. VRI and MicroFlow imaging
- iStyle+ with fully customizable console, Quick Start, Quick Scan and Quick Assist



**SonoScape**  
www.sonoscape.com

**S40**  
Style and Performance



2014 FROST & SULLIVAN  
COMPANY OF THE YEAR IN ULTRASOUND MARKET  
Presented To  
SONOSCAPE COMPANY LIMITED

2013 FROST & SULLIVAN  
ULTRASOUND MARKET GROWTH LEADERSHIP AWARDS  
Presented To  
SONOSCAPE COMPANY LIMITED

2008 FROST & SULLIVAN  
Entrepreneurial Company Award  
2009 FROST & SULLIVAN  
Product Quality Leadership Award

CE 0434

ISO 13485



Caring for Life through Innovation

**Toshiba · Aplio 300**

**Mode** 2D-, 3D-, 4D-, M-mode, PW/CW Doppler, high PRF, color / power Doppler, ADF

**Scan format** Linear, convex and phased arrays; biopsy and 4D-volume probes, motorized TEE, endocavitary and pencil probes

**Transducer inputs** 4 + 1 (pencil)

**Highlights**

- High Density Beamformer, Precision Imaging, ApliPure+, Differential THI, Tissue Enhancement, Advanced Dynamic Flow
- Whole body 4D-imaging; surface rendering, MPR, MultiView, Luminance
- Realtime elastography, Auto IMT, Auto NT, Wall Motion Tracking, CEUS contrast imaging
- iStyle+ productivity suite with fully customizable console, Quick Start, Quick Scan and Quick Assist



**Toshiba · Xario 200**

**Mode** 2D-, 3D-, 4D-, M-mode, PW/CW Doppler, high PRF, color / power Doppler, ADF

**Scan format** Linear, convex and phased arrays; biopsy and 4D-volume probes, motorized TEE, endocavitary and pencil probes

**Transducer inputs** 3 + 1 (pencil)

**Highlights**

- High Density Beamformer, Precision Imaging, ApliPure+, Differential THI, Tissue Enhancement, Advanced Dynamic Flow
- 4D-imaging; surface rendering, MPR, MultiView
- Realtime elastography, Auto IMT, Stress Echo, CEUS contrast imaging
- iStyle+ productivity suite with fully customizable panel, agile housing, height adjustable console, panel swivel, Quick Start, Quick Scan and Quick Assist



**Toshiba · Xario 100**

**Mode** 2D-, 3D-, 4D-, M-mode, PW/CW Doppler, high PRF, color / power Doppler, ADF

**Scan format** Linear, convex and phased arrays; biopsy and 4D-volume probes, motorized TEE, endocavitary and pencil probes

**Transducer inputs** 3 + 1 (pencil)

**Highlights**

- High Density Beamformer, Precision Imaging, ApliPure+, Differential THI, Tissue Enhancement, Advanced Dynamic Flow
- 4D-imaging; surface rendering, MPR, MultiView,
- Realtime elastography, Auto IMT, Panoramic View, Trapezoid Scan
- iStyle+ productivity suite with fully customizable panel, agile housing, height presettable console, Quick Start, Quick Scan and Quick Assist



**Toshiba · Viamo**

**Mode** 2D-, M-mode, spectral Doppler, high PRF, color / power Doppler, ADF

**Scan format** Linear, convex and phased arrays

**Transducer inputs** 2

**Highlights**

- Premium image quality
- 5 seconds bootup time
- Hybrid operation with touch screen and programmable panel
- Versatile mounting in desk-top, cart and tablet modes
- One-click workflow control
- TissuePure speckle reduction
- ApliPure realtime compound imaging



**ACCESSORIES / COMPLEMENTARY SYSTEMS**

**GCTechnology · CIRS Phantoms**



**Highlights**

- Fetal ultrasound phantom family
- Ultrasound heart phantom
- Quality assurance test phantoms
- Ultrasound Accreditation Phantoms
- Male and female ultrasound pelvic phantoms
- Prostate phantom family
- Breast phantom family
- Thyroid ultrasound training phantom
- Kidney training phantom
- Vascular access training phantom kit
- Shear Wave Liver Fibrosis Phantoms
- Elastography Phantoms

**RAD BOOK 2015**

Please visit us at [www.healthcare-in-europe.com](http://www.healthcare-in-europe.com)

# Testing Devices



IBA Dosimetry · 2-part PMMA CT-Phantom



**Highlights**

- Adult Head and Body/  
Pediatric Body VD1003110
- Phantom for CTDI measurements according to IEC 60601-2-44,  
IEC 61223-3-5, IEC 61223-2-6
- Consisting of:
  - 1 adult head-/pediatric body phantom, 16 cm diameter, 5 holes
  - 1 adult body annulus, 32 cm diameter, 4 holes
  - 9 acrylic rods for plugging all the phantom holes
  - 1 adapter for ionization chamber DCT10-RS/Lemo

IBA Dosimetry · Dosimax plus A



**Highlights**

PTB-approved single channel dosimeter according to IEC 61674, designed for acceptance tests and for quality checks at radiographic, fluoroscopic, dental and mammographic X-ray units

IBA Dosimetry · Dosimax plus A HV



**Highlights**

PTB-approved single channel dosimeter with internal high voltage supply according to IEC 61674 for use with ionization chamber DCT10-RS. Designed for measurements at CT

IBA Dosimetry · Dosimax plus Duo incl. Sandwich Detector DE2DX



**Highlights**

Dual-channel dosimeter especially for constancy tests at radiographic and fluoroscopic X-ray units with sandwich detector DE2DX. Entrance and exit dose / dose rate measurement with one single exposure

IBA Dosimetry · DSA Test Device incl. Carrying Case



**Highlights**

- For quality tests in digital subtraction angiography  
(IEC 61223-3-3 and DIN 6868-4, 2007)
- Test Parameters:
  - Dynamic range
  - Artifacts
  - DSA contrast sensitivity
  - Logarithmic check

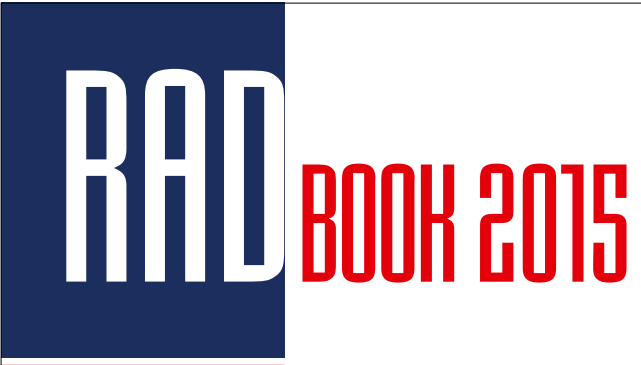

Please visit us at

[www.healthcare-in-europe.com](http://www.healthcare-in-europe.com)



IBA Dosimetry · IQ Analyzer Primus

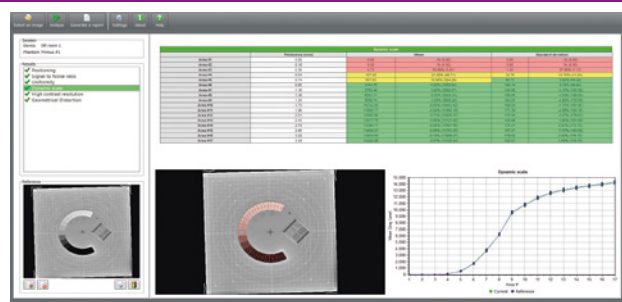

**Highlights**

- The IQ Analyzer Primus software performs fast, quantitative and reproducible constancy measurement on multiple imaging modalities.
- Select Images; Efficient loading of DICOM images
- Automatic Analysis; Image quality verification with quantitative and reproducible results in less than 10 seconds
- Convenient Reporting; Generate reports and archive in both PDF and Microsoft Excel formats

IBA Dosimetry · KermaX plus DDP “Single” – 120-DDP S



**Highlights**

- Duo-channel multifunctional dosimeter dedicated to measure DAP or DAP rate or exposure time in patient dose monitoring.
- One rectangular, transparent ionization chamber with integrated electronics and "Dual Line Display D" with two very bright LED display lines indicating either the DAP / DAP rate or exposure time
- The system provides two RS 232 interfaces (RIS / HIS and printer connection)

IBA Dosimetry · KermaX plus IDP – 120-IDP

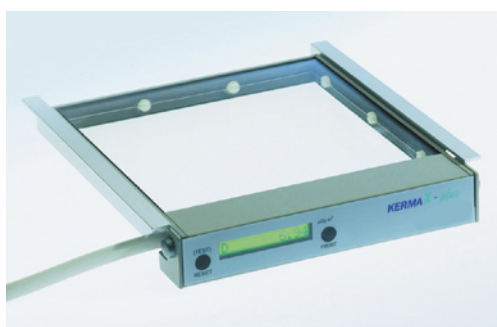

**Highlights**

- Ideal solution for a quick and convenient retrofit installation to measure DAP and DAP rate for patient dose monitoring.
- Rectangular, transparent ionization chamber with integrated electronics and a 10-digit internal background lighting LCD display; optional RS 232 / RS 485 for computer or printer interface
- Suitable for measurements in pediatric applications with a resolution of 0.01  $\mu\text{Gym}^2$

IBA Dosimetry · KermaX plus SDP – 120-SDP

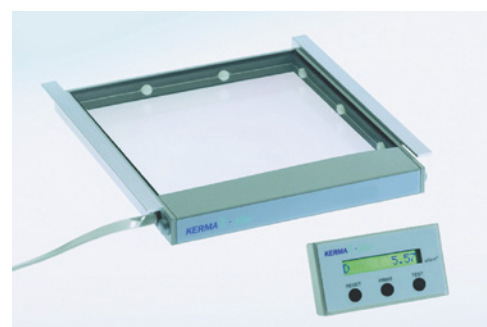

**Highlights**

- Easy to install standard dosimeter dedicated to measure DAP and DAP rate for patient dose monitoring.
- Rectangular, transparent ionization chamber with integrated electronics and a separate 10-digit background lighting LCD Single Line Display providing an RS 232 PC / Printer interface
- Suitable for measurements in pediatric applications due to its digital resolution of 0.01  $\mu\text{Gym}^2$

IBA Dosimetry · KermaX plus TinO IDP – 120-TinO-IDP

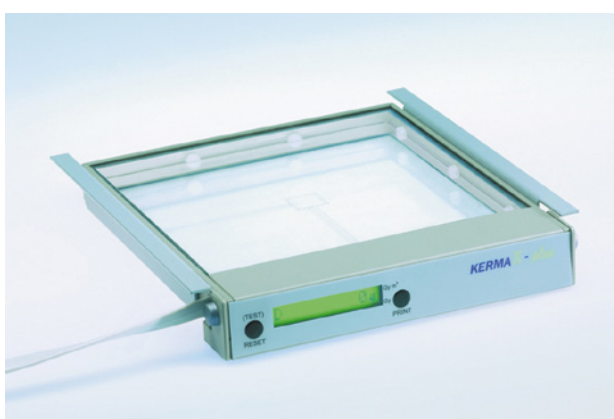

**Highlights**

Rectangular, transparent ionization chamber with integrated electronics, a 10-digit internal background lighting LC-Display, interface optionally

IBA Dosimetry · Multimeter MagicMaX Universal



**Highlights**

MagicMaX Universal detectors:

- RQA – single detector for rad, fluoro and dental
- RQM – single detector for mammo
- XM – multi-detector for rad and fluoro
- XM – multi-detector for mammography
- DCT10-MM and DCT30-MM ionization chambers for CT
- Measurement parameters: dose / dose rate and dose per pulse, non invasively practical peak voltage, exposure time, total filtration, first half value layer (HVL)

IBA Dosimetry · Test Device DIGI-13

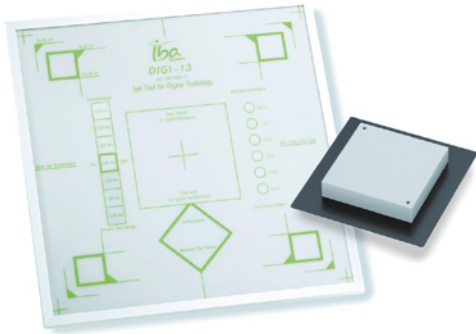

**Highlights**

- For quality checks at all types of CR/DR radiographic systems
- Test Parameters:
 

– Signal standardization	– Alignment of light and X-ray field
– Check of dose indicator	– Image scale
– homogeneity	– Artifacts
– Spatial and contrast resolution	– Geometry symmetry

IBA Dosimetry · Test Device ETR1 incl. Centering Tube

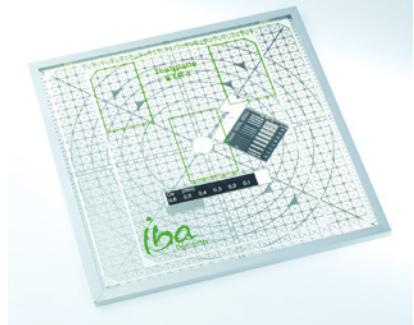

**Highlights**

- For quality checks in conventional radiography and fluoroscopy (DIN 6868-3, -4 and IEC 61223-2-9/-2-11)
- Test Parameters:
 

– Spatial resolution	– Contrast resolution
– Alignment of light and X-ray field	– Measuring areas for optional density
– Geometry symmetry	

IBA Dosimetry · Test Device Mammo-152

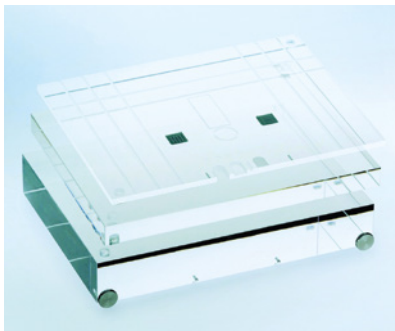

**Highlights**

- For acceptance and constancy tests (DIN V 6868-152, DIN EN 61223-3-2 and DIN 6868-7/EPQC (EUREF) in conventional mammography
- Test Parameters:
 

– Object thickness and tube voltage compensation resp. AEC reproducibility	– Spatial resolution
– Attenuation factor	– Contrast and image resolution
	– Artifacts / Geometry
	– Check of missed tissue at chest wall

IBA Dosimetry · Test device PASMAM 1054 A/C



**Highlights**

- 40 mm basic body with integrated Al step wedge with 14 steps from 0 to 5.2 mm
- 6 mm structural plate with recess for test inserts, 2 rows of steel balls with integrated turnable resolution test in line groups of 5, 6, 7, 8 and 10 Lp/mm
- Attenuation body 3 x 20/1 x 10/1 x 6 mm PMMA
- Various test inserts
- Carrying case

IBA Dosimetry · Test device PASMAM 1054 C



**Highlights**

- 40 mm base plate with integrated Al step wedge with 14 steps from 0 to 5.2 mm and 2 rows of steel balls for checking the image limitations towards the thorax side
- 6 mm structural plate with recess for test inserts, 2 rows of steel balls with integrated turnable resolution test in line groups of 5, 6, 7, 8 and 10 Lp/mm
- Various test inserts
- Carrying case - Attenuation body 2 x 20/2 x 10 mm

IBA Dosimetry · Test Device Primus L

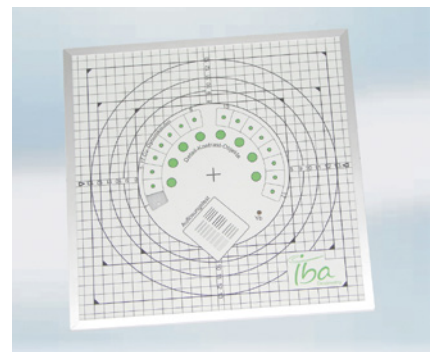

**Highlights**

- For quality checks at digital / conventional radiographic and fluoroscopic X-ray units (according to DIN 6868-4, 2007)
- Test Parameters:
 

– Spatial resolution	– Alignment of light and X-ray field
– Verification of used kV-range	– Geometry symmetry
– Contrast resolution	– Image scale, Dimensions: 300 x 300 x 18.5 mm

## PTW · NOMEX Dosimeter

**Highlights**

- Dosimetry system (CE marked, class IIb certified) fully compliant with IEC 61674
- Suitable for CTDI measurements acc. to IEC 60601-2-44 using a 300 or 100 mm CT ion chamber
- Provides for automatic air density correction for precise results
- Data / waveform export to Excel via USB or Bluetooth
- Accessories: CTDI head and/or body PHANTOMS (CE marked, class I certified)

## PTW · NOMEX System

**Highlights**

- Dosimetry system (CE marked, class IIb certified) acc. to IEC 61674
- Incl. NOMEX DOSEMETER and MULTIMETER (captures all dose values, time, kVp, TF, HVL, frequency, pulses, waveforms)
- Ionization chambers or semi-conductor detectors can be connected
- Data / waveform export to Excel via USB or Bluetooth
- Accessories: Test objects NORMI RAD / FLU, NORMI DSA, NORMI 3D (CE marked, class I certified)

Advanced X-ray  
Measurements  
Should be  
**EASY**

**RTI**

From Radiation to Information

World Headquarters  
RTI Electronics AB

Flojelbergsgatan 8 C  
SE-431 37 Mölndal, SWEDEN

E-mail: [sales@rti.se](mailto:sales@rti.se)  
[www.rti.se](http://www.rti.se)

Phone: + 46 31 746 36 00  
Fax: + 46 31 27 05 73

PTW · NOMEX Multimeter



**Highlights**

- Dosimetry system (CE marked, class IIb certified) acc. to IEC 61674
- Connection to a PC via USB
- Angular independent for positioning within the beam
- Fully automatic adjustment
- Single exposure captures all dose values, time, kVp, TF, HVL, frequency, pulses and waveforms
- Ideal for tomosynthesis measurements
- Data / waveform export to Excel via USB
- Accessories: NORMI MAM test objects

PTW · NOMEX System



**Highlights**

- Dosimetry system (CE marked, class IIb certified) acc. to IEC 61674
- Incl. NOMEX DOSEMETER and MULTIMETER (captures all dose values, kVp, TF, HVL, frequency, pulses, waveforms)
- Ionization chambers or semi-conductor detectors can be connected
- Data / waveform export to Excel via USB or Bluetooth
- Accessories: Test objects NORMI RAD / FLU, NORMI 3D, NORMI 13 (CE marked, class I certified)

# RAD

# BOOK 2015

Please visit us at

[www.healthcare-in-europe.com](http://www.healthcare-in-europe.com)

QUART · dent / digitest Dental QA / QC Test Phantom

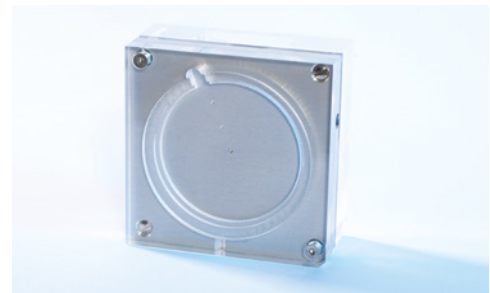

**Highlights**

- The QUART dent / digitest 2D dental imaging test phantom is designed to test parameters according to DIN and IEC QA / QC requirements.
- It features patient equivalent filtration and objects to perform full-scale x-ray image quality analyses.

**Parameters**

- Spatial resolution
- High-contrast resolution
- Low-contrast resolution
- Homogeneity / artefacts
- Radiation field / tube alignment

QUART · didoEASY Diagnostic X-Ray Meters



**Highlights**

- The QUART didoEASY meters are designed for quick measurements of dose, dose rate and exposure time in x-ray QA / QC and service.
- The EASY meters automatically compensate all radiation qualities in their area of application. Three meter versions are available: for R / F and Dental (40 – 160 kV), for Mammography (25 – 40 kV), and one for the full diagnostic range (25 – 160 kV).

QUART · dido2000 Series Diagnostic X-Ray Meters



**Highlights**

The QUART dido2000 series diagnostic x-ray dosimeters can be used for QA and service in Radiography, (Pulsed) Fluoroscopy, DSA, Dental, 3D (CBCT), and Mammography.

**Features**

- Compact multi-functional state-of-the-art solid state detector
- Enable measurements in spots with limited space
- Measurements behind scatter radiation grids
- Direct measurement of DWP in dental panoramic applications



## QUART · didoSVM Precision Survey Meter

**Highlights**

- The QUART didoSVM survey meter is designed to detect beta, gamma and x-ray sources of very low intensity around diagnostic x-ray equipment as well as in radiation therapy environments. It features an excellent energy response to measure radiation rate and dose.
- Its detection technology is based on solid-state components, thus enabling measurements with high sensitivity and very quick response.

## QUART · DSA Test Phantom

**Highlights**

- The QUART DSA phantom features longitudinal sliding technique to minimise structural movement artefacts in the test image. It complies with DIN 6868-4, 6868-150 and IEC 61223-3-3.
- A special characteristic of the phantom is that it realistically reproduces the injection procedure of the contrast agent into vessels with different attenuation properties.

## QUART · DVT AP Cone-Beam CT Test Phantom

**Highlights**

- The QUART DVT AP phantom is designed for QA/QC at Cone Beam CT (CBCT), Dental Volume Tomography (DVT) and 3D imaging equipment.
- That includes applications in dental 3D imaging (according to DIN 6868-161 requirements) as well as angiography in C-arm x-ray applications (manufacturer-specific applications). Based on latest research, the solution can also be utilised for standard CT IQ tests.

## QUART · DVT 150 CBCT IQ Test Phantom

**Highlights**

- The QUART DVT 150 phantom is designed to meet the requirements of the German DIN 6868-150 x-ray imaging acceptance test standard. Handling and positioning of the phantom is easy and straight-forward. It enables quick and simple contrast resolution tests for 3D ENT and angiography x-ray applications.

## QUART · mam/digi Mammography IQ Phantom

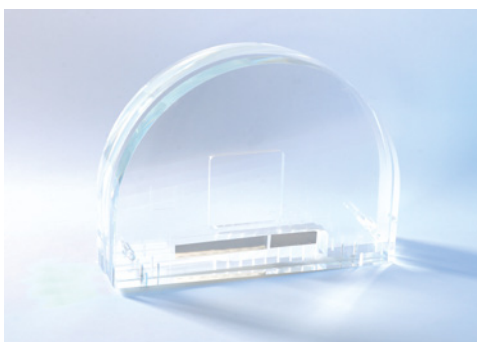
**Highlights**

- The QUART mam/digi phantom is designed to be used as universal tool for QA/QC routine testing in Digital and Analog Mammography. The phantom creates a link between technical and clinical image quality. It can also be used as QA tool for Digital Tomosynthesis.
- The phantom incorporates QUART's unique Landolt ring objects. They are used to verify low-contrast and perceptibility limits.

# RAD BOOK 2015

Please visit us at

[www.healthcare-in-europe.com](http://www.healthcare-in-europe.com)

QUART · nonius Electronic X-Ray Ruler



**Highlights**

- The QUART nonius is a sophisticated, fully electronic x-ray ruler to verify size and geometrical properties of x-ray fields in Radiography and Mammography. It can also be used to analyse fanned CT or dental OPT x-ray beams.
- Its resolution capabilities and precision go down into the nonius range of 0.1 mm!
- Take only 3 steps to obtain the test result: Position – Expose – Evaluate.

QUART · SP dl R/F IQ Phantom



**Highlights**

- The QUART SP dl phantom enables assessment of digital x-ray equipment according to the German DIN 6868-150 and DIN 6868-4.
- The phantom is available with a unique kV test object to assess radiation quality and generator performance on a routinely basis.
- For ease of use, a frame / extension is provided as well as a wire-mount system for use with wall stand units.

Radcal · ACCU-GOLD+



**Highlights**

- Extensive Sensor Selection
- Both Solid State and Gold Standard Ion Chamber Technology
- Rapid Simultaneous Measurements
- The Smallest Footprint Solid State Sensor
- Customizable Software
- Replaces first generation Accu-Gold Diagnostic System
- WiFi available using Nugget device

Radcal · ACCU-DOSE+



**Highlights**

- The newest member of the Accu-Gold family
- Dose Measurement System with WiFi
- Gold Standard Ion Chamber Sensors & Solid-state Dose Diode Sensors
- Excellent Solution for Radiography, Fluoroscopy, Mammography, CT & Dental applications
- Dose-oriented set of functionality including Dose, Dose Rate, Waveform, Pulse, dose / pulse & Exposure time
- Several display options & customizable software

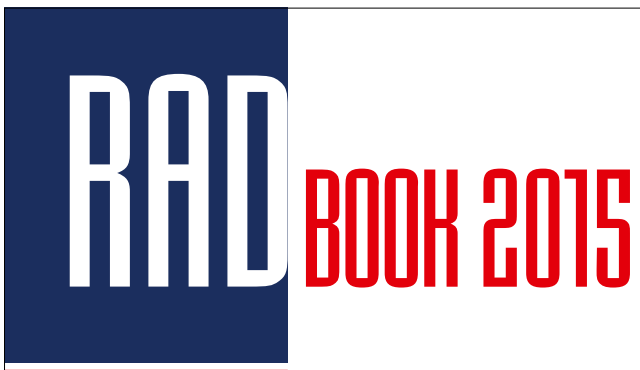

Please visit us at  
[www.healthcare-in-europe.com](http://www.healthcare-in-europe.com)

Radcal · DAP Analyzers



**Highlights**

- PDC (Patient Dose Calibrator)
- Use to calibrate DAP (Dose Area Product) meters
- Measures and displays DAP / Rate, Dose / Rate
- Optical and radiographic alignment markers
- Simple to use with optional computer control

Radcal · RAPID-GOLD+



**Highlights**

- Accu-Gold+ Technology
- Uses only Solid State Sensors for Diagnostic, Dental and Mammography X-Ray
- Optional mA / mAs invasive or Non-invasive measurement sensors
- Replaces first generation Rapid-Gold
- WiFi available using Nugget device

# RAD BOOK 2015

Please visit us at

[www.healthcare-in-europe.com](http://www.healthcare-in-europe.com)

RTI · Black Piranha



**Highlights**

The RTI Black Piranha brings quickness and power to your X-ray QA work. The Black Piranha includes what you would expect in a multifunction meter. Connection to various accessories, tablet and PC. The Quick Check feature identifies the probes you insert and selects the optimum settings for your measurements. One-shot HVL for Mammography, Radiography, CT and Dental. Optimized for X-ray equipment from a large number of manufacturers.

RTI · Cobia Smart



**Highlights**

Cobia Smart is a straightforward and simple-to-use instrument for checking that the output from an X-ray tube is correct. Place it beneath the X-ray tube, make an X-ray exposure, and rapidly get an accurate reading. The measured values can be read directly from Cobia Smart's large and clear display, even from a distance. No adjustments are required, making it exceptionally easy to use. Easy to position, no position dependence.

RTI · Cobia Flex



**Highlights**

Cobia Flex belongs to the straightforward and simple-to-use instruments from RTI. The measured values can be read directly from Cobia Flex's large and clear display or you can choose to use RTI Ocean X-ray QA Software. The Cobia Flex has an internal detector, offers the possibility to, via plug & play, connect different probes, ion chambers and has built-in mAs. Easy to position, no position dependence. Full Auto range (kV, TF and Sensitivity).

RTI · Ocean 2014



**Highlights**

The diagnostic software to use with your RTI instrument. By using Ocean you will speed up your total working process and minimize your time in X-ray room. It displays all your measurements and waveforms gathered on an easy-to-read screen. Ocean suits everybody's needs, it doesn't matter if you require a full report or if you only want to use the computer as a display. Use ocean to collect all your measurements. Press print and you have a complete report in your hand.

Unfors · RaySafe i2



**Highlights**

- Real-time radiation insight
- RaySafe i2 is a dosimetry system that provides real-time insight about personal radiation exposure, as well as access to time stamped dose data
- By providing easily accessible information about radiation exposure, RaySafe i2 allows medical staff to immediately change their behavior in order to minimize their radiation dose

Unfors · RaySafe Solo CT



**Highlights**

- The RaySafe Solo CT is a durable solution for performing dose and DLP measurements on CT machines. It offers precise measurements utilizing an ion chamber with 100 mm active length for calculation of CTDI.
- The RaySafe Solo CT is based on a hybrid detector, which combines ion chamber and electronics in one unit. This enables measurement of temperature and pressure inside the ion chamber.

Unfors · RaySafe Solo DENT



**Highlights**

- The RaySafe Solo DENT with its slim detector is the perfect tool for any radiation beam used in dental X-ray. The meter will handle any type of filtration used in dental applications without a need for corrections.
- It enables measurements of kVp, dose, dose rate, time and pulse measurements on cone beam CT, intra-oral and panoramic X-ray machines.

Unfors · RaySafe Solo DOSE



**Highlights**

- The RaySafe Solo DOSE is the most straight-forward model in the RaySafe Solo assortment and measures dose, dose rate, time and pulses on both Radiographic and Fluoroscopic X-ray machines. It is thus the ideal solution when the need is limited to performing dose measurements only.

Unfors · RaySafe Solo MAM



**Highlights**

- The RaySafe Solo MAM is available in two models: RaySafe Solo MAM and RaySafe Solo MAM dose. They are the ideal solutions for measurements on a large variety of mammography machines.
- Both support the beam qualities Mo/Mo, Mo/Al, Mo/Rh, Rh/Rh, Rh/Al, W/Rh and W/Ag and measure dose, dose rate, time, pulse. Additionally, the RaySafe Solo MAM also includes kV for the beam qualities Mo/Mo and W/Rh.

Unfors · RaySafe ThinX



**Highlights**

- The RaySafe ThinX has been designed to meet the need for a basic multi-parameter
- Instrument for simultaneous measurement of dose, dose rate, kVp, HVL, time and pulses.
- All parameters can be continually viewed in the convenient LCD display. There is no need to adjust settings, set-up or range selection, as the RaySafe ThinX works all automatically.



Unfors · RaySafe X2



**Highlights**

- Less effort. More insight.
- The RaySafe X2 is a complete system offering sensors for R/F, MAM, CT and even light applications. All sensors are made without the need to select ranges or special modes. Sensors and electronics are specifically designed to minimize the need for user interaction. Waveforms of kV and dose rate can be analyzed directly on the base unit.

Unfors · RaySafe Xi

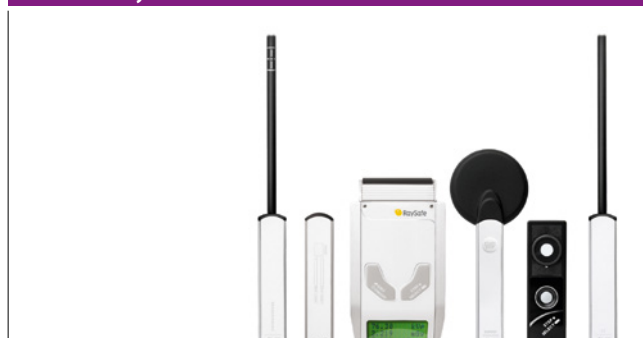

**Highlights**

The RaySafe Xi is a complete system for multiparameter measurements on all X-ray modalities. It simultaneously measures everything from kVp and dose to HVL and waveforms. It is preferred by leading experts from all over the world. Invest just a few seconds of your life in RaySafe Xi, and it may completely change it. At least in the way you measure on X-ray equipment.

VacuTec · VacuDAP / VacuDAP duo



**Highlights**

The VacuDAP family provides a wide range of DAP and Dose measuring solutions for most of the diagnostic X-ray systems in the market.

**Technical specs**

- Resolution DAP: 0,01  $\mu\text{Gym}^2$
- Resolution Dose: 0,003 mGy
- Interface: RS485, RS232, Bluetooth, CAN
- Active area: (123x123) mm / (147x147) mm

VacuTec · VacuDAP-C / VacuDAP-C duo



**Highlights**

The VacuDAP-C systems for measurement of DAP and Dose are basically integrated in interventional devices with customized calibration settings.

**Technical specs**

- Resolution DAP: 0,001  $\mu\text{Gym}^2$
- Resolution Dose: 0,0004 mGy
- Interface: RS485, RS232, Bluetooth, CAN
- Active area:  $\varnothing$  (8 ... 100) mm

VacuTec · VacuDAP wireless / VacuDAP Bluetooth



**Highlights**

- VacuDAP chamber is now available with Wi-Fi or Bluetooth technology.
- Perfect suitable for DR upgrades and mobile X-ray units.
- The battery ensures simplest installation ever.

**Technical Specs**

- Resolution DAP: 0,01  $\mu\text{Gym}^2$
- Active area: (123x123) mm / (147x147) mm
- Battery operation time: about 12 h

VacuTec · VacuTec AEC Sensor

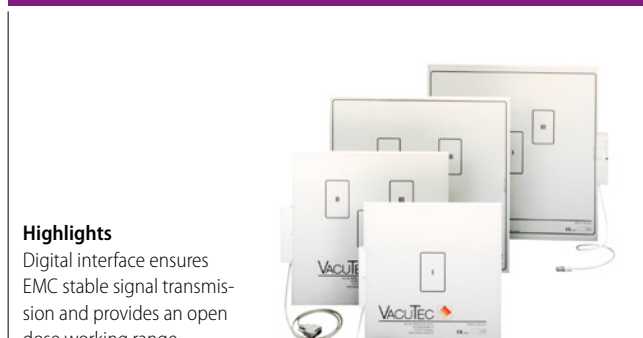

**Highlights**

Digital interface ensures EMC stable signal transmission and provides an open dose working range.

**Technical specs**

- Tube voltage: 40 kV ... 150 kV
- Dose rate range: 0,5 ... 1000  $\mu\text{Gy} / \text{s}$
- Aluminium equivalent: 0,75 mm Al
- Digital interface: differential pulses (RS422)
- Resolution: 0,025  $\mu\text{Gy}$
- Pulse width: 2  $\mu\text{s}$
- Analog interface: ramp voltage 0 ... 10 V

# INDEX OF ADVERTISERS

	page
 <b>AGFA</b> HealthCare	103
 <b>Alliance Medical</b>	17
 <b>CHISON</b> Value Beyond Imaging	151
 <b>DOTmed</b>	189
 <b>DUNLEE</b> A Division of Philips Healthcare	13
 <b>EKSIS</b>	125
 <b>HITACHI</b> Inspire the Next	5
 <b>KONICA MINOLTA</b>	115
 <b>Medicor</b>	83
 <b>MEDTRON</b> AG	41
 <b>Medtronic</b>	back cover
 <b>NEC</b>	145
 <b>DOME</b> by NDSsi	139
 <b>RTI</b>   From Radiation to Information	177
 <b>SAMSUNG</b>	back cover
 <b>SCHILLER</b> The Art of Diagnostics	33
 <b>SHIMADZU</b> Excellence in Science	front cover
 <b>SIEMENS</b>	7
 <b>SIUI</b> See the future	153
 <b>SonoScape</b>	171
 <b>SOREDEX</b>	19, 131
 <b>TERARECON</b>	front & back cover
 <b>VISUS</b>	67
 <b>WDM</b>	27
 <b>Xgy</b>	29

# healthcare-in-europe.com

Trends & innovations in healthcare.



**25 YEARS**  
of European  
healthcare  
communication:  
print & online.



**Stay  
tuned  
on all  
channels.**

Online Portal | Newspaper | Product Guides | Newsletter

published by  
**EUROPEAN HOSPITAL**

European Hospital Verlags GmbH | Theodor-Althoff-Straße 45 | 45133 Essen  
follow us on | visit us on   
[www.healthcare-in-europe.com](http://www.healthcare-in-europe.com)













# COMPANIES & SUPPLIERS

Company	RIS	PACS	Workstations	CT	MRI	Injectors	Interventional	IT Systems	Mammography	R/F Film-Screen	R/F Digital	Molecular Imaging	Displays	Printers	Ultrasound	Testing Devices
<b>Agfa HealthCare</b> Septestraat 27 2640 Mortsel, Belgium tel +32 3 444 94 44 agfahealthcareinfo.be@agfa.com www.agfahealthcare.com	3	3 4	197 198					61 66 74 76			97 101 102 112 118 121			148 149		
<b>Alliance Medical Interim Solutions</b> Icen Centre, Warwick Technology Park, Warwick, CV34 6DA, UK tel +44 192 648 20 00 info@alliancemedical.com www.alliancemedical.com				21	37		59					133				
<b>APOLLORT Co., Ltd</b> Room 32, Apex Business Centre, 25/F Grandion Plaza, 932 Cheung Sha Wan Road, Kowloon, Hong Kong tel +852 29 59 70 11 contact@apollo-rt.com www.apollo-rt.com						39										
<b>Barco N.V.</b> President Kennedypark 35 8500 Kortrijk, Belgium tel +32 56 23 32 11 sales.medical.eu@barco.com www.barco.com													135 138 143 146			
<b>Bayer Medical Care BV</b> Horsterweg 24 6199 AC Maastricht Airport, The Netherlands tel +31 43 358 56 01 www.ri.bayer.com						39 40										
<b>Bracco Injengineering S.A.</b> Avenue de Sévelin 46 1004 Lausanne, Switzerland tel +41 21 621 74 00 info.injengineering@bracco.com www.imaging.bracco.com						40 41										
<b>Canon Europa N.V.</b> Bovenkerkerweg 59 1185 XB Amstelveen, The Netherlands tel +31 20 545 8 545 medical.x-ray@canon-europe.com www.canon-europe.com/medical	3	3 4	197 198					70 76			102 103 112 121					
<b>CHILI GmbH</b> Friedrich-Ebert-Str. 2 69221 Dossenheim / Heidelberg, Germany tel +49 62 21 180 79 10 sales@chili-radiology.com www.chili-radiology.com		3 4	197 198					61 62 70 74					150			
<b>CHISON Medical Imaging Co., Ltd.</b> No. 9 Xin Hui Huan Road, New District, Wuxi, Jiang Su Province, China 214028 tel +086 510 85 31 05 93 export@chison.com.cn www.chison.com															154 155	
<b>DMS APELEM</b> 393 rue Charles Lindbergh 34130 Maugeio, France tel +33 4 67 50 49 00 www.dms.com							53		78	88 91	103 104 112 122 126 127					
<b>Dome by NDSsi</b> Nijverheidscentrum 28 2761 JP Zevenhuizen, The Netherlands tel +31 180 63 43 56 info-emea@ndssi.com www.ndssi.com													135 140 141 144 147	150		
<b>Dunlee Medical Components</b> European Customer Service Center Veenpluis 6 5684 PC Best, The Netherlands tel +31 40 276 25 00 dunlee.emea-japan@philips.com www.dunlee.com					21 22						127					

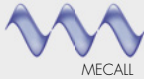

	RIS	PACS	Workstations	CT	MRI	Injectors	Interventional	IT Systems	Mammography	R/F Film-Screen	R/F Digital	Molecular Imaging	Displays	Printers	Ultrasound	Testing Devices
<b>EBIT S.r.l. – Esaote Group</b> Via Siffredi 58 16153 Genoa, Italy tel +39 010 65 47-464 info@ebit.it www.esaote.com/healthcare-it		3	3	197				62 66 67 68 72								
<b>EIZO Europe GmbH</b> Helmut-Grashoff-Str. 18 41179 Moenchengladbach, Germany tel +49 21 61 82 10-120 info@eizo.de www.eizo.de													135 138 140 143 144 146 147 148			
<b>Esaote S.p.A.</b> Via Siffredi 58 16153 Genoa, Italy tel +39 010 65 47-1 info@esaote.com www.esaote.com					32 33		59								155 156	
<b>FUJIFILM EUROPE GMBH</b> Heesenstr. 31 40549 Duesseldorf, Germany tel +49 211 50 89-0 medical@fujifilm.eu www.fujifilm.de/medical		3	3	197				62 63 68 70 72 74 76	78 79		97 100 104 105 113 114 118			149		
<b>GCTechnology GmbH</b> Freidling 12 84172 Buch am Erlbach, Germany tel +49 87 06 94 15 00 info@gctech-gmbh.com www.gctech-gmbh.com					22	37	59		84	94						172
<b>GE Healthcare</b> 283 Rue de la Minière 78533 Buc Cedex, France tel +33 130 70 40 40 response@med.ge.com www.gehealthcare.com		3	3	197	9 16 17 18 19	26 28 30	48 49 50 53 54	63 74	79	91	105 114 118	130 131 132			156 157	
<b>GENERAL MEDICAL MERATE S.p.A.</b> Via Partigiani, 25 24068 Seriate (BG), Italy tel +39 035 45 25 311 info@gmmspa.com www.gmmspa.com							54 57			87 88	105 106 122					
<b>Giotto / IMS Internazionale Medico Sci</b> Sagittario, 5 40037 Sasso Marconi (BO), Italy tel +39 051 84 68 51 imscomm@imsitaly.com www.imsitaly.com									78 80 83							
<b>Hitachi Medical Systems Europe (Holding) AG</b> Sumpfstrasse 13 6300 Zug, Switzerland tel +41 41 748 63 33 welcome@hitachi-medical-systems.com www.hitachi-medical-systems.com					9 18	31 33 34					127				158 159	
<b>Hologic Europe N.V.</b> Leuvensesteenweg 250A 1800 Vilvoorde, Belgium tel +32 2 711 46 80 hologic.europe@hologic.com www.hologic.com						36	57	73	79 82 83 84 85		127 128					
<b>I.A.E. S.P.A.</b> Via Fabio Filzi, 53 20032 Cormano (MI), Italy tel +39 02 66 30 32 55 iaexray@iae.it www.iae.it					22		59		85		128					
<b>IBA Dosimetry GmbH</b> Bahnhofstr. 5 90592 Schwarzenbruck, Germany tel +49 91 28 607-14 dosimetry-info@iba-group.com www.iba-dosimetry.com																174 175 176

# COMPANIES & SUPPLIERS

Company Name	Address	Logo	RIS	PACS	Workstations	CT	MRI	Injectors	Interventional	IT Systems	Mammography	R/F Film-Screen	R/F Digital	Molecular Imaging	Displays	Printers	Ultrasound	Testing Devices
<b>IMAGE Information Systems Europe GmbH</b> Lange Str. 16 18055 Rostock, Germany tel +49 381 496 58 20 info@image-systems.biz www.image-systems.biz			3	3 4	197 198					63 68 73 74 75								
<b>IMS Internazionale Medico Sci</b> Sagittario, 5 40037 Sasso Marconi (BO), Italy tel +39 051 84 68 51 imscomm@imsitaly.com www.imsitaly.com											78 80 83							
<b>INTERMEDICAL SRL</b> E. Fermi, 26 24050 Grassobbio (BG), Italy tel +39 035 659 48 11 info@inter-med.it www.inter-med.it									50 54 57									
<b>i-SOLUTIONS Health GmbH</b> Am Exerzierplatz 14 68167 Mannheim, Germany tel +49 621 39 28-0 info@i-solutions.de www.i-solutions.de			3	3 4						64 76								
<b>ITZ Medicom GmbH &amp; Co. KG</b> Siemensring 44a 47877 Willich, Germany tel +49 21 54 49 79 60 info@itz-medi.com www.itz-medi.com			3	3 4	197 198					64 69 75								
<b>KONICA MINOLTA Medical &amp; Graphic Imaging Europe B.V.</b> Frankfurtstraat 40 1175 RH Lijnden, The Netherlands tel +31 20 659 02 60 info-nl@mg.konicaminolta.eu www.konicaminolta.eu/healthcare				3 4	197 198								101 106 116 119 128			160		
<b>MECALL S.R.L.</b> Via Negrelli, 55 20851 Lissone (MB), Italy tel +39 039 24 31 51 info@meccall.it www.meccall.it													106 122					
<b>medICAD – hectec GmbH</b> Ottostr. 16 84030 Landshut, Germany tel +49 871 33 02 03-0 info@hectec.eu www.hectec.eu					197 198	22	37			71 72								
<b>MMS Medicor Medical Supplies GmbH</b> Heinrich-Hertz-Str. 6 50170 Kerpen, Germany tel +49 22 73 98 08-0 zentrale@medicor.de www.mms-medicor.de								42					133					
<b>medifa-hesse GmbH &amp; Co. KG</b> Industriestr. 5 57413 Finnentrop, Germany tel +49 27 21 71 77-0 info@medifa.com www.medifa.com									54									
<b>medigration GmbH</b> Schuhstr. 30 91052 Erlangen, Germany tel +49 91 31 690 87-40 info@medigration.de www.medigration.de			3	3 4	197 198					64 69 70 71 72 73 75		106 116				149 150		
<b>MEDTRON AG</b> Hauptstr. 255 66128 Saarbruecken, Germany tel +49 681 970 17-0 info@medtron.com www.medtron.com								42 43										





Think **DOTmed**<sup>®</sup>

## **Buying or selling used equipment?**

Think DOTmed – where more than 20,000 daily visitors shop more than 400,000 items for sale.

And find parts and service, too!

**[www.dotmed.com](http://www.dotmed.com)**

The world's leading medical equipment marketplace

# COMPANIES & SUPPLIERS

	RIS	PACS	Workstations	CT	MRI	Injectors	Interventional	IT Systems	Mammography	R/F Film-Screen	R/F Digital	Molecular Imaging	Displays	Printers	Ultrasound	Testing Devices
<b>Medtronic International Trading Sàrl</b> Route du Molliou 31 1131 Tolochenaz, Switzerland tel +41 21 802 70 00 info@medtronicnavigation.com www.medtronicnavigation.com					35		51									
<b>SHENZHEN MINDRAY</b> BIO-MEDICAL ELECTRONICS CO., LTD. Mindray Building, Keji 12th Road South Nanshan, Shenzhen 518057, China tel +86 755 81 88 89 98 intl-market@mindray.com www.mindray.com					34										160	161
<b>NEC Display Solutions Europe GmbH</b> Landshuter Allee 12 – 14 80637 Munich, Germany tel +49 89 99 96 99-0 med-support@nec-displays.com www.medical.nec-display-solutions.com													135 141 142 144 147			
<b>Dome by NDSsi</b> Nijverheidscentrum 28 2761 JP Zevenhuizen, The Netherlands tel +31 180 63 43 56 info-emea@ndssi.com www.ndssi.com								80					135 140 141 144 147	150		
<b>NORAS MRI products GmbH</b> Leibnizstr. 4 97204 Hoechberg, Germany tel +49 931 29 92 70 info@noras.de www.noras.de					36											
<b>Planmed Oy</b> Sorvaajankatu 7 00880 Helsinki, Finland tel +358 20 77 95 300 sales@planmed.com www.planmed.com				20				80 81 82								
<b>Primax International</b> "Le Minotaure" 30 – 34 Avenue Henri Matisse 06200 Nice, France tel +33 492 29 23 30 sales@primaxint.com www.primaxint.com							58				107 119 122					
<b>PROTEC GmbH &amp; Co. KG</b> In den Dorfwiesen 14 71720 Oberstenfeld, Germany tel +49 70 62 925 50 protec@protec-med.com www.protec-med.com		4	197 198					64		87 94	107 116 117					
<b>PTW-Freiburg</b> Physikalisch-Technische Werkstätten Dr. Pychlau GmbH Loerracher Str. 7 79115 Freiburg, Germany tel +49 761 490 55-0 info@ptw.de www.ptw.de															177 178	
<b>QUART GmbH</b> Kirchenweg 7 85604 Zorneding, Germany tel +49 81 06 24 91 18 info@quart.biz www.quart.de									85	94					178 179 180	
<b>Radcal Corporation</b> 426 West Duarte Road Monrovia, CA 91016, USA tel +1 626 357 7921 sales@radcal.com www.radcal.com															180 181	
<b>RTI Electronics</b> Floejelbergsgatan 8C 43137 Moelndal, Sweden tel +46 31 746 36 00 sales@rti.se www.rti.se																181



Company Name	RIS	PACS	Workstations	CT	MRI	Injectors	Interventional	IT Systems	Mammography	R/F Film-Screen	R/F Digital	Molecular Imaging	Displays	Printers	Ultrasound	Testing Devices
<b>SAMSUNG MEDISON CO., LTD.</b> 42, Teheran-ro 108-gil, Gangnam-gu, Seoul, Korea tel +82 2 21 94 14 00 sales@samsungmedison.com www.samsungmedison.com															162 163	
<b>SCHILLER AG</b> Altgasse 68, P.O. Box 10 52 6341 Baar, Switzerland tel +41 41 766 42 42 sales@schiller.ch www.schiller.ch					37											
<b>Sectra AB</b> Teknikringen 20 58330 Linköping, Sweden tel +46 13 23 52 00 info.medical@sectra.com www.sectra.se/medical	3	3 4	197 198					66 73 75 76		94			148			
<b>Shimadzu Europa GmbH</b> Medical Systems Division Albert-Hahn-Str. 6 – 10 47269 Duisburg, Germany tel +49 203 76 87-0 medical@shimadzu.eu www.shimadzu.eu							48 51 55			87 89 91 92	108 119 123					
<b>Siemens AG, Healthcare Sector</b> Henkestr. 127 91052 Erlangen, Germany tel +49 91 31 84-0 contact.healthcare@siemens.com www.siemens.com/healthcare		3 4	197 198	9 12 16 18 19 20	26 28 31 34 35		48 51 52 55 56 58	66 69 71 73	80 81 82	88 89 92 93	108 119 123	130 132 133			164 165	
<b>Shantou Institute of Ultrasonic Instr. Co., Ltd.</b> #77, Jinsha Road 515041 Shantou, China tel +86 754 88 25 01 50 siui@siui.com www.siui.com															165 166 167 168	
<b>Sonoscape Medical Corp.</b> 9/F, Yizhe Building, Yuquan Rd. 518051 Shenzhen, China tel +86 755 26 72 28 90 sonoscape@sonoscape.net www.sonoscape.com															168 169 170	
<b>Soredex</b> Nahkelantie 160 04300 Tuusula, Finland tel +358 10 270 20 00 info@soredex.com www.soredex.com				20												
<b>STEPHANIX</b> 10, Rue Jean Moulin 42150 La Ricamarie, France tel +33 4 77 47 81 60 contact@stephanix.com www.stephanix.com							56			88 89 93	109 119 120 124					
<b>SuperSonic Imagine</b> Les Jardins de la Duranne, Bât E & F 510, Rue René Descartes 13857 Aix-en-Provence, France tel +33 442 99 24 32 contactsFR@supersonicimagine.fr www.supersonicimagine.fr															170	
<b>Swissray Medical AG</b> Turbistr. 25 – 27 6280 Hochdorf, Switzerland tel +41 41 914 12 12 sales@swissray.com www.swissray.com											109 110 120					
<b>Technix S.p.A.</b> Via Fermi 45 24050 Grassobbio (BG), Italy tel +39 035 384 66 11 technixd@technix.it www.technix.it							56				120 121					

# COMPANIES & SUPPLIERS

Company	RIS	PACS	Workstations	CT	MRI	Injectors	Interventional	IT Systems	Mammography	R/F Film-Screen	R/F Digital	Molecular Imaging	Displays	Printers	Ultrasound	Testing Devices
<b>TeraRecon</b> Walther-von-Cronberg-Platz 16 60594 Frankfurt, Germany tel +49 69 951 03 52-0 info@terarecon.com www.terarecon.com		4	197 198					69 71 75								
<b>Toshiba Medical Systems Europe</b> Zilverstraat 1 2718 RP Zoetermeer, The Netherlands tel +31 79 368 92 22 info@tme.nl www.toshiba-medical.eu				12 16 17 20	28 32		48 49 52 53			88 89 90	110 120 124					171 172
<b>Toshiba Electronics Europe GmbH</b> Hansaallee 181 40549 Duesseldorf, Germany tel +49 211 52 96-0 info@toshiba-components.com www.toshiba-components.com				21			59				110 117 128					
<b>TOTOKU Europe GmbH</b> Jakob-Krebs-Str. 124 47877 Willich, Germany tel +49 21 56 49 68 80 info@totoku.de www.totoku.de													138 142 143 144 146			
<b>Ulrich GmbH &amp; Co. KG</b> Buchbrunnenweg 12 89081 Ulm, Germany tel +49 731 96 54-0 info@ulrichmedical.com www.ulrichmedical.com						43 44										
<b>Unfors RaySafe AB</b> Uggledalsvaegen 29 42740 Billdal, Sweden tel +46 31 719 97 00 info.se@raysafe.com www.raysafe.com																182 183
<b>VacuTec Meßtechnik GmbH</b> Dornbluethstr. 14 01277 Dresden, Germany tel +49 351 317 24-0 info@vacutec-gmbh.de www.vacutec-gmbh.de																183
<b>Varian Medical Systems GmbH</b> Karl-Arnold-Str. 12 47877 Willich, Germany +49 21 54 92 49 80 info.xray@varian.com www.varian.com/xray				22					85		117					
<b>VILLA SISTEMI MEDICALI s.p.a.</b> Via delle Azalee, 3 20090 Buccinasco (MI), Italy tel +39 02 48 85 91 sales@villasm.com www.villasm.com				20			56		81 82	88 90 93	111 118 121 124 126					
<b>VISUS Technology Transfer GmbH</b> Universitaetsstr. 136 44799 Bochum, Germany tel +49 234 936 93-0 sales@visus.com www.visus.com		3 4	197 198					66 69 73 75								
<b>Vital Images Europe B.V.</b> Zilverstraat 1 2718 RP Zoetermeer, The Netherlands tel +31 79 206 58 00 info@vitalimages.com www.vitalimages.com		4	197 198					69 70 71								
<b>China Resources Wandong Medical Equipment Co., Ltd.</b> Bld.3, No. 9 Jiuxianqiaodong Road Chaoyang District 100015 Beijing, China tel +86 10 845 757 92 international@wandong.com.cn www.wandong.com.cn					32 34		53 57		81	91 93	111 112 121 126					

Company	RIS	PACS	Workstations	CT	MRI	Injectors	Interventional	IT Systems	Mammography	R/F Film-Screen	R/F Digital	Molecular Imaging	Displays	Printers	Ultrasound	Testing Devices
<b>Ningbo Xingyao Medical Instruments Co. Ltd</b> (XGY Medical) 777 West Tanjialing Rd. 315400 Yuyao, China tel +86 574 627 308 99 sales@china-mri.com www.china-mri.com					32 35						126					
<b>Zihtm Imaging GmbH</b> Donaust. 31 90451 Nuremberg, Germany tel +49 911 21 72-0 info@ziehm-eu.com www.zihtm-eu.com							57 58									

NOTES











**Experience  
S-Vision architecture  
and S-Vue transducer**

Consisting of the newly developed S-Vision architecture and S-Vue transducer, RS80A offers the cutting-edge technologies for outstanding images.



**EXPERIENCE A TRULY PREMIER  
ULTRASOUND SYSTEM**

RS80A, a radiology ultrasound, increases diagnostic confidence utilizing advanced technologies developed by Samsung, while simultaneously enhancing user experience and providing an efficient work environment.

**SAMSUNG ULTRASOUND RS80A**



Scan code or visit  
[www.samsungmedison.com](http://www.samsungmedison.com)  
to learn more



## Workstations

	Multimodality	Mammography	Orthopedics	Cardiology	CAD
	Impax Clinical Applications	Impax Mammography	Impax Clinical Applications	Impax Clinical Applications	
	Canon PACS	Canon PACS			CAD for Tuberculosis
	CHILI Diagnost	CHILI Diagnost	CHILI Diagnost	CHILI Diagnost	Partner-Solution
	Suitestensa Review	Suitestensa MG	Suitestensa Review	Suitestensa Review Cardio	
	SYNAPSE PACS	AXON Mammo SYNAPSE PACS		SYNAPSE CARDIOVASCULAR	Digital Mammography CAD
	Centricity PACS Universal Viewer Universal Viewer Zero Footprint XDS enabled	Centricity PACS Universal Viewer web client provides Breast Imaging tools powered by IDI	Centricity PACS Universal Viewer with integrated Traumacad by Voyant Health	Centricity Cardio Enterprise	Centricity PACS Universal Viewer web client embeds advanced visualization powered by AW
	iQ-VIEW PRO	iQ-VIEW PRO MAMMO TOMO	iQ-VIEW PRO OrthoView	iQ-VIEW PRO 4D	
					
	ITZ Hyper.PACS	ITZ Hyper.PACS	ITZ Hyper.PACS Hectec RSA-Biomedical Localite	Hyper.PACS PIE-Medical Tomtec	ITZ Hyper.PACS Intrasense Terarecon Median
	Acies ImagePilot	Acies	Acies		Acies
			mediCAD Classic mediCAD mobile mediCAD Practice GO mediCAD veterinary		mediCAD Classic mediCAD mobile mediCAD Practice GO mediCAD veterinary
	ImageVision Diagnost	MammoView	ImageVision Basic	ImageVision Diagnost	MammoView CAD
	PROPAXX and / or CONAXX 2		PROPAXX and / or CONAXX 2		
	Sectra IDS7 / dx / mx / mqa / qa/cx Anatomical Linking	Sectra IDS7 / mx / mqa	Sectra Preop Online Sectra IDS7 Sectra Orthostation Package	Sectra IDS7 / dx Sectra Clinical Solution Network	Sectra IDS7 / mx
	syngo.via syngo.plaza	syngo.via syngo.plaza	MediCAD (HECTEC) syngo.via syngo.plaza	syngo Dynamics syngo.via	syngo CAD Applications syngo.via syngo.plaza
	iNtuition, iNteract+			iNtuition	iNtuition with Aquarius APS
	JiveX Diagnostic	JiveX Diagnostic Mammo JiveX Diagnostic Tomosynthesis	JiveX Diagnostic	JiveX Diagnostic	Partner Solution
	VitreAdvanced			VitreAdvanced	VitreAdvanced



## Workstations

Advanced Visualization	
Impax Clinical Applications	<b>Agfa HealthCare</b> Septestraat 27 · 2640 Mortsel, Belgium tel +32 3 444 94 44 agfahealthcareinfo.be@agfa.com · www.agfa.com
Canon PACS	<b>Canon Europa NV</b> Bovenkerkerweg 59 · 1185 XB Amstelveen, The Netherlands tel +31 20 545 8 545 medical.imaging.IT@canon-europe.com · www.canon-europe.com/medical
Partner-Solution	<b>CHILI GmbH</b> Friedrich-Ebert-Str. 2 · 69221 Dossenheim/Heidelberg, Germany tel +49 6221 1 80 79 10 info@chili-radiology.com · www.chili-radiology.com
Suitestensa 3D Suitestensa Vascular	<b>EBIT S.r.l. – Esaote Group</b> Via Siffredi 58 · 16153 Genoa, Italy tel +39 010 65 47-464 info@ebit.it · www.esaote.com/healthcare-it
SYNAPSE 3D SYNAPSE MOBILITY	<b>FUJIFILM EUROPE GMBH</b> Heesenstr. 31 · 40549 Duesseldorf, Germany tel +49 211 5089-246 medical@fujifilm.eu · www.fujifilm.de/medical
Centricity PACS Universal Viewer web client embeds advanced visualization powered by AW	<b>GE Healthcare</b> Lerchenbergstr. 15 · 89160 Dornstadt, Germany tel +49 7348 9861-0 response@med.ge.com · www.gehealthcare.com
iQ-VIEW PRO 4D	<b>IMAGE Information Systems Europe GmbH</b> Lange Str. 16 · 18055 Rostock, Germany tel +49 381 496 58 20 info@image-systems.biz · www.image-systems.biz
	<b>i-SOLUTIONS Health GmbH</b> Am Exerzierplatz 14 · 68167 Mannheim, Germany tel +49 621 39 28-0 info@i-solutions.de · www.i-solutions.de
ITZ Hyper.PACS Intrasense TeraRecon Median	<b>ITZ Medicom GmbH &amp; Co. KG</b> Siemensring 44 a · 47877 Willich, Germany tel +49 2154 497960 info@itz-medi.com · www.itz-medi.com
Acies	<b>Konica Minolta Medical &amp; Graphic Imaging Europe B.V.</b> Frankfurtstraat 40 · 1175 RH Lijnden, The Netherlands tel +31 20 659 02 60 info-nl@mg.konicaminolta.eu · www.konicaminolta.eu/healthcare
	<b>medicAD – hectec GmbH</b> Ottostr. 16 · 84030 Landshut, Germany tel +49 871 33 02 03-0 info@hectec.eu · www.hectec.eu
ImageVision Diagnost	<b>medigration GmbH</b> Schuhstr. 30 · 91052 Erlangen, Germany tel +49 9131 69087-40 info@medigration.de · www.medigration.de
PROPAXX and / or CONAXX 2	<b>PROTEC GmbH &amp; Co. KG</b> In den Dorfwiesen 14 · 71720 Oberstenfeld, Germany tel +49 7062 92550 protec@protec-med.com · www.protec-med.com
Sectra IDS7 / dx Volume Visualization: server- based platform, advanced segmentation, vessel analysis	<b>Sectra AB</b> Teknikringen 20 · 58330 Linköping, Sweden tel +46 13 235 200 info.medical@sectra.com · www.sectra.se/medical
syngo.via	<b>Siemens AG, Healthcare Sector</b> Henkestr. 127 · 91052 Erlangen, Germany tel +49 9131 84-0 contact.healthcare@siemens.com · www.siemens.com/healthcare
iNtuition, iNteract+	<b>TeraRecon</b> Walther-von-Cronberg-Platz 16, 60594 Frankfurt, Germany tel +49 69 9510 352 0 info@terarecon.com · www.terarecon.com
JiveX Diagnostic Advance JiveX Vessel Analysis	<b>VISUS</b> Universitaetsstr. 136 · 44799 Bochum, Germany tel +49 234 93693-0 sales@visus.com · www.visus.com
VitreAdvanced	<b>Vital Images Europe B.V.</b> Zilverstraat 1, 2718 RP Zoetermeer, The Netherlands tel +31 79 206 58 00 info@vitalimages.com · www.vitalimages.com



# TERARECON

## Deconstructed PACS

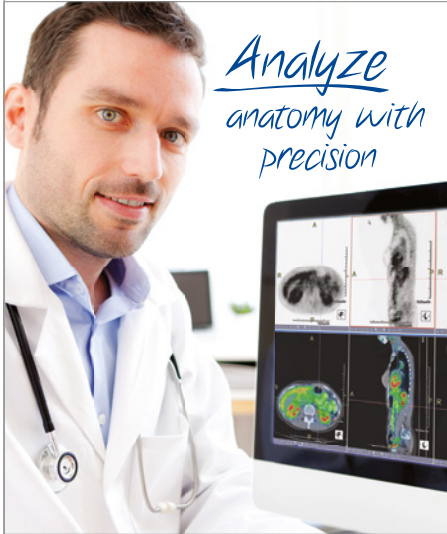

*Analyze  
anatomy with  
precision*

Providing a highly refined and powerful Deconstructed PACS viewer, fully-capable of connecting to existing workflow components



**iNtuition™**  
terarecon.com



Upgrade your intraoperative views.  
Enhance patient outcomes.

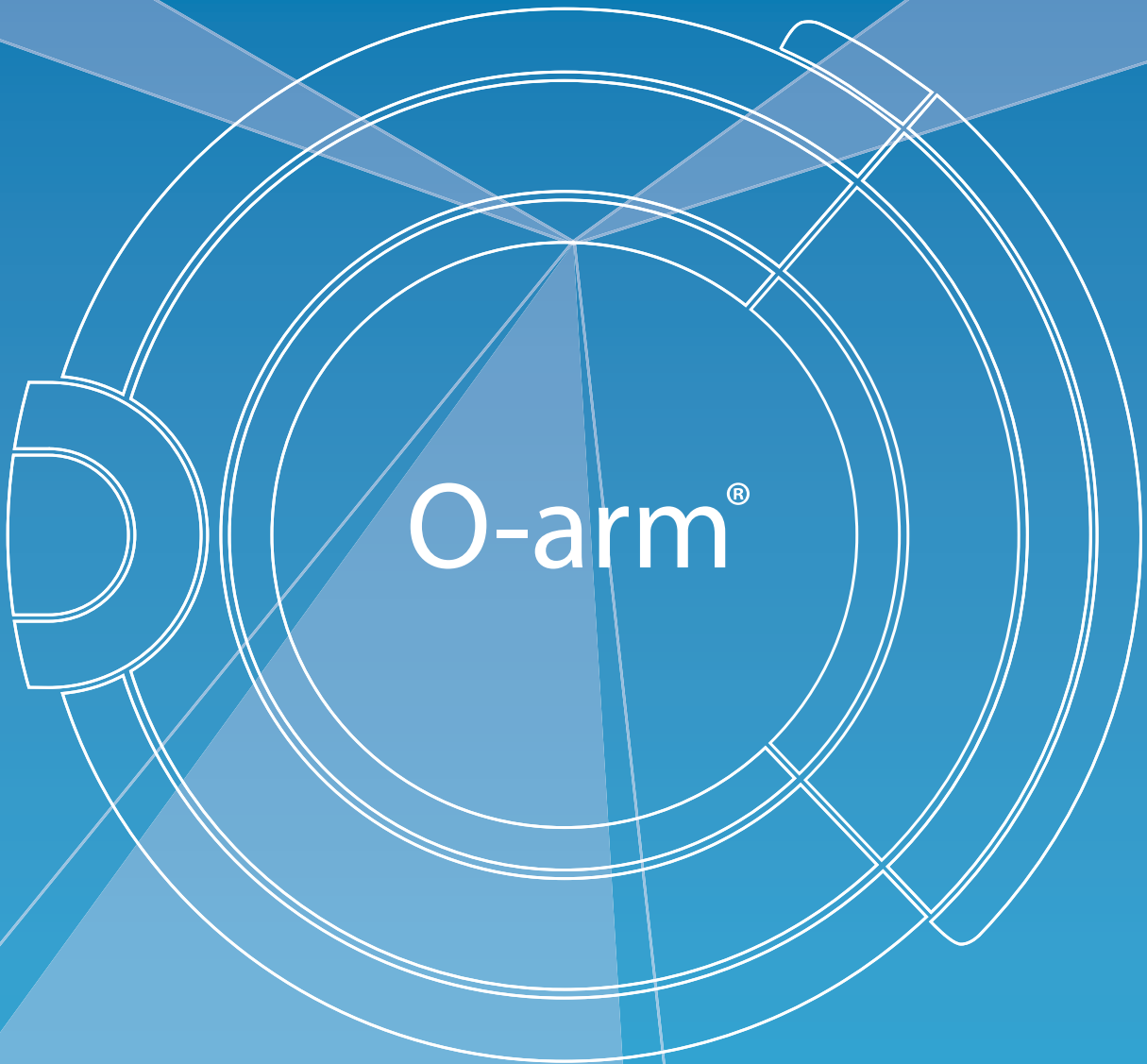

See more in the Interventional Systems chapter!

Surgical **Synergy**<sup>™</sup>  
THE POWER OF INTEGRATION

Innovating for life.