

€ 19.-



The Guide to Imaging  
Technology and Informatics in Europe

# RAD BOOK 2022

Vol. 16



Canon Medical offers a full range of medical imaging solutions including CT, MRI, Ultrasound, Diagnostic and Interventional X-Ray equipment, Mobile Imaging Solutions, and a full suite of Healthcare IT solutions. Discover all our multi-modality solutions in this RADBook edition.

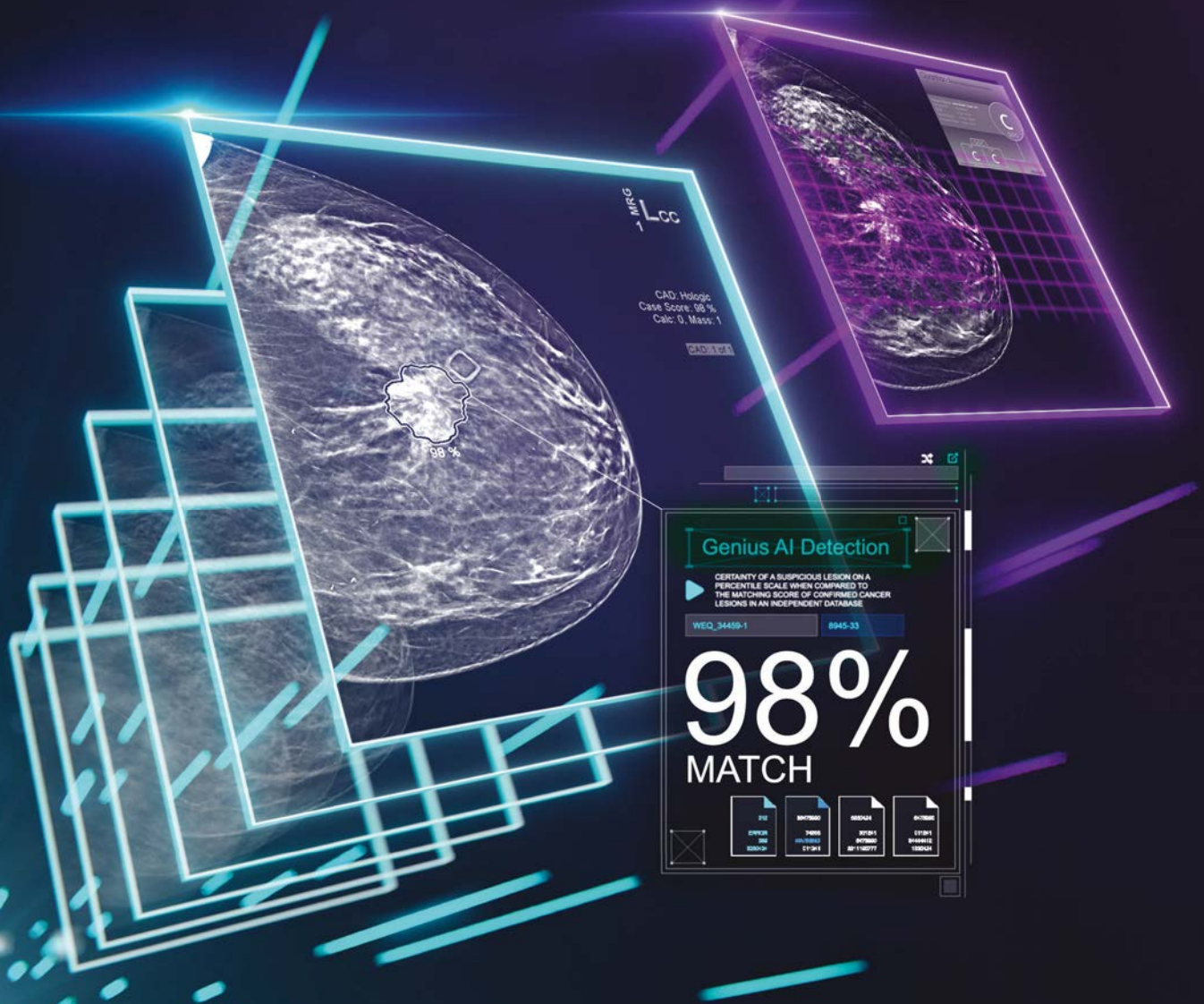

## Discover the integrated AI software solutions designed to help accelerate workflow and improve early detection and diagnosis of breast cancer.

Future-proofed and incorporated in the 3Dimensions™ mammography system enabling confident clinical decision making, providing better patient care.<sup>1-7</sup>

**3D Quorum™**  
IMAGING TECHNOLOGY

**genius AI™**  
DETECTION

**Quantra™**  
BREAST DENSITY ASSESSMENT

[www.3dimensionsmammography.eu](http://www.3dimensionsmammography.eu)

CE 2797 **EC REP** Hologic BV, Da Vincilaan 5, 1930 Zaventem, Belgium.

\*Not CE marked. Not available for sale. Not for distribution. CE Mark expected in April.

**References:** 1. Data On File: DHM-06039 Rev 002 Bartoshevich J, Orefice T, Mansoor S, et al Internal Study comparing Hologic's flat paddle to the SmartCurve paddle (18x24cm) (2017). 2. Friedewald, S.M., Rafferty, E.A., Rose, S.L., et al. Breast cancer screening using tomosynthesis in combination with digital mammography. JAMA. 2014 Jun 25;311(24):2499-507. 3. Zuckerman, S.P., Conant, E.F., Keller, B.M., et al. Implementation of Synthesized Two dimensional Mammography in a Population based Digital Breast Tomosynthesis Screening Program. Radiology. 2016 Dec;281(3):730- 736. 4. Skaane, P., Bandos, A., Eben, EB, et al. Two-view digital breast tomosynthesis screening with synthetically reconstructed projection images: comparison with digital breast tomosynthesis with full-field digital mammographic images. Radiology. 2014 Jun;271(3):655-63. 5. Bernardi, D., Macaskill, P., Pellegrini, M., et al. Breast cancer screening with tomosynthesis (3D mammography) with acquired or synthetic 2D mammography compared with 2D mammography alone (STORM-2): a population-based prospective study. Lancet Oncol. 2016 Aug;17(8):1105-13. 6. McDonald, E.S., Oustimov, A., Weinstein, S.P., et al. Effectiveness of Digital Breast Tomosynthesis Compared With Digital Mammography: Outcomes Analysis From 3 Years of Breast Cancer Screening. JAMA Oncol. 2016 Jun 1;2(6):737-43. 7. Rafferty, E.A., Durand, M.A., Conant, E.F., et al. Breast Cancer Screening Using Tomosynthesis and Digital Mammography in Dense and Nondense Breasts. JAMA. 2016 Apr 26;315(16):1784-6

ADS-03545-EUR-EN Rev 001. Hologic Inc. 2022. All rights reserved. Hologic, 3Dimensions, 3DQuorum, Genius AI Detection, Quantra and associated logos are trademarks and/or registered trademarks of Hologic, Inc., and/or its subsidiaries in the United States and/or other countries. This information is intended for medical professionals and is not intended as a product solicitation or promotion where such activities are prohibited. Because Hologic materials are distributed through websites, eBroadcasts and tradeshows, it is not always possible to control where such materials appear. For specific information on what products are available for sale in a particular country, please contact your local Hologic representative or write to [euinfo@hologic.com](mailto:euinfo@hologic.com)



## Ladies and Gentlemen,

we proudly present: the RADBook 2022 – Your guide to imaging technologies in Europe.

Our comprehensive compilation of more than 600 diagnostic imaging products shows once again the bandwidth of innovative solutions companies provide to make radiologists' work easier every day.

The third year of the Corona pandemic shows that the trend towards digitalisation of processes and the more flexible and mobile use of devices continues – and optimising workflow remains a major task. Numerous products that provide solutions for these tasks are on the market.

Also, an increasing number of experts identify artificial intelligence and edge computing as the next steps in the further development of the medical imaging business. According to Signify Research the world market for medical imaging AI applications is projected to reach almost \$1.2 billion by 2025 with a CAGR of 26%. Certainly, we will continue to keep an eye on this development.

Speaking of development and innovation: The former editors of the RADBook have handed over the sceptre to trusting hands. Our special thanks go to Daniela Zimmermann who after more than 30 years of working for European Hospital decided to retire – at least partly – and handed over all the publications and the website to Mediengruppe Oberfranken Fachverlage (MGO).

Guido Gebhardt remains on our side as a valued consultant.

Enjoy reading!

A handwritten signature in black ink, appearing to read 'M. Scholze'.

**Mareike Scholze**  
Publishing Director

A handwritten signature in black ink, appearing to read 'Bernd Müller'.

**Bernd Müller**  
Managing Director



**Editorial** ..... 3

**Trends & Topics**

First installations of Dunlee's liquid metal bearing CT replacement tubes in the US ..... 8

Canon Medical: Mobile Imaging Solutions: Clinical Confidence Anywhere ..... 10

Febromed: Get up – The swivelling handle system for radiology ..... 14

Siemens Healthineers: First CT scanner with photon-counting technology ..... 20

Medigration: Intelligent IT – Online appointment scheduling for optimum equipment utilization in real-time ..... 55

Hologic: Improving Workflow and Patient Care Through Innovation ..... 70

Hologic: Accurate real-time imaging leads to better breast biopsy patient experience .. 74

Fujifilm: "One-stop" solution partner for the healthcare systems ..... 82

Shimadzu: Cutting-edge product and clinical applications ..... 106

**Companies & Suppliers** ..... 145

Imprint ..... 150

## Products & Solutions

### Computed Tomography

**6**

Photon-counting CT ..... 7

Dual Source CT ..... 7

Volume CT ..... 7

20 to 64 Slices ..... 12

2 to 16 Slices ..... 15

Mobile CT ..... 15

Mammo CT ..... 16

Cone Beam CT ..... 16

Oncology CT ..... 17

Mobile CT Solutions ..... 18

Accessories / Complementary Systems ..... 19

### Magnetic Resonance Imaging

**23**

PET MRI ..... 24

7 Tesla ..... 24

3 Tesla ..... 24

1.5 Tesla ..... 25

High-V MRI (0.55 Tesla) ..... 27

Oncology ..... 27

Open ..... 27

MRI Coils ..... 28

Accessories / Complementary Systems ..... 30



### Injectors

**31**

Accessories / Complementary Systems ..... 34

### Interventional Systems

**36**

Multi-Modality Suites ..... 37

Bi-Plane ..... 37

Single Plane ..... 38

Surgical Flat Panel C-Arms ..... 42

Surgical II-C-Arms ..... 45

Accessories / Complementary Systems ..... 47

### Artificial Intelligence

**52**



### IT Systems

**52**

RIS ..... 53

Business Intelligence ..... 53

PACS ..... 56

VNA ..... 58

Remote Scanning ..... 58

Pathology ..... 59

Reading ..... 59

Portal Solutions ..... 60

Utilities / Add-ons ..... 62

Mobile RIS / PACS Viewers ..... 62

Dose Management Systems ..... 63

Accessories / Complementary Systems ..... 65

<b>Women's Health</b>	<b>66</b>
Mammo CT .....	67
Tomosynthesis .....	67
Digital Mammography .....	68
Biopsy Units .....	69
Film-Screen Mammography .....	73
Mammo Workstations .....	73
Artificial Intelligence .....	76
Accessories / Complementary Systems .....	77

<b>R/F Systems</b>	<b>78</b>
DR .....	80
Bucky .....	92
DR Detectors .....	94
CR .....	100
Flatpanel Fluoro .....	101
Fluoroscopy .....	107
Mobile DR .....	107
Portable DR .....	113
Mobile X-ray .....	114
DXA .....	116
Accessories .....	116

<b>Molecular Imaging</b>	<b>119</b>
PET / CT .....	120
PET / MRI .....	120
SPECT / CT .....	121
SPECT .....	121

<b>Displays / Printers</b>	<b>122</b>
Displays – Mammo .....	123
Displays – Color .....	123
Displays – Grayscale .....	124
DVD Import .....	124
DVD Burner .....	125
Printers .....	125

<b>Ultrasound</b>	<b>127</b>
-------------------	------------

<b>Testing Devices</b>	<b>137</b>
------------------------	------------

### Index of Advertisers

<b>Canon Medical</b> .....	cover / 129
<b>Cefla/NewTom</b> .....	13
<b>Dunlee</b> .....	17
<b>Fujifilm</b> .....	99
<b>Guerbet</b> .....	33
<b>Hologic</b> .....	inside front cover
<b>Konica Minolta</b> .....	111
<b>Medtron</b> .....	35
<b>Mindray</b> .....	133
<b>Siemens</b> .....	back cover
<b>Villa Sistemi</b> .....	89
<b>Ziehm</b> .....	41

## Simple, fast and targeted research on medical technology topics?

The online archive of **MED engineering** makes it possible!

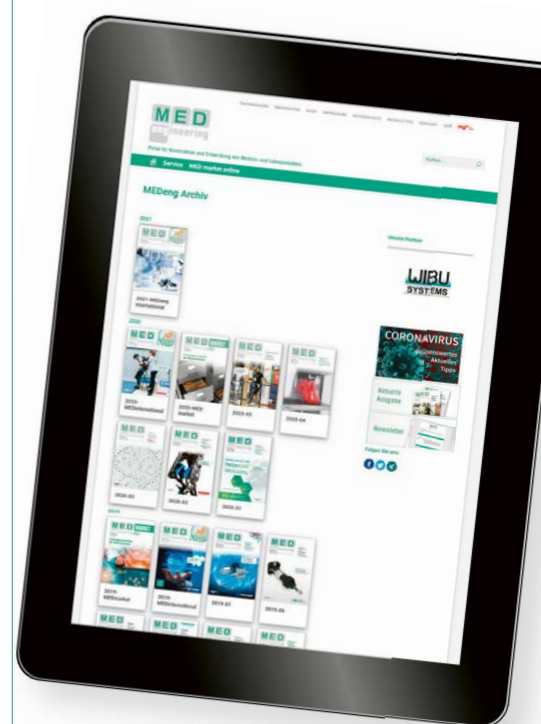

At [www.med-eng.de](http://www.med-eng.de) you will find this and older issues of **MED engineering** freely available to you. Start your digital research now!



# Computed Tomography

Photon-Counting  
Dual Source CT  
Volume CT  
20 to 64 Slices  
2 to 16 Slices  
Mobile CT  
Mammo CT  
Cone Beam CT  
Oncology CT  
Mobile CT Solutions  
Accessories /  
Complementary Systems

 **febromed**

**DUNLEE**

**GCTechnology GmbH**



**FUJIFILM**

**Planmed**

**PTW** THE  
DOSIMETRY  
COMPANY

**SIEMENS**  
**Healthineers**

**STERNMED**  
we make it possible

**ultrasound**  
**technologies**

**AB-CT**



**Canon**  
CANON ELECTRON TUBES & DEVICES CO., LTD.

**Canon**

Cone Beam CT 3D Imaging  
**NewTom**  
what's next

Photon-counting CT

**Siemens Healthineers · Naeotom Alpha**

<b>Power</b> 240 kW	<b>Gantry bore</b> 82 cm	<b>Scan speed</b> Up to 737 mm/s
------------------------	-----------------------------	-------------------------------------

**Highlights**

- World's first photon-counting CT system
- Dual Source CT with two QuantaMax photon-counting detectors
- Significant improvements in spatial resolution, image contrast, signal-to-noise ratio, dose efficiency
- Spectral information available in every scan, even at full scan speed and temporal resolution
- myExam Companion is an intelligent approach to simplify scanner operation
- Patient-friendly design with an 82 cm bore and a tablet-based mobile workflow to maximize patient proximity



- Expand patient reach, see finest details, have all relevant information available in single scan, ensure consistent measurements

Dual Source CT

**Siemens Healthineers · Somatom Force**

<b>Power</b> 240 kW	<b>Gantry bore</b> 78 cm	<b>Scan speed</b> Up to 737 mm/s
------------------------	-----------------------------	-------------------------------------

**Highlights**

- Bring image quality to the next level with Vectron X-ray tube
- Significantly reduced contrast media amounts required with low-kV imaging
- Ultra-low dose and free-breathing CT with outstanding native temporal resolution
- FAST integrated workflow with FAST 3D Camera to get two steps ahead in patient positioning



- Dual Source Dual Energy
- Dynamic imaging up to 80 cm
- Temporal resolution: 66 ms

**Siemens Healthineers · Somatom Drive**

<b>Power</b> 200 kW	<b>Gantry bore</b> 78 cm	<b>Scan speed</b> Up to 458 mm/s
------------------------	-----------------------------	-------------------------------------

**Highlights**

- Tin Filters – a new level of Care, bring CT doses to those expected in a routine X-ray series
- Straton MX Sigma X-ray tube with high power 70 & 80 enables lower doses with consistent image quality
- 10 kV steps allow for the most precise dose values for every single patient
- FAST integrated workflow with FAST 3D Camera drives precision in patient positioning



- Dual Source Dual Energy
- Dynamic imaging up to 48 cm
- Temporal resolution: 75 ms

Volume CT

**Canon · Aquilion One / Prism Edition**

<b>Power</b> 100 kW	<b>Gantry bore</b> 78 cm	<b>Scan range</b> 150 / 200 cm
------------------------	-----------------------------	-----------------------------------

**Highlights**

- Advanced intelligent Clear-IQ Engine (AiCE)
- Artificial intelligence in scanning and processing
- PUREVISION Optics imaging chain
- 0.275 s rotation
- 16 cm coverage
- 640 slices/rotation
- 0.17 mm spatial resolution
- SUREPosition patient centring
- Lateral table movement



- 300 kg patient table
- Super resolution cardiac imaging (PIQE)
- Spectral imaging with zero temporal offset
- Isophasic organ perfusion
- CT Fluoroscopy

**Canon · Aquilion One / Prism Edition 350**

<b>Power</b> 100 kW	<b>Gantry bore</b> 78 cm	<b>Scan range</b> 150 / 200 cm
------------------------	-----------------------------	-----------------------------------

**Highlights**

- Advanced intelligent Clear-IQ Engine (AiCE)
- Artificial intelligence in scanning and processing
- PUREVISION Optics imaging chain
- 0.35 s rotation
- 16 cm coverage
- 640 slices/rotation
- 0.17 mm spatial resolution
- SUREPosition patient centring
- Lateral table movement



- 300 kg patient table
- Super resolution cardiac imaging (PIQE)
- Spectral imaging with zero temporal offset
- Isophasic organ perfusion
- CT Fluoroscopy

**Canon · Aquilion One / Genesis Edition**

<b>Power</b> 100 kW	<b>Gantry bore</b> 78 cm	<b>Scan range</b> 150 / 200 cm
------------------------	-----------------------------	-----------------------------------

**Highlights**

- Advanced intelligent Clear-IQ Engine (AiCE)
- Artificial intelligence in scanning and processing
- PUREVISION Optics imaging chain
- 0.275 s rotation
- 16 cm coverage
- 640 slices/rotation
- 0.17 mm spatial resolution



- SUREPosition patient centring
- Lateral table movement
- 300 kg patient table
- SEMAR (Metal Artefact Reduction)
- Wide range of Cardiac and Dual Energy applications
- Isophasic organ perfusion

# Success Around the World

Dunlee's liquid metal bearing CT replacement tubes extend reach beyond USA and Europe with full registration in Canada and selected Middle Eastern countries.

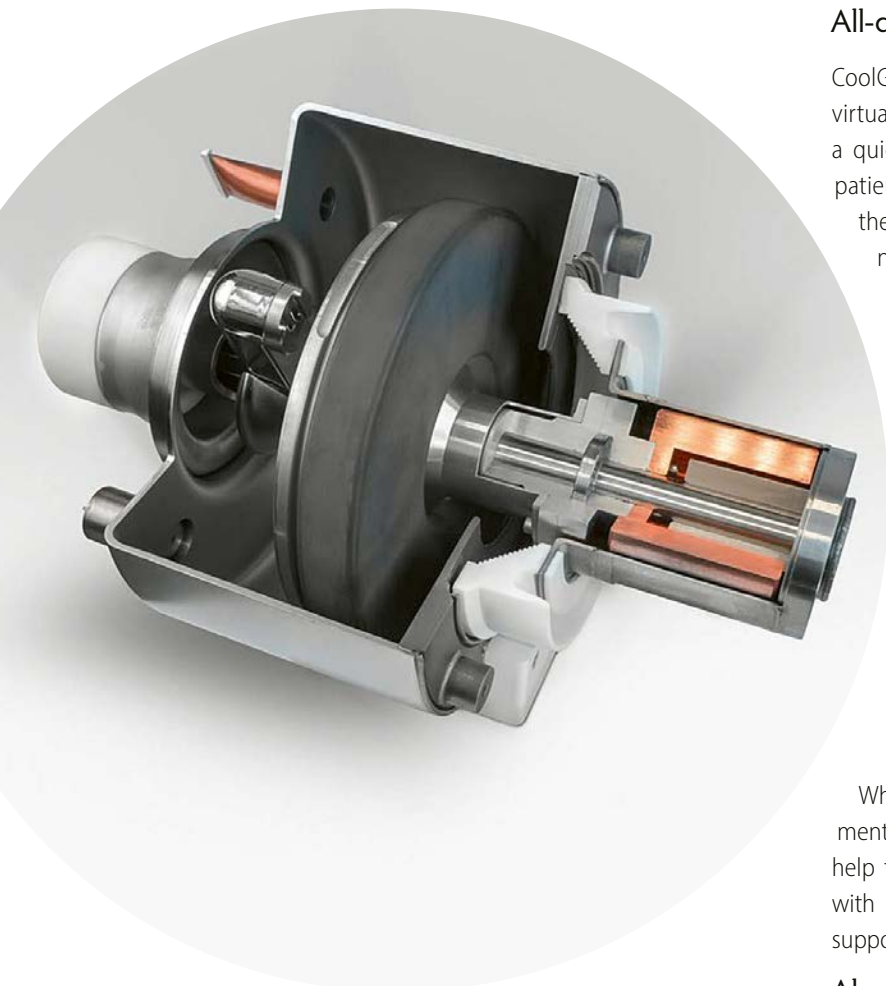

The DA200P40+LMB tube with Dunlee CoolGlide technology is proving its value with successful operation in hospitals in both the USA and Europe since the first installations in 2020. The feedback we've received is that service engineers like the easy installation, while radiologists like the smooth operation, and patients appreciate the quiet environment. It is now also registered in Canada and selected Middle Eastern countries, so you can offer this outstanding tube to your customers in many regions around the world.

## All-day operations and long life

CoolGlide is a liquid metal bearing technology that operates with virtually no wear for all-day operation and long life, and delivers a quieter sound pattern for smooth operation and a pleasant patient experience. The DA200P40+LMB tube was developed by the same team that was the first in the world to bring LMB technology to the X-ray market in 1989. With over 100,000 LMB units sold worldwide, the team built on its expertise when developing DA200P40+LMB with CoolGlide.

The tube is currently offered for the GE Revolution Evo and Optima 660 CT scanners. Future plans include validation for additional GE scanners.

## Manufactured in the USA

All DA200P40+LMB tubes are manufactured in Illinois, USA with imported parts. The liquid metal bearing with CoolGlide is designed and manufactured in Germany, based on knowledge gained from over 30 years of LMB technology development.

## Choose your partner of trust

When you offer your customers Dunlee's high-quality replacement tubes as an alternative to OEM CT replacement tubes, you help them manage costs and maintain scanner uptime. Partner with Dunlee for reliable tubes, friendly service and outstanding support.

## About Dunlee

Dunlee has over 100 years' experience in developing, producing and integrating innovative components for imaging systems. Serving both the OEM and replacement markets, Dunlee offers a comprehensive portfolio of reliable X-ray tubes, high voltage generators, detectors and product packages for CT, as well as solutions for interventional radiology, MRI and nuclear medicine. It offers support during development and throughout the product lifecycle, contributing to its customers' efficient production and go-to-market strategies. Visit [www.dunlee.com](http://www.dunlee.com) to learn more.

## Dunlee's LMB CT Replacement Tube

Successful installations in USA and Europe since 2020 show reliable tube performance

- Delivers reliable, quiet operation and long life for GE Revolution Evo and Optima CT660 CT scanners
- Successful installations attest to its quality engineering and manufacturing
- The DA200P40+ tube with CoolGlide liquid metal bearing technology now also has full registration in Canada and selected Middle Eastern countries



Volume CT

**Canon · Aquilion One / Genesis Edition 350**

<b>Power</b> 100 kW	<b>Gantry bore</b> 78 cm	<b>Scan range</b> 150 / 200 cm
------------------------	-----------------------------	-----------------------------------



**Highlights**

- Advanced intelligent Clear-IQ Engine (AiCE)
- Artificial intelligence in scanning and processing
- PUREVISION Optics imaging chain
- 0.35 s rotation
- 16 cm coverage
- 640 slices/rotation
- 0.17 mm spatial resolution
- SUREPosition patient centring
- Lateral table movement
- 300 kg patient table
- SEMAR (Metal Artefact Reduction)
- Wide range of Cardiac and Dual Energy applications
- Isophasic organ perfusion

**Canon · Aquilion Precision**

<b>Power</b> 72 kW	<b>Gantry bore</b> 78 cm	<b>Scan range</b> 170 / 200 cm
-----------------------	-----------------------------	-----------------------------------



**Highlights**

- Advanced intelligent Clear-IQ Engine (AiCE)
- Artificial intelligence in scanning and processing
- PUREVISION Optics imaging chain
- 2048 matrix reconstruction
- 0.1 mm spatial resolution
- 6 focal spot tube
- 0.35 s rotation
- Up to 320 slices/rotation
- SUREPosition patient centring
- Lateral table movement
- 300 kg patient table
- SEMAR (Metal Artefact Reduction)

**Canon · Aquilion Prime SP**

<b>Power</b> 72 kW	<b>Gantry bore</b> 78 cm	<b>Scan range</b> 150 / 200 cm
-----------------------	-----------------------------	-----------------------------------



**Highlights**

- Advanced intelligent Clear-IQ Engine (AiCE)
- Artificial intelligence in scanning and processing
- PUREVISION Optics imaging chain
- 0.23 mm spatial resolution
- 0.35 s rotation
- 4 cm coverage
- Up to 160 slices / rotation
- SUREPosition patient centring
- Lateral table movement
- 300 kg patient table
- SEMAR (Metal Artefact Reduction)
- Iterative 3D Fluoro
- Low dose cardiac scanning

**Canon · Aquilion Lightning SP**

<b>Power</b> 50.4 kW	<b>Gantry bore</b> 78 cm	<b>Scan range</b> 150 / 200 cm
-------------------------	-----------------------------	-----------------------------------



**Highlights**

- Advanced intelligent Clear-IQ Engine (AiCE)
- Artificial intelligence in scanning and processing
- PUREVISION low dose detector
- 0.25 mm spatial resolution
- 0.5 s rotation
- 4 cm coverage
- Up to 160 slices / rotation
- SUREPosition patient centring
- Lateral table movement
- 300 kg patient table
- SEMAR (Metal Artefact Reduction)
- vHP, variable helical parameters
- Iterative 3D Fluoro

**Fujifilm · Scenaria View**

<b>Power</b> 72 kW (84 kW optional)	<b>Gantry bore</b> 80 cm	<b>Scan range</b> 200 cm
--	-----------------------------	-----------------------------



**Highlights**

- Open design concept with aperture diameter of 800 mm
- New algorithms for iterative reconstruction: Intelli IPV
- SynergyDrive optimizes the workflow with Fujifilm's automation and acceleration technology
- Minimum scan time for all types of examination: 0.35 seconds/rotation
- Minimum slice thickness: 0.625 mm
- Unique laterally moving patient table (total: 200 mm)
- 650 mm wide patient table with weight limit of 250 kg
- Slices per rotation 64 / 128
- Dual Energy Scan

**Fujifilm · Supria 64 / 128**

<b>Power</b> 51 kW	<b>Gantry bore</b> 75 cm	<b>Scan range</b> 180 cm
-----------------------	-----------------------------	-----------------------------



**Highlights**

- 5 MHU X-ray tube
- Sub-second scan time for all examinations
- 0.625 mm minimum slice thickness
- 75 cm wide gantry bore for improved patient experience
- The compact footprint needs small installation space
- Iterative reconstruction algorithm for low dose examinations: Intelli IP Advanced
- Intuitive GUI design with 24-inch wide monitor
- Slices per rotation: 64 / 128
- System footprint: 13.5 m<sup>2</sup>



Aquilion Prime SP in the CT Hybrid with wall- and ceiling-art

# Mobile Imaging Solutions: Clinical Confidence Anywhere

The ever-changing healthcare environment comes with many challenges. The growing demand for flexible solutions is where we can contribute to the industry and offer different mobile imaging solutions to cover hospital, clinical and patient needs. To bridge new equipment installations, temporary high workloads, or long-term additional capacity, Canon Medical provides mobile solutions according to customers' needs and wishes.

Canon Medical's full fleet of Mobile Imaging Solutions is equipped with state-of-the-art medical equipment and technology. All that is required to take advantage of a mobile solution, is sufficient parking and power facilities. Canon Medical collaborates closely with its customers to find out what is required: whether it should be a Rapid Response solution that needs to be shipped overseas, a Hybrid solution that needs to be connected to a clinic or a City Hopper solution that will commute between hospital locations.

Currently, all Mobile Imaging Solutions are equipped with an Aquilion Prime SP CT\*, which includes an AI-assisted reconstruction technology named AiCE, short for Advanced intelligent Clear-IQ Engine. This is an innovative Deep Learning Reconstruction technology that has been trained to reduce noise and boost signal to deliver sharp, clear, and distinct images at speed. From fast patient throughput to robust cardiac scanning and new diagnostic capabilities, the Aquilion Prime SP is the CT system of choice for all imaging needs. The system empowers facilities to handle all patients from pediatric to bariatric, even the most challenging cases, while providing staff with a fast and efficient solution to make their work easier. And all that within a Mobile Imaging Solution; you get clinical confidence anywhere.

### ■ CT Rapid Response 2.0

*Outstanding performance wherever you need it*

CT imaging can play a critical role in managing patients under emergency conditions with unusually high workloads or in infection control situations. With the CT Rapid Response 2.0, Canon Medical offers a deployable imaging solution that enables uncompromising workflow and imaging performance as well as personal safety anywhere, anytime.

The solution can be transported quickly and easily by road, rail, sea, or air. Unloading and setting up is done in a minimum amount of time and the CT Rapid Response 2.0 immediately offers an uncompromising and ergonomic CT imaging solution.

In addition to a fully equipped and 360-degree lead protected CT scan room, the solution is built with hospital-grade wall and floor installations, making work efficient and safe for everyone.



CT Rapid Response 2.0

### ■ CT Hybrid

*State-of-the-art medical imaging at any location*

The CT Hybrid is designed to support the customer's need for a semi-permanent additional imaging solution. There is no need for high staircases or lifts as the solution is placed close to ground level, making it easily accessible for all staff and patients. A small two-step leads to the side entrance of the CT Hybrid, entering the solution directly at the patient dressing room and the staff's control room. For patients visiting the CT Hybrid in a wheelchair, on a stretcher, or bed, the back entrance is facilitated with a ramp, ensuring the easiest possible access. With the inside of the CT Hybrid being surprisingly spacious and fully equipped, it is a pleasure to work in for operators.

Due to the size and technical design of the CT Hybrid, transport is easily managed. Positioning the CT Hybrid at any location will be smooth sailing. Four built-in hydraulic legs will lift the solution off the trailer independently, leaving the only job for the driver to move the trailer away from under the solution.



CT Hybrid

### ■ CT City Hopper

*Interim solution that ensures 100% uptime*

With expandable sides, a patient staircase and elevator for easy access, this flexible solution can be placed close to your clinic or hospital. You can even use this solution to commute between different hospital locations as the CT City Hopper only needs an hour to be set up after arriving on site.

The City Hoppers are designed with user and patient experience in mind. Expandable sides make this solution feel spacious. Wall and ceiling art as well as dimmable color-lights and calming music will make sure that the patient has a relaxed and comfortable experience during their examination. For post-processing, the City Hoppers have Vitrea Advanced Visualization on board. Vitrea Advanced Visualization is a modular viewing platform that provides a broad range of functions with the option of adding more functionality when you need it.



CT City Hopper



For more information about Canon Medical's Mobile Imaging Solutions, please head to the website via the QR code or contact us via [eu.medical.canon](http://eu.medical.canon)



\* Upon request, other imaging modalities can be included in the Mobile Imaging Solutions

# Computed Tomography

## Volume CT

**Siemens Healthineers · Somatom X.ceed**

<b>Power</b> 120 kW	<b>Gantry bore</b> 82 cm	<b>Scan speed</b> Up to 216 mm/s
------------------------	-----------------------------	-------------------------------------



**Highlights**

- myExam Companion is an intelligent approach to simplify scanner operation
- myNeedle Companion supports targeted needle path planning and laser guidance
- FAST 3D Camera drives precision in patient positioning
- Patient-friendly design with an 82 cm bore and a tablet-based mobile workflow to maximize patient proximity
- High power, speed, spatial and temporal resolution (0.25 s rot.),

for advanced cardiac, spectral, emergency or Ultra High Resolution studies at low dose

**Siemens Healthineers · Somatom X.cite**

<b>Power</b> 105 kW	<b>Gantry bore</b> 82 cm	<b>Scan speed</b> Up to 218 mm/s
------------------------	-----------------------------	-------------------------------------



**Highlights**

- myExam Companion is an intelligent approach to simplify scanner operation
- myNeedle Companion supports targeted needle path planning and laser guidance
- FAST 3D Camera drives precision in patient positioning
- Patient-friendly design with an 82 cm bore and a tablet-based mobile workflow to maximize patient proximity
- Large power reserves of 1200 mA with low-kV and Tin Filter for

dose-optimized scanning even for bigger patients

- Cardiac, spectral and 4D imaging

**Siemens Healthineers · Somatom Edge Plus**

<b>Power</b> 100 kW	<b>Gantry bore</b> 78 cm	<b>Scan speed</b> Up to 230 mm/s
------------------------	-----------------------------	-------------------------------------



**Highlights**

- Tin Filters – bringing CT doses to those expected in a routine X-ray series
- FAST integrated workflow with FAST 3D Camera drives precision in patient positioning
- High power 70 & 80 and 10 kV steps helps to obtain high quality images despite large patient diversity
- Cardiac and 4D imaging at high quality and low dose
- TwinBeam Dual Energy without dose penalty

Pitch of up to 1.7 allows scanning of 230 mm/s thus minimizing motion artifacts

**Siemens Healthineers · Somatom go.Top**

<b>Power</b> 75 kW	<b>Gantry bore</b> 70 cm	<b>Scan speed</b> Up to 175 mm/s
-----------------------	-----------------------------	-------------------------------------



**Highlights**

- myExam Companion as unique approach in CT operation powered by AI, designed to optimize the exam to the individual patient
- Unique workflow solution with mobile workflow, GO Technologies and FAST 3D Camera
- Low-kV imaging, 10 kV steps, Tin Filter, Stellar detector and iterative reconstruction enable dose-optimized scanning
- High temporal resolution for excellent cardiac imaging

Holistic spectral imaging solution with TwinSpiral and TwinBeam Dual Energy

- System footprint: 4 m<sup>2</sup>

## 20 to 64 Slices

**Canon · Aquilion Lightning**

<b>Power</b> 50.4 kW	<b>Gantry bore</b> 78 cm	<b>Scan range</b> 148 / 198 cm
-------------------------	-----------------------------	-----------------------------------



**Highlights**

- Advanced intelligent Clear-IQ Engine (AiCE)
- Artificial intelligence in scanning and processing
- PUREVISION low dose detector
- 0.5 s rotation
- 2 cm coverage
- Up to 32 slices / rotation

- SUREPosition patient centring
- 300 kg patient table
- SEMAR (Metal Artefact Reduction)
- vHP, variable helical parameters
- SUREStart iterative bolus tracking
- Iterative 3D Fluoro

**Canon · Aquilion Start**

<b>Power</b> 36 kW	<b>Gantry bore</b> 78 cm	<b>Scan range</b> 153 / 183 cm
-----------------------	-----------------------------	-----------------------------------



**Highlights**

- AIDR 3D Enhanced iterative reconstruction
- Artificial intelligence in scanning and processing
- PUREVISION low dose detector
- 0.75 s rotation
- 1.6 cm coverage
- Up to 32 slices/rotation
- 220 kg patient table
- SEMAR (Metal Artefact Reduction)

- vHP, variable helical parameters
- SUREStart iterative bolus tracking
- SURESubtraction for superb iodine imaging

20 to 64 Slices

Fujifilm · FCT Speedia HD		
Power 72/108 kW	Gantry bore 75 cm	Scan range 175/195 cm



**Highlights**

- 5 MHU tube
- Sub-second scan time for all applications
- 0.675 mm minimum slice thickness
- Wide bore gantry for improved patient experience and operators' practice
- Compact footprint to maximize easiness of installation
- Advanced iterative reconstruction to allow low dose examinations

- Intuitive GUI with 24-inch color display
- Slices per rotation: 64/128
- System Footprint: 13.5 m<sup>2</sup>

Fujifilm · Supria 16/32		
Power 51 kW	Gantry bore 75 cm	Scan range 180 cm



**Highlights**

- 5 MHU X-ray tube
- Sub-second scan time for all examinations
- 0.625 mm minimum slice thickness
- 75 cm wide gantry bore for improved patient experience
- The compact footprint needs small installation space
- Iterative reconstruction algorithm for low dose examinations: Intelli IP Advanced

- Intuitive GUI design with 24-inch wide monitor
- Slices per rotation: 16/32
- Field of view: 500 mm

# New NEWTOM 7G WIDE.VISION

[www.newtom.it](http://www.newtom.it)

## NEW IMAGING HORIZONS.

Featuring a large gantry aperture, the NewTom 7G is the most advanced CBCT device on the market. From in-depth detail to the big picture.

**ULTRA-DETAILED MULTI-DIAGNOSTICS** Localised analysis over the entire body. Ray2D and 3D imaging up to 90 µm, also with radiocontrast agent. Artifact reduction and movement analysis using CineX and Cine-Scout. The eXtra Functions protocol extends the field of view longitudinally to analyse anatomical structures such as the spine and limbs.

**TECHNOLOGICAL EXCELLENCE** High power generator (120 kV – 20kW). High-sensitivity 3D panel and innovative algorithms for volumetric reconstruction. 77 cm gantry aperture.

**ERGONOMICS AND PRACTICALITY** Fully motor-powered table and 10" touch-screens, front and rear. Optimised examination flow thanks to certified NNT software with processing, sharing and RIS/PACS connectivity functions.

**MAXIMISING PATIENT CARE** The patient lies comfortably on the table and X-ray doses are always proportioned to the patient's build and the examination type thanks to SafeBeam™ technology.



# get up

## The swivelling handle system for radiology



reducing the physical strain of their job. As a result, the organisation as a whole benefits: since the actual physical strain on personnel is significantly reduced, employee sick leave due to back pain is also minimised.

### Safety for patients and health benefits for personnel

Febromed GmbH & Co. KG, the expert in delivery room equipment and medical accessories from Oelde, Germany, has developed 'get up', an innovative handle system for radiology. The new swivelling system was installed for the first time in a state-of-the-art CT scan room at the Institute of Diagnostic and Interventional Radiology and Neuroradiology at Essen University Hospital.

### For a secure grip

Many patients find getting onto the examination table for a CT scan difficult. In particular, restricted mobility leads to uncertainty as the patient is positioned and arranged, thus placing increased physical strain on care personnel, predominantly in the back area. The new 'get up' handle system from Febromed offers a solution: this swivelling system helps patients get onto the table before their scan and stand up again safely and comfortably afterwards. It minimises the risk of falling and provides a secure grip. It helps personnel by

### Positive experiences

After installing the handle system in May 2017, the Institute of Diagnostic and Interventional Radiology and Neuroradiology at Essen University Hospital has consistently had positive experiences. As Anton S. Quinsten, Chief radiographer, reports, "We are really happy with the 'get up' system from Febromed. The first few months have shown that the handle system is considered a real asset by both patients and personnel."

### Space-saving and durable

The 'get up' handle system is designed for space-saving mounting on the ceiling and can be swivelled by 360°. The structure can be locked in 15° increments so that the system is always in the optimal position for the patient. This purely mechanical construction ensures easy handling and extended durability.

[www.febromed.com](http://www.febromed.com)

20 to 64 Slices

**Siemens Healthineers · Somatom go.All**

<b>Power</b> 75 kW	<b>Gantry bore</b> 70 cm	<b>Scan range</b> Up to 200 cm
-----------------------	-----------------------------	-----------------------------------



**Highlights**

- myExam Companion as unique approach in CT operation powered by AI, designed to optimize the exam to the individual patient
- Unique workflow solution with mobile workflow, GO Technologies and FAST 3D Camera
- Low-kV imaging, 10 kV steps, Tin Filter, Stellar detector and iterative reconstruction enable dose-optimized scanning
- System footprint: 4 m<sup>2</sup>
- High temporal resolution and workflow automation facilitate easy cardiac examinations
- Holistic spectral imaging solution with TwinSpiral Dual Energy

**Siemens Healthineers · Somatom go.Up**

<b>Power</b> 32 kW	<b>Gantry bore</b> 70 cm	<b>Scan range</b> Up to 200 cm
-----------------------	-----------------------------	-----------------------------------



**Highlights**

- myExam Companion as unique approach in CT operation powered by AI, designed to optimize the exam to the individual patient
- Unique workflow solution with mobile workflow, GO Technologies and FAST 3D Camera
- Tin Filter technology enables ultra-low dose-optimized scanning at the levels of conventional X-ray
- The Stellar detector keeps electronic noise low and increases dose efficiency
- Holistic spectral imaging solution with TwinSpiral Dual Energy
- First level cardiac assessment supported by calcium scoring evaluation
- System footprint: 4 m<sup>2</sup>

**Siemens Healthineers · Somatom go.Now**

<b>Power</b> 32 kW	<b>Gantry bore</b> 70 cm	<b>Scan range</b> Up to 160 cm
-----------------------	-----------------------------	-----------------------------------



**Highlights**

- myExam Companion as unique approach in CT operation powered by AI, designed to optimize the exam to the individual patient
- Unique workflow solution with mobile workflow and GO Technologies
- Tin Filter technology enables ultra-low dose-optimized scanning at the levels of conventional X-ray
- The Stellar detector keeps electronic noise low and increases dose efficiency
- System footprint: 4 m<sup>2</sup>
- Longer lasting Chronon tube minimizes downtime and maximizes throughput
- Holistic spectral imaging solution with TwinSpiral Dual Energy

**Fujifilm · FCT Speedia**

<b>Power</b> 48 kW	<b>Gantry bore</b> 75 cm	<b>Scan range</b> 110 cm
-----------------------	-----------------------------	-----------------------------



**Highlights**

- 5 MHU tube
- Sub second scan time for all applications
- 0.675 mm minimum slice thickness
- Wide bore gantry for improved patient experience and operators' practice
- Compact footprint to maximize easiness of installation
- Advanced iterative reconstruction to allow low dose examinations
- Intuitive GUI with 24-inch color display
- Slices per rotation: 16 / 32
- System Footprint: 13.5 m<sup>2</sup>

**SternMed · Cytom 16 Eco**

<b>Power</b> 50 kW	<b>Gantry bore</b> 70 cm	<b>Scan range</b> 180 cm
-----------------------	-----------------------------	-----------------------------

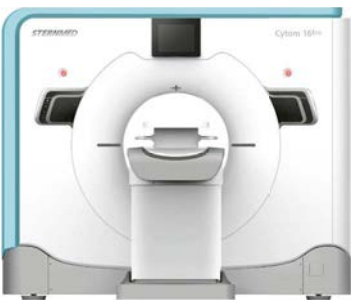

**Highlights**

- 0.5 s/360°, fully satisfied clinical actual demand
- Minimum slice thickness of 0.625 mm
- Ultra Fast rare earth ceramic detector collect 16 slices images
- 29184 detector units
- Coverage of each single scan is 20 mm
- Multiple X-ray dose reduction technology
- Intelligent scattering line automatic elimination technology
- 120 Second Non Stop scanning

**Siemens Healthineers · Somatom On.site**

<b>Power</b> 35 kW	<b>Gantry bore</b> 35 cm	<b>Slices</b> 32
-----------------------	-----------------------------	---------------------



**Highlights**

- Reduce in-hospital patient transports from the ICU to the radiology department by bringing the scanner to the patient instead of the other way around
- Consistent and reliable Somatom image quality at the point-of-care
- Stellar detector with low image noise for neuroimaging
- Iterative reconstruction and metal artifact reduction (iMAR and SAFIRE)
- Self-shielded system design for in-room patient scanning
- All-in-one concept with integrated accessories, e.g., shoulder board and head holder for neuroimaging
- Real mobility including integrated front camera for easy maneuvering

# RADBOOK 2022

Please visit us at  
**healthcare-in-europe.com**

## Mammo CT

### AB-CT · Advanced Breast-CT · nu:view

Pixel size	Scan time	Detector type
100 µm	7 – 12 s	Photon counting



#### Highlights

Leading edge breast CT

system for a revolutionary breast imaging experience

- Real 3D images with high isotropic resolution (voxel size: 150 µm)
- Superimposition-free, superb soft tissue differentiation
- Low dose in the range of mammograms
- Excellent patient comfort without compression
- Short scan and examination times
- Direct converting detector for highest sensitivity, accuracy and speed

## Cone Beam CT

### Cefla · NewTom 7G

FOV	Scan time	Pixel size
4 × 4 cm – 29 × 56 cm	7.2 – 26.0 s	90 – 500 µm



#### Highlights

Featuring a large gantry aperture, the 7G is the most advanced CBCT device on the market, applying Cone Beam technology for the first time to all areas of the body, including the spine, shoulder and hip. The 7G adapts FOVs and X-ray doses to the patient's build, and with a resolution of up to 90 µm, small complex structures such as the inner ear can be analysed with the utmost precision.

### Cefla · NewTom Giano HR Range

FOV	Scan time	Pixel size
4 × 4 cm – 16 × 18 cm	14 s	68 – 100 µm



#### Highlights

Efficiency and innovation in a device generating HR images to capture the smallest details.

Giano HR can be installed in one of three configurations:

- 3D Prime: 10 × 8 cm for all dental and implant planning needs
- 3D Advanced: 13 × 16 cm with FOV for maximum endodontic resolution to complete ENT analysis
- 3D Professional: 16 × 18 cm to investigate the entire dental-maxillofacial area and cervical spine

Now available with new-generation Direct Conversion technology for PAN and CEPH sensors

### Cefla · NewTom VGi evo

FOV	Scan time	Pixel size
5 × 5 cm – 24 × 19 cm	15 s	100 µm



#### Highlights

VGi evo combines technology, safety, comfort and a broad range of FOVs for acquisitions up to 24 × 19 cm. A wide range of volumetric, panoramic and teleradiographic examinations as well as dynamic X-rays are available. With the exclusive Eco Scan acquisition modes and SafeBeam technology, excellent image quality can be ensured with very low radiation doses to safeguard the patient's health.

### Planned Oy · Verity

FOV	Scan time	Pixel size
13 × 16 cm	18 s	127 µm



#### Highlights

- Cone Beam CT (CBCT) scanner dedicated to extremity and head and neck imaging
- Weight-bearing imaging
- kV range 80 - 96
- High quality 3D-imaging with Planmeca Ultra Low Dose
- Advanced artefact removal algorithms
- Compact, mobile, easy to site
- Motorized, soft-surface gantry adapts to the patient



Oncology CT

**Canon · Aquilion LB**

<b>Power</b> 72 kW	<b>Gantry bore</b> 90 cm	<b>Scan range</b> 150 / 200 cm
-----------------------	-----------------------------	-----------------------------------



**Highlights**

- 70 cm FOV
- 85 cm extended FOV
- Artificial intelligence in scanning and processing
- AIDR 3D iterative reconstruction
- PUREVISION low dose detector
- 0.5 s rotation
- 3.2 cm coverage
- Up to 32 slices/rotation
- 300 kg patient table
- SEMAR (Metal Artefact Reduction)
- SUREStart iterative bolus tracking
- Respiratory gating
- Iterative 3D Fluoro
- Oncology table top

**Canon · Aquilion Exceed LB**

<b>Power</b> 72 kW	<b>Gantry bore</b> 90 cm	<b>Scan range</b> 150 / 200 cm
-----------------------	-----------------------------	-----------------------------------



**Highlights**

- 70 cm FOV
- 90 cm extended FOV
- Advanced intelligent Clear-IQ Engine (AiCE)
- Artificial intelligence in scanning and processing
- 0.4 s rotation
- 4 cm coverage
- 160 slices/rotation
- Dual Energy applications
- SUREPosition patient centring
- CT Fluoroscopy
- Lateral table movement
- 300 kg patient table
- SEMAR (Metal Artefact Reduction)
- Respiratory gating
- Oncology table top

**Siemens Healthineers · Somatom Edge Plus**

<b>Power</b> 100 kW	<b>Gantry bore</b> 78 cm	<b>Scan speed</b> Up to 230 mm / s
------------------------	-----------------------------	---------------------------------------



**Highlights**

- High speed scan, reconstruction and post processing in RT routine
- Slices per rotation: 128
- Optimize image quality for every patient by combining DirectDensity and 10 kV steps
- Precise reduction of metal artifacts with iMAR
- Comprehensive motion management solutions for moving tumors
- Improve target delineation with TwinBeam and Dual Spiral Dual Energy scans
- Flexible CT imaging with Edge Plus Sliding Gantry



## DUNLEE'S LMB CT REPLACEMENT TUBE

Successful installations since 2020 shows reliable tube performance

- Delivers reliable, quiet operation and long life for GE Revolution™ Evo and Optima™ CT660 CT scanners
- Successful installations attest to its quality engineering and manufacturing
- The DA200P40+ tube with CoolGlide™ liquid metal bearing technology now also has full registration in Canada and select Middle Easter countries



**DA200P40+LMB**

Visit [dunlee.com](http://dunlee.com) to learn more



# Computed Tomography

## Oncology CT

**Siemens Healthineers · Somatom go.Open Pro**

<b>Power</b> 75 kW	<b>Gantry bore</b> 85 cm	<b>Scan speed</b> Up to 200 mm/s
-----------------------	-----------------------------	-------------------------------------

**Highlights**

- Direct i4D: First 4D CT scan mode to adapt to breathing patterns in real time for significant motion artifact reduction
- 4 cm detector coverage and 0,35 s rotation times for fast scanning, e.g., for deep inspiration breath-hold
- DirectORGANS: AI-powered organs-at-risk contouring directly at the CT console for automatic and consistent contouring
- TwinSpiral Dual Energy scanning and Tin Filter for advanced target contouring
- Direct Laser: Seamless integration of patient marking lasers and laser QA for time saving and error avoidance



- 227/307 kg patient table (TG-66 compliant) with flat table top
- Large bore of 85cm with 60 cm true scan Field of View; recon. slices per rotation: 128

**Siemens Healthineers · Somatom go.Sim**

<b>Power</b> 75 kW	<b>Gantry bore</b> 85 cm	<b>Scan speed</b> Up to 200 mm/s
-----------------------	-----------------------------	-------------------------------------

**Highlights**

- DirectORGANS: AI-powered organs-at-risk contouring directly at the CT console for automatic and consistent contouring
- Direct Laser: Seamless integration of patient marking lasers and laser QA for time saving and error avoidance
- Mobile workflow: Re-designed workflows with mobile tablet and Sim&GO technology to increase efficiency and patient comfort
- Precise target contouring with optimum kV imaging and a single calibration curve thanks to DirectDensity
- Comprehensive 4D workflow for respiratory motion management



- with FAST 4D
- 227 / 307 kg patient table (TG-66 compliant) with flat table top
- Large bore of 85 cm with 60 cm true scan field of view; recon. slices per rotation: 64

**Siemens Healthineers · Somatom go.Up RT**

<b>Power</b> 32 kW	<b>Gantry bore</b> 70 cm	<b>Scan speed</b> Up to 200 mm/s
-----------------------	-----------------------------	-------------------------------------

**Highlights**

- Precision for OAR contouring with AI-Rad Companion Organs RT
- Seamless and less error-prone processes thanks to the new mobile workflow with Sim&GO and Direct Laser Steering
- Confident tumor visualization thanks to automated metal artifact reduction with iMAR
- Precise target contouring with optimum kV imaging and a single calibration curve thanks to Direct-Density



- Comprehensive 4D workflow for respiratory motion management with FAST 4D
- 227 / 307 kg patient table (TG-66 compliant) with flat table top

## Mobile CT Solutions

**Canon Medical · CT City Hopper**

<b>System type</b> CT scanner*	<b>Deployment type</b> Trailer	<b>Deployment time</b> < 1 hour
-----------------------------------	-----------------------------------	------------------------------------



**Highlights**

The CT City Hopper is designed to bridge new equipment installations or temporary high workloads at hospitals or clinics. The trailer is equipped with an Aquilion Prime SP CT scanner which features the latest Advanced intelligent Clear-IQ Engine (AiCE) reconstruction. The design of the trailer, featuring expandable sides and patient lift for in-bed patients, allows high patient throughput without compromising on patient safety, workflow, or image quality.

*\* Upon request, other imaging modalities can be included in the CT City Hopper*

**Canon Medical · CT Rapid Response 2.0**

<b>System type</b> CT scanner	<b>Deployment type</b> Container base	<b>Deployment time</b> < 1 hour
----------------------------------	--	------------------------------------



**Highlights**

With the CT Rapid Response 2.0, Canon Medical offers a deployable imaging solution that enables uncompromising workflow and imaging performance as well as personal safety anywhere and at any time. This unit can be transported by air, sea, road, and rail to any location. The latest model CT scanner of your choice including the latest Advanced intelligent Clear-IQ Engine (AiCE) reconstruction technology enables the best possible imaging results even under challenging conditions.

**Canon Medical · CT Hybrid**

<b>System type</b> CT scanner*	<b>Deployment type</b> Hybrid	<b>Deployment time</b> < 1 hour
-----------------------------------	----------------------------------	------------------------------------



**Highlights**

Canon Medical's CT Hybrid is developed to support the need for a semi-permanent additional imaging solution. The CT Hybrid is easily accessible for all staff and patients because it's placed close to ground level. Inside, an Aquilion Prime CT scanner is installed, including Advanced intelligent Clear-IQ Engine (AiCE). Additionally, the solution is fully equipped with a contrast oven, a contrast injector and a Vitrea Advanced Visualization workstation to post-process images as requested making this a total solution.

*\* Upon request, other imaging modalities can be included in the Hybrid*

Accessories / Complementary Systems

Canon Electron Tubes & Devices · LM-CT Tube



**Highlights**

- For CT systems (2-MHU to 4-MHU)
- Uses a liquid metal bearing
- Supports 0.5 s full scans
- Our unique liquid metal bearing technology uses an all-metal target, enabling high anode heat dissipation with low noise and long bearing life

Dunlee · CT Replacement Tubes



**Highlights**

- Dunlee's CT replacement tubes:
- Meticulously engineered to be compatible with a variety of popular GE scanners
  - Offer excellent quality
  - Tube stocks at major airport hubs in the United States, Europe and Asia

Dunlee · CT Replacement Tube DA200P40+LMB



**Highlights**

The LMB DA200P40+LMB tube with Dunlee CoolGlide technology is specifically designed for use as a replacement tube on the GE Revolution Evo\* and Optima 660 CT\* scanners. Each tube is built according to the highest quality and regulatory standards.

\*The products listed may be trademarks of the OEM. For the latest information regarding the compatibility of CT replacement tubes and scanners, please refer to our cross-reference guide at [dunlee.com](http://dunlee.com)

Dunlee · Xpert CT Product Bundle



**Highlights**

- Most advanced solution in our CT portfolio
- Fast time-to-market: pre-integrated and calibrated CT8000 X-ray tube, generator, cooling unit and cables
- X-ray tube with CoolGlide Liquid Metal Bearing and Flat Emitter for fast workflow and high reliability
- Nearly arc-free; Less than 1 scan-interrupting arc in 3 years
- 16 cm coverage allows a single-rotation heart scan
- Enables fast gantry rotation: 0.27 sec (optional: 0.25 sec)
- High cooling capacity due to unipolar tube design
- Also available with CT6000 and CT6500 X-ray tubes

Dunlee · Xceed CT Product Bundle



**Highlights**

- Very reliable in high throughput environments
- Fast time-to-market: pre-integrated and calibrated CT4000 X-ray tube, generator, cooling unit and cables
- Provides CoolGlide Liquid Metal Bearing advantages in CTs with 4 cm coverage: high patient throughput and fast workflow
- The frictionless operation of CoolGlide Liquid Metal Bearings decreases wear, resulting in a much longer life than ball-bearing tubes for cost savings and differentiation in warranty and service models
- Also available with the CT3000 X-ray tube

Dunlee · 3D printed pure tungsten anti-scatter grids



**Highlights**

- Maximum design freedom
- Small feature size down to 80 μm
- Less X-ray scatter for premium image quality
- Improved and simplified assembly processes that save costs
- Access to top-level detection and grid design expertise to co-create from conceptualization to mass production



With Naeotom Alpha, Siemens Healthineers introduces the world's first photon-counting CT scanner.

## First CT scanner with photon-counting technology

Conventional CT imaging has reached its technical limitations: resolution can only be improved by small margins and dose cannot be reduced significantly. Photon-counting technology enables drastic improvements. These improvements include an increase in resolution and a reduction in radiation dose by up to 45 percent for ultra-high resolution (UHR) scans compared with conventional CT detectors with a UHR comb filter. This would be impossible with conventional detectors. Photon-counting scans contain more useable data, due to the fact that photon-counting technology directly detects each X-ray photon and its energy level instead of first converting it into visible light as with conventional CT imaging. Siemens Healthineers has launched Naeotom Alpha, the world's first photon-counting CT scanner for clinical use via CE Label and FDA 510k.

These aspects combined open up new capabilities, such as scanning a patient's lung at a high scan speed and getting high-resolution images with inherent spectral information – without the patient having to hold their breath. This spectral information also helps to identify materials inside the body that can even be removed from the image should they obstruct an area of interest. This helps physicians to assess issues quickly and offers the possibility to start treatment early. Through the reduction in radiation dose, regular examinations, such as lung cancer screenings using CT imaging can become routinely available for larger patient populations. And the high resolution reveals even small structures, taking clinical decision-making to a new level of confidence. The technical complexity of photon-counting CT imaging does not mean increased complexity for the user, thanks to myExam Companion from Siemens Healthineers.

“More than 15 years ago, work on photon-counting CT and this clinical vision started at Siemens Healthineers. We always believed in the tremendous clinical value and relentlessly worked on it together with our partners,” says Philipp Fischer, Head of Computed Tomography at Siemens Healthineers. “Today, with the introduction of Naeotom Alpha, we are taking a huge step in furthering patient care in a wide range of clinical domains by effectively showing things impossible to see with conventional CT scans. This required a radical rethinking of practically every technological aspect of computed tomography,” Fischer continues.

### Profound impact in many clinical fields

The clinical fields of cardiology, oncology, and pulmonology all have their own unique demands of medical images. In cardiac imaging, it is capturing the heart while moving, which therefore requires speed. Naeotom Alpha delivers speed thanks to its Dual Source design and benefits from spectral information and high resolution for removing obstructions caused by calcifications. This enables diagnostic assessment and allows more patients to benefit from CT imaging – even those with a high calcium burden. The high precision offered by Naeotom Alpha is also highly beneficial in oncology, where reliable and consistent evaluation of disease progress is the most important factor. Therefore, clinical images need to be as conclusive and consistent as possible to make the right decisions. In pulmonology, images need to contain all meaningful

answers in as few scans as possible to avoid delays in treatment and potentially severe consequences for patients. These needs are met and often exceeded by Naeotom Alpha’s features. Its clinical images inherently carry more information than ever possible before for precise diagnosis, follow-up, and treatment.

### Expanding the leading role of CT imaging in clinical decision-making

The implications of this innovation from Siemens Healthineers are far reaching for patients and physicians and may profoundly change the way that CT imaging is performed: It adds clinical value for fast and reliable diagnoses by the physician by improving image quality, potentially leading to less uncertainty for physicians and patients. The new technology helps in almost every clinical field, but especially when fine structures have to be evaluated.

More than 25 systems have already been installed and are used in clinical routine. So far, over 30,000 patients have been scanned. With a rotation speed of 250 milliseconds and two X-ray tubes and detectors (Dual Source), Naeotom Alpha is not only the first photon-counting CT system on the market but is also a very powerful, fast, and precise CT scanner.

[www.siemens-healthineers.com/naeotom-alpha](http://www.siemens-healthineers.com/naeotom-alpha)



© Courtesy of Medical University of South Carolina, Charleston, SC, USA

**Naeotom Alpha brings the first ever combination of dual source and photon-counting detector: Dual Source temporal resolution allows to scan patients at any heart rate. The addition of the photon-counting detector allows for spectral information and high-resolution. Bringing spectral imaging to the vessels enables to peek behind the curtain of calcium.**



© Erasmus Medical Center, Rotterdam, NL

**Different scan parameters as well as changes in the patient’s habitus are factors which can cause inconsistencies of measurements and potentially influence the evaluation of tumor response during treatment. The standard monoenergetic images provided by Naeotom Alpha in every scan allow radiologists to eliminate sources of imprecision.**

# ■ Computed Tomography

## Accessories / Complementary Systems

### Febromed · Get Up

The swivelling handle system for radiology offers the following highlights:

For the patients

- Independent moving
- Safe support in any position
- Safe motion for seniors and disabled people

For the staff

- Ergonomic working
- Reduced physical workload
- Fast changing of the sling



For the facility

- Various combinations with existing systems
- Small space requirement
- Mounting on wall, floor or ceiling on customer request

### GCTechnology GmbH · CIRS Phantoms

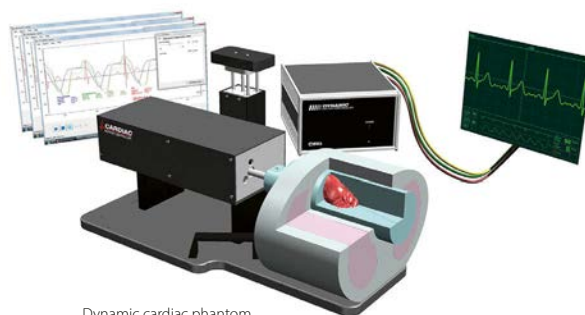

Dynamic cardiac phantom

#### Highlights

- Electron density phantom for calibration
- Dynamic lung phantom
- CT dose phantoms
- Bone analysis CT simulator
- Plastic water and tissue equivalent materials
- Spiral / helical CT phantom
- AAPM CT performance phantom
- 3D sectional torso phantom
- Head phantom

### I.A.E. · RTC 165



#### Highlights

- Replacement for GE Scanners: Sytec 6,000 / 8,000 Prospeed, Hispeed Dxi, Fxi, Lxi CT/i Advantage
- Reloaded in original CT Housing
- Careful refurbishing of original casing
- Replacing of all wear subject components
- Special cathode processing for reliable current emission
- Controlled thickness window for consistent HVL

### PTW · Cone-Beam Phantom



#### Highlights

- Testing the imaging performance of cone-beam and flat-panel CT scanners
- Provides different low contrast sections and spatial resolution bar patterns
- Allows MTF measurements in different orientations
- Two models available: basic and expert

### PTW · Thorax Phantom



#### Highlights

- For testing the influence of scan parameters in CT
- Includes spine and lung lobes
- Dosimetry option available
- Customizable

### Ultrasound Technologies · MedicCO<sub>2</sub>LON



#### Highlights

- Colonic insufflator for CT colonography. The MedicCO<sub>2</sub>LON provides automated colonic distension with CO<sub>2</sub> gas for CT colonography procedures, providing reliable colon distension while improving patient comfort.
- State-of-the-art design allowing ease of operation
  - Near silent operation
  - Large, colour touchscreen LCD
  - LED backlight and wide view angle
  - Compact, lightweight design
  - Multilingual interface
  - Locking connectors

# Magnetic Resonance Imaging



**Canon**

**DUNLEE**



**GCTechnology GmbH**

**FUJIFILM**



**SIEMENS Healthineers**

**STERNMED**  
we make it possible

PET / MRI  
7 Tesla  
3 Tesla  
1.5 Tesla  
High-V MRI (0.55 Tesla)  
Oncology  
Open  
MRI Coils  
Accessories /  
Complementary Systems

## PET / MRI

**Siemens Healthineers · Biograph mMR**

Gradient	Slewrate	Channels
45 mT/m <sup>1</sup>	200 T/m/s <sup>1</sup>	Up to 102×32

<sup>1</sup>Maximum gradient amplitude and slewrate can be applied simultaneously



**Highlights**

- Largest customer base of installed PET/MR systems worldwide
- State-of-the-art 3T MRI with 2nd order shim
- Comprehensive set of surface coils available for full range of MR-only exams
- Not only simultaneous, but synergistic PET/MR: MR-based motion compensation of PET images
- Whole-body MR-based PET attenuation correction including major bones
- Up to 10 bed positions with PET/MR
- Available with *syngo* MR E11 software

## 7 Tesla

**Siemens Healthineers · Magnetom Terra**

Gradient	Slewrate	Channels
80 mT/m <sup>1</sup>	200 T/m/s <sup>1</sup>	Up to 64×64

<sup>1</sup>Maximum gradient amplitude and slewrate can be applied simultaneously



**Highlights**

- World's first 7T MRI scanner released for clinical use
- Dual Mode – secure switch between research and clinical operation\*
- 50 percent lighter 7T magnet technology\*\* for easier integration into clinical environments
- Double SNR for more precision\*\*\*
- XR 80/200 gradients; up to 16 channel parallel transmit in research mode
- Submillimeter BOLD fMRI precision for pre-surgical evaluation
- Available with *syngo* MR E12 software
- Additional metabolic information with <sup>23</sup>Na imaging and <sup>31</sup>P spectroscopy

\*Research mode as part of dual mode is available as an option and not intended for clinical use  
\*\*Compared to previous 7T generation \*\*\*Compared to 3T systems

## 3 Tesla

**Canon · Vantage Galan 3T**

Gradient	Slewrate	Channels
33 / 45 mT/m	200 mT/m/s	128



**Highlights**

- Patient friendly 71 cm wide bore and silent scanning with Pianissimo Zen
- Fully integrated Deep Learning Reconstruction: Advanced intelligent Clear-IQ Engine (AiCE). AiCE produces exceptionally detailed MR images with high SNR
- Auto Scan Assist solutions for automated scan-planning and increased productivity
- Next generation scan techniques
- Enhanced throughput with Compressed SPEEDER, dockable table and live planning tool ForeSee View

**Siemens Healthineers · Magnetom Prisma**

Gradient	Slewrate	Channels
80 mT/m <sup>1</sup>	200 T/m/s <sup>1</sup>	Up to 204×128

<sup>1</sup>Maximum gradient amplitude and slewrate can be applied simultaneously



**Highlights**

- A unique MR design driving innovation in research applications
- Unique scanner technology in one package: benchmark 3T magnet homogeneity; highest gradient amplitude and performance with XR 80 / 200 gradients; advanced parallel transmit technology for zoomed imaging and ultra-high coil element density with Tim 4G designed for maximum SNR and extreme iPAT
- Driving the largest and most active MRI research network
- Latest applications available with *syngo* MR XA30 software

**Siemens Healthineers · Magnetom Vida with BioMatrix**

Gradient	Slewrate	Channels
Up to 60 mT/m <sup>1</sup>	200 T/m/s <sup>1</sup>	Up to 228×128

<sup>1</sup>Maximum gradient amplitude and slewrate can be applied simultaneously



**Highlights**

- The first MRI scanner with BioMatrix technology
- An all-new, 3T magnet with a large Field-of-View of 55 × 55 × 50 cm<sup>3</sup>
- Up to 60 / 200 XT gradients – for up to 25 percent higher SNR for DWI
- Free-breathing examinations with Turbo Suite Elite
- Simultaneous Multi-Slice and Compressed Sensing for 2D and 3D imaging
- With Deep Resolve, our new AI-powered advanced image reconstruction technology
- Explore new diagnostic frontiers based on quantitative information with MR Fingerprinting
- Latest applications available with *syngo* MR XA50A

**Siemens Healthineers · Magnetom Lumina with BioMatrix**

Gradient	Slewrate	Channels
36 mT/m <sup>1</sup>	200 T/m/s <sup>1</sup>	180×32

<sup>1</sup>Maximum gradient amplitude and slewrate can be applied simultaneously



**Highlights**

- New 3T magnet with 70 cm open bore and large 55 × 55 × 50 cm<sup>3</sup> FoV
- Unique BioMatrix technology automatically adjusts to patient biovariability
- With Deep Resolve, our new AI-powered advanced image reconstruction technology
- New Turbo Suite acceleration packages enable up to 50%\* faster clinical routine examinations
- GO technologies powered by artificial intelligence boost patient throughput
- Latest applications available with *syngo* MR XA50A

\*Data on file



1.5 Tesla

**Canon · Vantage Fortian 1.5T**

Gradient	Slewrate	Channels
33 mT/m	155 mT/m/s	128



**Highlights**

- Patient friendly 71 cm wide bore and silent scanning with Pianissimo Zen
- Fully integrated Deep Learning Reconstruction: Advanced intelligent Clear-IQ Engine (AiCE). AiCE produces exceptionally detailed MR images with high SNR
- Auto Scan Assist solutions for automated scan-planning and increased productivity
- Easy to clean gloss coating aids sterilization and disinfection requirements
- Enhanced workflow with WalkLink Solutions. Tablet UX to move MR console anywhere and ceiling camera to automate patient positioning
- This product will be available on our website soon

**Canon · Vantage Orián 1.5T**

Gradient	Slewrate	Channels
35/45 mT/m	155/200 mT/m/s	128



**Highlights**

- Patient friendly 71 cm wide bore and silent scanning with Pianissimo Zen
- Fully integrated Deep Learning Reconstruction: Advanced intelligent Clear-IQ Engine (AiCE). AiCE produces exceptionally detailed MR images with high SNR
- Auto Scan Assist solutions for automated scan-planning and increased productivity
- Next generation scan techniques
- Enhanced throughput with Compressed SPEEDER, dockable table and live planning tool ForeSee View

**Canon · Vantage Elan NX Edition**

Gradient	Slewrate	Channels
33 mT/m	125 mT/m/s	64



**Highlights**

- Patient friendly 63 cm open bore with 55 × 55 × 50 cm spherical scan area
- Fully integrated Deep Learning Reconstruction: Advanced intelligent Clear-IQ Engine (AiCE). AiCE produces exceptionally detailed MR images with high SNR
- Auto Scan Assist solutions for automated scan-planning and increased productivity
- Enhanced throughput with Compressed SPEEDER, Fast3D and live planning tool ForeSee View
- Low total power requirement of 25 kVA

**Fujifilm · Echelon Smart Plus**

Gradient	Slewrate	Channels
33 mT/m	130 T/m/s	16



**Highlights**

- IP-Rapid, the latest Iterative processing technology, reduces time of routine scans by up to 50 percent
- SynergyDrive optimizes the workflow with Fujifilm's automation and acceleration technology (AutoPose, AutoExam, AutoClip)
- SoftSound Suite to reach 96 percent sound pressure reduction at maximum

**Fujifilm · Echelon Smart**

Gradient	Slewrate	Channels
33 mT/m	130 T/m/s	16



**Highlights**

- "SmartQuality" for superb clinical images and sophisticated applications
- "SmartSpeed" for reduced examination time
- "SmartComfort / SoftSound Suite" for an extraordinary quiet patient experience
- "SmartECO" for low running costs
- "SmartSpace" to offer the smallest possible installation footprint
- Field strength: 1.5 T

**Siemens Healthineers · Magnetom Sola Cardiovascular Edition**

Gradient	Slewrate	Channels
45 mT/m <sup>1</sup>	200 T/m/s <sup>1</sup>	204 × 64

<sup>1</sup>Maximum gradient amplitude and slewrate can be applied simultaneously



**Highlights**

- A dedicated MRI scanner designed to meet the demands of cardiovascular examinations
- Free-breathing CMR exams with Compressed Sensing Cardiac Cine for functional imaging even for patients with arrhythmias or those who cannot hold their breath
- Tissue characterization with MyoMaps and HeartFreeze for differential diagnosis of myocardial injury
- Consistent results, fast with BioMatrix Sensors and the AI-powered Cardiac
- Dot Engine for fast patient setup and step-by-step guidance for CMR exams in as little as 30 minutes\*
- Latest applications available with syngo MR XA31A

\* Data on file, results may vary

# Magnetic Resonance Imaging

## 1.5 Tesla

**Siemens Healthineers · Magnetom Sola with BioMatrix**

Gradient	Slewrate	Channels
Up to 45 mT/m <sup>1</sup>	Up to 200 T/m/s <sup>1</sup>	Up to 204 × 64

<sup>1</sup>Maximum gradient amplitude and slewrate can be applied simultaneously



**Highlights**

- 70 cm open bore with 50 × 50 × 50 cm<sup>3</sup> FoV
- Unique BioMatrix technology automatically adjusts to patient biovariability
- Ten unique Dot Engines provide highly automated scan procedures
- Free-breathing examinations with Turbo Suite Elite
- Simultaneous Multi-Slice and Compressed Sensing for 2D and 3D imaging

- With Deep Resolve, our new AI-powered advanced image reconstruction technology
- Latest applications available with syngo MR XA31A

**Siemens Healthineers · Magnetom Amira**

Gradient	Slewrate	Channels
33 mT/m <sup>1</sup>	125 T/m/s <sup>1</sup>	96 × 16

<sup>1</sup>Maximum gradient amplitude and slewrate can be applied simultaneously



**Highlights**

- Increase patient satisfaction with complete, quiet neurological and orthopedic exams
- Right timing and motion insensitive techniques for liver exams with FREEZEit
- 10-min exams with best-practice-based protocols
- Up to 30% energy savings in standby mode with Eco-Power
- Increased throughput with Tim 4G and DotGO

- Maximizing return due to minimized siting requirements and costs
- Available with syngo MRXA12 software for applications such as Compressed Sensing, SMS, and many more

**Siemens Healthineers · Magnetom Altea with BioMatrix**

Gradient	Slewrate	Channels
33 mT/m <sup>1</sup>	125 T/m/s <sup>1</sup>	180 × 32

<sup>1</sup>Maximum gradient amplitude and slewrate can be applied simultaneously



**Highlights**

- 70 cm open bore with 50 × 50 × 50 cm<sup>3</sup> FoV
- Unique BioMatrix technology automatically adjusts to patient biovariability
- 50 percent\* faster clinical routine examinations with Turbo Suite
- GO technologies powered by AI to boost patient throughput
- Latest applications available with syngo MR XA31A

- With Deep Resolve, our new AI-powered advanced image reconstruction technology

\*Data on file

**Siemens Healthineers · Magnetom Amira with BioMatrix**

Gradient	Slewrate	Channels
33 mT/m <sup>1</sup>	125 T/m/s <sup>1</sup>	Up to 96 × 24

<sup>1</sup>Maximum gradient amplitude and slewrate can be applied simultaneously



**Highlights**

- Unique BioMatrix technology automatically adjusts to patient biovariability
- Boost productivity with Turbo Suite, Simultaneous Multi-Slice, and GO applications
- Increased patient access to advanced MRI exams with free-breathing exams
- GO technologies powered by artificial intelligence boost patient throughput

- Save energy consumption with Eco-Power
- Increased consistency and workflow acceleration with DotGO and GO technologies
- Available with syngo MR XA12 software

**Siemens Healthineers · Magnetom Sempra**

Gradient	Slewrate	Channels
30 mT/m <sup>1</sup>	100 T/m/s <sup>1</sup>	Up to 96 × 16

<sup>1</sup>Maximum gradient amplitude and slewrate can be applied simultaneously



**Highlights**

- 10-min exams with best-practice-based protocols
- Up to 30% energy savings in standby mode with Eco-Power
- Increased throughput and consistency with Brain, Spine and Large Joint Dot engines
- More patient comfort with ultra-light-weight Tim 4G coils and Quiet Suite
- Expand clinical offerings with advanced trendsetting applications
- Latest applications available with syngo MR XA12 software such as Compressed Sensing, SMS, and many more

- Increased consistency and workflow acceleration with DotGO and GO technologies

**SternMed · Marcom 1.5T**

Gradient	Slewrate	Channels
40 mT/m	150 T/m/s	16

**Highlights**

- Short cavity magnet with zero helium consumption
- Fully digitalized multi-channel spectrometer
- 4K cold head technology
- Multi-channel PA RF receiving coil with intelligent identification
- Image reconstruction speed 1,500 fps
- Maximum gradient field and slew rate reached at the same time
- Parallel acquisition technology platform
- Patient table can be controlled by machine in case of emergency



## High-V MRI (0.55 Tesla)

### Siemens Healthineers · Magnetom Free.Max

#### Highlights

- First 80 cm patient bore: Accessibility for claustrophobic and obese patients
- The most compact whole-body MRI-platform for greater siting flexibility
- High-V MRI platform: For everyday excellence and new clinical opportunities
- DryCool magnet: 0.7 liters of liquid helium / No quench pipe
- Blanket-like contour coils for comfort and flexibility



- Intuitive operation for any level of experience with myExam Autopilot
- Available as turnkey container solution\*

\*The turnkey solution is still under development and not commercially available yet. It is not for sale in the U.S. Its future availability cannot be guaranteed. The information shown herein refers to products of 3rd party manufacturer's and thus are in their regulatory responsibility. Please contact the 3rd party manufacturer for further information.

### Siemens Healthineers · Magnetom Free.Star<sup>®</sup>

#### Highlights

- Disruptively simple approach to MRI based on the revolutionary High-V MRI platform
- Enhanced accessibility to MRI through redefined lifecycle costs
- The most compact whole-body MRI-platform for greater siting flexibility
- DryCool magnet: 0.7 liters of liquid helium / No quench pipe
- Intuitive operation for any level of experience with myExam Autopilot



- Available as turnkey container solution\*\*

\*Magnetom Free.Star and its turnkey solution are still under development and not commercially available yet. It is not for sale in the U.S. Its future availability cannot be guaranteed.

\*\*The information shown herein refers to products of 3rd party manufacturer's and thus are in their regulatory responsibility. Please contact the 3rd party manufacturer for further information.

## Oncology

### Siemens Healthineers · Magnetom RT Pro Edition

#### Highlights

- Support precision in RT with Magnetom Sola, or Vida and trendsetting applications such as RESOLVE, StarVIBE or Compressed Sensing GRASP-VIBE
- Scan patients consistently in the treatment position with dedicated RT positioning equipment (CIVCO, Orfit, Qfix), and MR compatible laser bridge (LAP)
- Rely on intuitive and dedicated RT workflows with RT Dot Engine and RT Image Suite



- Enable an MR-only RT planning workflow with RT Dot Engine and RT Image Suite's Synthetic CT feature
- Caption organ motion in abdomen and thorax under free-breathing with automatic respiratory phase sorting with 4D MRI-RT Respiratory Self-Gating

## Open

### Fujifilm · Aperto Lucent Plus

Gradient	Slewrate	Channels
25 mT/m	55 T/m/s	2

#### Highlights

- Wide, 320° open permanent MRI system
- Features premium field strength amongst the permanent MRI systems presently on the market
- New generation open MRI with SynergyDrive contains IP-RAPID iterative reconstruction technology, AutoExam with automatic slice positioning and all around RADAR motion artifact reduction



- Fast processing chain allows increasing patient throughput
- Reduced running costs allowing fast return of investment
- Field strength: 0.4 T

### Fujifilm · Airis Vento Plus

Gradient	Slewrate	Channels
22 mT/m	55 T/m/s	2

#### Highlights

- Comfort class permanent open MRI system, which keeps enhanced capabilities meeting sophisticated open design
- Offers newly developed technologies available at an excellent cost of ownership
- New generation open MRI with SynergyDrive contains IP-RAPID iterative reconstruction technology, AutoExam with automatic slice positioning and all around RADAR motion artifact reduction



- Environment friendly: extremely low power consumption and reduced installation requirements
- Low running costs allowing fast return of investment
- Field strength: 0.3 T

### Fujifilm · Oasis Velocity

Gradient	Slewrate	Channels
33 mT/m	100 T/m/s	16

#### Highlights

- World's most powerful open MRI
- Vertical field superconductive magnet for high SNR
- 270° panoramic view, accommodates claustrophobic, paediatric, obese patients
- Fully motorized extra wide 82 cm patient table (up to 300 kg)



- Two-pillar asymmetric design
- Soft Sound Technology
- New generation open MRI with SynergyDrive contains IP-RAPID iterative reconstruction technology, AutoExam with automatic slice positioning and all around RADAR motion artifact reduction
- Field strength: 1.2 T

# Magnetic Resonance Imaging

## Open

**SternMed · Marcom 0.35T**

Gradient	Slewrate	Channels
25 mT/m	75 T/m/s	4



**Highlights**

- Fully open magnet
- 4D shimming
- Eddy Zero technology
- Self-regulating constant temperature
- Fully digital 4-channel receiving spectrometer
- Automatic coil tuning
- Accurate position assist
- Use of advanced active shimming algorithm for real-time automatic shimming on each examination
- Higher SNR
- Higher resolution
- Less scanning time
- Comprehensive scanning sequences
- Advanced imaging techniques
- Five standard coils and more than seven optional coils

**SternMed · Marcom 0.5T**

Gradient	Slewrate	Channels
25 mT/m	75 T/m/s	4

**Highlights**

- Fully open C-shaped
- 2-column magnet
- 4D shimming
- Eddy Zero technology
- Self-regulating constant temperature
- Fully digital 4-channel receiving spectrometer
- Automatic coil tuning
- Accurate position assist
- Use of advanced active shimming algorithm for real-time automatic shimming on each examination
- Higher SNR
- Higher resolution
- Less scanning time
- Comprehensive scanning sequences
- Advanced imaging techniques
- Five standard coils and more than seven optional coils

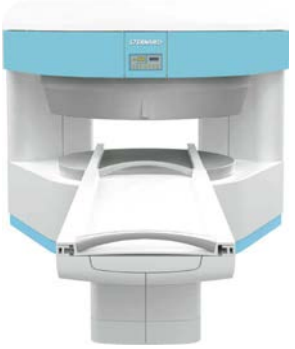

## MRI Coils

**Dunlee · Invivo Sentinelle Breast Coils**



**Highlights**

More than 30 years experience in MRI RF coils

- Variable coil geometry to fit individual patients
- Ergonomic design that allows easy workflow
- High signal-to-noise ratios to support advanced imaging applications
- Wide range of MR biopsy disposables (grids, needle blocks/sleeves, markers, holders, phantom, etc.)

**Noras · Encompass 15-Channel Head Coil**

Field strength	Channels	System platform
3 T	15	Siemens



**Highlights**

- Dedicated head coil for high-resolution, used in combination with a radiotherapy mask
- MRI control before and after stereotactic radiotherapy
- High-resolution MR diagnostics of head and neck
- Transversal, sagittal, coronal and tilted images possible
- Removable double mirror for claustrophobic patients

**Noras · Mandibula 15-Channel Dental Coil**

Field strength	Channels	System platform
3 T	15	Siemens

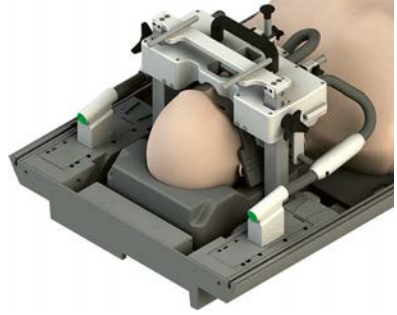

**Highlights**

- High-resolution dedicated MR imaging in dental area
- Easy to position and adjustable for each patient
- Excellent patient comfortability
- Reduced scan times with higher image quality
- Optional mirror attachable for claustrophobic patients

**Noras · BI 6 Comfort Coil**

Field strength	Channels	System platform
1.5/3T	6	Siemens



**Highlights**

- Increased comfort due to more padded patient support and dedicated height-adjustable forehead support
- Adaptation to breast volume due to height-adjustable positioning of the patient
- Cranio-caudal fixation of the breasts for optimized diagnostic imaging
- High-resolution image quality with high homogeneity
- Very good illumination of the axilla
- Integrated LED light system provides an optimally illuminated working environment to support your biopsy workflow
- Flexible and wide access for breast biopsy
- Compatible with the established biopsy units from Noras

MRI Coils

**Noras · OR Head Holder Lucy & OR Head Coil**

Field strength	Channels	System platform
1.5/3 T	8	Siemens

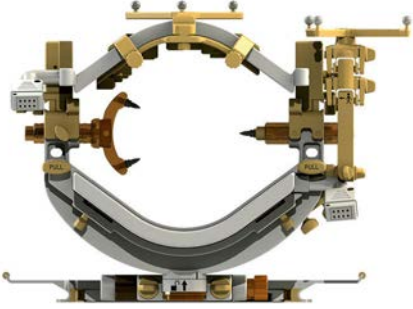

**Highlights**

- MR and X-ray compatible for multi-modal applications
- Excellent image quality and homogeneity
- Three-point fixation with integrated force indicator
- Removable and height-adjustable lower coil
- Excellent access to the field of intervention

**Noras · Variety 16-Channel Multipurpose Coil**

Field strength	Channels	System platform
1.5/3 T	16 (2x8)	Siemens

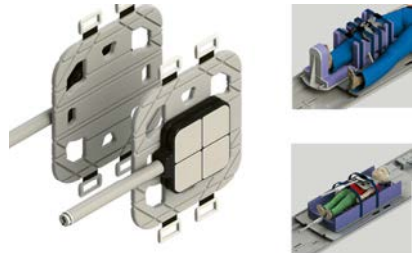

**Highlights**

- Application for diagnosis in orthopedics, pediatrics and veterinary medicine
- High signal quality based on a design with 8+8 array elements with high coil element density
- High-resolution examinations of even small body regions with reduced scan times
- Slim design and optional dedicated positioning aids enable coil placement close to anatomy of interest

healthcare-in-europe.com

Stay informed

News  
Reports  
Interviews  
Videos  
Social Media



## Accessories / Complementary Systems

### allMRI GmbH · MRI Safe Handheld Metal Detector

#### Highlights

- The only handheld MRI patient screening device capable of separately detecting both ferrous and non-ferrous metallic items
- Non-magnetic construction is ideal for operation in Zone IV at 3 Tesla
- Large search area for quick, accurate screening



### allMRI GmbH · MRI Waste Bin 2x 45 Liter

#### Highlights

- MRI safe plastic bin 2x 45 Liters in total 90 Liters
- With foot pedal
- 100 mm castors
- Push-bar
- Optional colored lids green, blue, red and yellow



### allMRI GmbH · One-way Head Rest Covers for MRI Breast Coils

#### Highlights

- Fits on a variety of headrests of MRI breast coils
- Hook-and-loop fasteners on bottom hold cover in place
- Soft and comfortable
- Latex free
- MR safe



### allMRI GmbH · Foldable MRI wheelchair

#### Highlights

- MRI safe foldable wheelchair
- Entirely made of 100% thermoplastic
- Including the ball bearing
- Two swing-out adjustable footrests and armrests
- Solid rubber tires



### Febromed · Get Up

#### The swivelling handle system for radiology offers the following highlights:

- For the patients
- Independent moving
  - Safe support in any position
  - Safe motion for seniors and disabled people
- For the staff
- Ergonomic working
  - Reduced physical workload
  - Fast changing of the sling



- For the facility
- Various combination with existing systems
  - Small space requirement
  - Mounting on wall, floor or ceiling on customer request

### GCTechnology · CIRS Phantoms

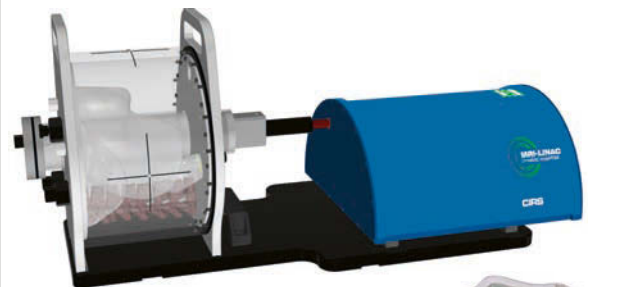

#### Highlights

- Large field MRI distortion phantom
- Distortion check software
- 3D triple modality phantoms suitable for MR: abdominal, breast, prostate and lumbar phantom



# Injectors

Guerbet | 

MED (TRON<sup>®</sup>) AG

 **Transatlantic**  
Produkte für eine heile Welt

# Injectors

## Injectors

### Guerbet · OptiVantage Single Use

Application	Pressure	FlowRate
CT	22.4 bar	0.1–10 ml/s

**Highlights**  
 Dual head CT contrast delivery system

- Scan delay, phase delay, auto-fill, auto purge
- Timing bolus, inject delay, patency check
- Fully programmable touchscreen powerhead
- Scanner interface to CAN Open Class 4\*
- OptiBolus bolus shaping software extends the window of imaging opportunity
- Configurations:
  - Pedestal and ceiling mount options
- Loading, filling & priming: Automatic / manual
- Simultaneous injection: 10% – 90% (5% steps)
- Heater: 37° ± 3°
- Connectivity with Contrast&Care (optional)

*Components and consumables certified by the manufacturer*      \* dependent on scanner manufacturer



### Guerbet · FlowSens

Application	Pressure	FlowRate
CT	21 bar	0.3 – 10 ml/s

**Highlights**  
 Syringeless CT contrast delivery system

- Advanced touchscreen interface
- Only few seconds between patients
- 12H manyFlow (closed pre-connected day set)
- Secufill patient line (scientific study on demand)
- All available media containers
- Check-valves (no backflow)
- 4 Air sensors
- Temperature maintenance
- Pressure monitoring: graphical and numerical

• Simultaneous injection (optional): 20 – 80 %

- Vein test
- Loading, filling & priming: Automatic
- Configurations: pedestal & ceiling
- Connectivity with Contrast&Care (optional)

*Components and consumables certified by the manufacturer*



### Guerbet · OptiOne

Application	Pressure	FlowRate
CT	22.4 bar	0.1–10 ml/s

**Highlights**  
 Single head CT contrast delivery system

- Compatible with prefilled syringes & vials
- Scan delay, phase delay, auto-fill, auto purge
- Timing bolus, inject delay
- Fully programmable touchscreen powerhead
- Scanner relay interface as standard
- OptiBolus bolus shaping software extends the window of imaging opportunity
- Configurations:
  - Pedestal and ceiling mount
- Loading, filling & priming: automatic / manual
- Heater : 37° ± 3°
- Connectivity with Contrast&Care (optional)

*Components and consumables certified by the manufacturer*



### Guerbet · OptiVantage Multi-Use

Application	Pressure	FlowRate
CT	22.4 bar	0.1–10 ml/s

**Highlights**  
 Dual head CT contrast delivery system  
 When efficiency and care combine seamlessly

- Newly designed multi-use interface
- All in one preconnected 24 hours dayset, with closed system, air & particles filters
- Secufill patient line with double safety valve
- Only a few seconds preparation between patients
- Certified syringes & manyFill dayset
- Countdown timer to alert you of compliancy with hygiene regulations
- Safe with patency check, tilt enable, timing bolus and simultaneous injection features
- Automatic operations (filling, priming)
- Scanner interface to CAN Open Class 4\*
- OptiBolus bolus shaping software
- Connectivity with Contrast&Care (optional)

*Components and consumables certified by the manufacturer*      \* dependent on type of scanner manufacturer



### Guerbet · OptiStar Elite

Application	Pressure	FlowRate
MR	10.3/ 13.8 bar*	0.1 – 10 ml/s / 0.1 – 8 ml/s*

**Highlights**  
 MR contrast delivery system

- Compatible with pre-filled syringes & vials
- Battery free & 3T certified
- One click loading
- Auto-retract rams
- Powerhead keys
- Console enable
- Patency check
- Timing bolus
- Drip mode
- Colour touchscreen
- Automatic pressure control
- Connectivity with Contrast&Care (optional)

*Components and consumables certified by the manufacturer*      \* dependent on type of syringe



### Guerbet · Illumena Néo

Application	Pressure	FlowRate
CT / Angio / Cardio	5.2 – 82.7 bar <sup>1</sup> / 5.2 – 21 bar <sup>2</sup>	0.1 – 40 ml/s <sup>1</sup> / 0.1 – 10 ml/s <sup>2</sup>

**Highlights**  
 Multi-mode contrast delivery system

- High visibility screen
- One finger operation fill bar
- Single or multi-injection procedures
- Switch between operating modes
- Hand switch and foot switches available
- Air Detection Aid & Warning System (ADAWS) identifies blood, empty syringes and air bolus
- Configurations:
  - Pedestal, ceiling or table mount
- Heater: 37° ± 3°
- Connectivity with Contrast&Care (optional)

*Components and consumables certified by the manufacturer*      <sup>1</sup>Angio mode / <sup>2</sup>CT mode





# THE INTERCONNECTED SOLUTIONS

## Injectors

### Medtron · Accutron CT-D Vision

Application	Pressure	FlowRate
CT	21 bar	0.1 – 10 ml/s

#### Highlights

- New design for more comfort with improved readability and less eye fatigue, new battery management system and new casters
- Enriched user experience with a simpler workflow and better patient care
- Integrated with RIS and PACS (as an option) as well as with the scanner interface to reduce workload for the operator and improve patient turnaround times
- Limits patient risk by reducing the amount of contrast a patient receives during injection
- Supports the development of contrast-enhanced mammography, a new clinical service in mammography; leading to potentially increased revenue



### Medtron · Accutron CT

Application	Pressure	FlowRate
CT	21 bar	0.1 – 10 ml/s

#### Highlights

- Whether you are budget conscious or newly exploring the potential use of a powered injector in your CT department, Accutron CT is your starting point
- Provides real-time pressure monitoring which allows for improved precision and safety
- Agile mobility with a configuration that provides flexibility to quickly change examination rooms
- Consistent reliability helps to reduce repeat examinations due to contrast mistiming



### Medtron · Accutron MR3

Application	Pressure	FlowRate
MR	21 bar	0.1 – 10 ml/s <sup>1</sup> / 000.1 – 30 ml/s <sup>2</sup>

#### Highlights

- The integrated infusion pump enables simultaneous administration of fluids during an MRI examination
- Works with select pre-filled syringes to increase throughput via quick use and improved patient turnaround times
- Integrated infusion pump enables simultaneous administration of additional medication needed by some patients to undergo MRI examination

<sup>1</sup> CM/NaCl / <sup>2</sup> Infusion pump

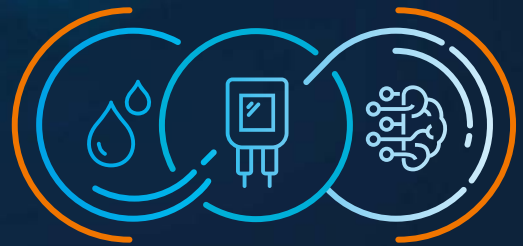

# UNIK

Tailored interconnected solutions driving your journey to excellence

**Guerbet Diagnostic Imaging** has designed a portfolio of **interconnected contrast imaging solutions** to enhance your decision-making at each point of the patient journey from diagnosis, to treatment, to follow-up, so you can focus on what matters most, efficiently improving patient outcomes. This is UNIK.

**For more information, please visit**  
[www.guerbet.com/products-solutions/](http://www.guerbet.com/products-solutions/)

**Guerbet** |

# Injectors

## Injectors

### Medtron · Accutron MR

Application	Pressure	FlowRate
MR	21 bar	0.1 – 10 ml

#### Highlights

- Keep Vein Open (KVO) software feature helps to maintain vascular access during longer imaging procedures
- Compatibility with selected pre-filled syringes makes it easier to change and select the most suitable contrast medium for each patient
- Can be used with two touch screen remote controls so that one injector is shared between two MR examination rooms



### Medtron · Accutron HP-D

Application	Pressure	FlowRate
Angio	83 bar <sup>1</sup> / 21 bar <sup>2</sup>	0.1 – 30 ml/s <sup>1</sup> / 0.1 – 10 ml/s <sup>2</sup>

#### Highlights

- Reduces beam hardening artifacts through flexible adjustment of contrast concentration using saline.
- Cleanly defined & reproducible contrast media bolus can be achieved by pushing contrast media with a saline bolus
- Wireless and mobile configuration with flexibility to quickly change exam rooms and eliminates power requirements
- May reduce the amount of contrast required per patient resulting in less operating expenses

<sup>1</sup>Angio mode / <sup>2</sup>CT mode



### Medtron · Accutron HP

Application	Pressure	FlowRate
Angio	83 bar <sup>1</sup> / 21 bar <sup>2</sup>	0.1 – 30 ml/s <sup>1</sup> / 0.1 – 10 ml/s <sup>2</sup>

#### Highlights

- Enables interdisciplinary clinical imaging examinations in both angiography and computed tomography
- Wireless and mobile configuration provides flexibility to quickly change examination rooms and eliminates barriers; such as nearby power requirements and/or cable installation
  - Reduces risk of infections by being easy to clean and hygienic
  - Integration with the scanner interface reduces workload for the operator and improves patient turnaround times

<sup>1</sup>Angio mode / <sup>2</sup>CT mode



## Dose Management Systems

### Guerbet · Contrast & Care



#### Highlights

Contrast&Care is a solution dedicated to contrast dose management. It connects to all Guerbet injectors and Hospital Information Systems (RIS, PACS, EMR... ) and collects all relevant data about contrast media usage, patient history, and injector activity. Contrast&Care facilitates the traceability of contrast media and provides several tools that help imaging centers optimize contrast media consumption.

### Guerbet · Dose & Care

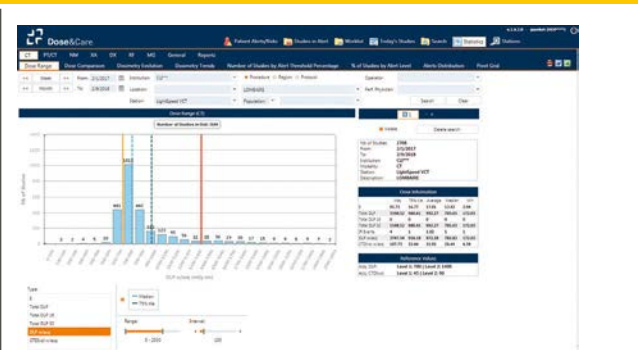

#### Highlights

Dose&Care is a state-of-the-art radiation dose monitoring solution, which allows documenting patient exams, understanding the reasons for excessive exposure and monitoring activities related to patient exposure. It provides the means to remain compliant with an ever-evolving regulation while improving the workflow and ensuring patient safety.

## Accessories / Complementary Systems

### Transatlantic · Transaflow Multi-Patient-Syringe-System 12/24h

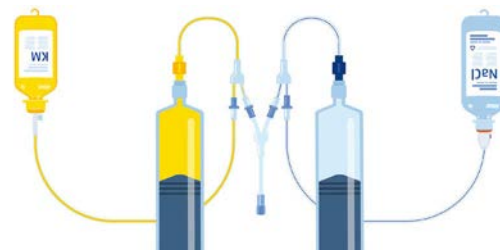

#### Highlights

Make your syringe injector safe for 12h or 24h multi-patient use, regardless of injector manufacturer. Transatlantic has been manufacturing and distributing multi-patient transfer systems for contrast media applications for over 10 years. The products are suitable for CT and MRI and a transfer system can be used on all common piston injectors. This makes ordering processes simpler and stock-keeping clearer and less expensive. The user works with one product and the routine is standardized. No more sticky bottoms or stuck systems! Our drip stop in our Multi-APS transfer systems also offers this special advantage. Transatlantic - your reliable partner for transfer systems. Quality Made in Germany.

Accessories / Complementary Systems

Transatlantic · Transaflow Multi-APS safety and PWL/PWLS 12h



**Highlights**

Quality 'Made in Germany': The safety filling systems Transaflow Multi-APS Safety in combination with the patient lines with integrated germ barrier Transaflow PWL or PWLS are suitable for all common CT and MRI syringe injectors. They offer all the advantages of a closed system: they are leak-proof, do not drip and do not stick. Several check valves and a self-sealing, disinfectable safety valve provide the best possible hygienic safety for patients and users. Multi-APS-Safety-systems and PWL/PWLS are produced in Germany and are available in many variants (Mini spike, insertion spike with drip chamber, for scanbag, filled flasks etc.). They are approved for up to twelve hours of use.

Transatlantic · Transaflow Multi-APS safety and PWL/PWLS 24h



**Highlights**

24h application duration with quality 'Made in Germany': The Transaflow Multi-APS Safety filling systems are suitable for all common CT and MRI syringe injectors in conjunction with the Transaflow PWL or PWLS patient lines with integrated germ barrier. They offer all the advantages of a closed system: they are leak-proof, do not drip and do not stick. Several high-quality check valves and a self-sealing, disinfectable safety valve provide the best possible hygienic safety for patients and users. Multi-APS Safety Systems and PWL/PWLS are produced in Germany and are available in many variants (mini spike, puncture spike with drip chamber, for scanbag, pre-filled flasks, etc.). They are approved for up to 24 hours of use.

# ACCUTRON<sup>®</sup> CT-D VISION. SIMPLY MORE.

The diagnostics specialist that can do more. More comfort, more mobility, more operating safety. More integration through Injection Data Sharing with RIS/PACS connection. View now at [medtron.com](http://medtron.com)



Hauptstrasse 255 · 66128 Saarbruecken  
[www.medtron.com](http://www.medtron.com)



# Interventional Systems

Multi-Modality Suites  
Bi-Plane  
Single Plane  
Surgical Flat Panel C-Arms  
Surgical II-C-Arms  
Accessories /  
Complementary Systems

**Canon**  
CANON ELECTRON TUBES & DEVICES CO., LTD.

**Canon**

**Swissray**

**FUJIFILM**

**GCTechnology GmbH**



**Medtronic**  
Further. Together

**SHIMADZU**  
Excellence in Science

**SIEMENS**  
Healthineers

**STEPHANIX**  
MEDICAL IMAGING SOLUTIONS

**STERNMED**  
we make it possible

**TX** TECHNIX



**ziehm imaging**

Multi-Modality Suites

**Canon · Alphenix 4D CT**

<b>Power</b> 100 kW	<b>Detector</b> a-Si / Csl	<b>Pixel size</b> 194 μm
------------------------	-------------------------------	-----------------------------



**Highlights**  
This integrated system combines premium CT and ceiling-mounted angiography technology. The perfect diagnostic and treatment set-up for high-risk procedures in various interventional segments such as:

- Interventional Oncology
- Trauma / Neuro / Stroke
- General Vascular
- Additional or Backup CT

The system is available with two different CT configurations: Aquilion One Genesis and Aquilion Prime

**Siemens Healthineers · Nexaris Angio-CT**

<b>Power</b> 100 kW	<b>Detector</b> a-Si / Csl	<b>Pixel size</b> 160 μm
------------------------	-------------------------------	-----------------------------



**Highlights**

- Hybrid suite with a common coordinate system that fuses images instantly
- Direct access to angiography and CT with Quick Switching
- Efficient multi-room configurations to share imaging equipment
- Enabling combined CT and angiography guidance in one session

**Siemens Healthineers · Nexaris Angio-MR-CT**

<b>Power</b> —	<b>Detector</b> —	<b>Pixel size</b> —
-------------------	----------------------	------------------------



**Highlights**

- Seamless access to multi-modality imaging
- Patient transfer without repositioning for barrier-free intraoperative imaging with Nexaris Dockable Table
- More possibilities during treatment with synergized Angio, MR, and CT image information

**Canon · Alphenix Biplane**

<b>Power</b> 100 kW	<b>Detector</b> a-Si / Csl	<b>Pixel size</b> 194 μm
------------------------	-------------------------------	-----------------------------



**Highlights**  
Cardio intervention demands speed, precision, and optimum performance. The Alphenix Biplane is designed to take advantage of the latest technological innovations to reduce dose for patients and staff. A revolutionary graphic user interface and multi-tasking computer enable the system to fully meet your requirement for high image quality, safety, ease of use, efficiency and improved workflow.

- Detector size: 20 × 20 cm

**Canon · Alphenix Biplane High Definition Detector**

<b>Power</b> 100 kW	<b>Detector</b> CMOS /a-Si / Csl	<b>Pixel size</b> 76 / 194 μm
------------------------	-------------------------------------	----------------------------------



**Highlights**  
The Alphenix Biplane is designed to take advantage of the latest technological innovations to reduce dose for patients and staff. A revolutionary graphic user interface and multi-tasking computer enable the system to fully meet your requirement for high image quality, safety, ease of use, efficiency and improved workflow. In addition to helping clinicians perform their neuro, peripheral, and cardiac endovascular therapy, Canon Medical's 30 × 30 cm True Hi-Definition Detector is now available for general interventional radiology.

- Detector size: 30 × 30 cm / 30 × 40 cm

**Canon · Alphenix Dual Plane**

<b>Power</b> 100 kW	<b>Detector</b> a-Si / Csl	<b>Pixel size</b> 194 μm
------------------------	-------------------------------	-----------------------------



**Highlights**

- A single room X-ray solution with two C-Arms both with dedicated imaging chains for interventional cardiac and angiography procedures that share a common generator, table, monitors and digital acquisition system.
- Designed for both diagnostic and interventional examinations.
- Space, time and dose saving technology are key design elements of the Alphenix Dual Plane.
- Detector size: 20 × 20 cm / 30 × 40 cm

## Bi-Plane

### Shimadzu · Trinias B12 / B8 Unity Edition

<b>Power</b> 2 × 100 kW	<b>Detector</b> a-Si / Csl	<b>Pixel size</b> 194 μm
----------------------------	-------------------------------	-----------------------------



#### Highlights

- Detector size: 12 × 12" (30 × 30 cm) / 8 × 8" (20 × 20 cm)
- Wide coverage for smooth operability
- SCORE Pro Advance image processing technology
- Unique pioneering imaging technology: motion-tolerant SCORE RSM
- SCORE CT
- SCORE 3D
- SCORE Navi / Navi+Plus
- SMART design concept
- Comprehensive dose management package

### Siemens Healthineers · Artis zee, Artis Q, Artis Q.zen

<b>Power</b> 100 kW	<b>Detector</b> a-Si / Csl	<b>Pixel size</b> 184 μm
------------------------	-------------------------------	-----------------------------

#### Highlights

Biplane system for interventional imaging. The Artis biplane system offers high performance in interventional imaging combined with high positioning flexibility.

- Left-side biplane imaging position for free head access
- Single plane operation with extended position flexibility enabled by rotated table
- Ergonomic system controls for smooth table-side operation
- 3D acquisition rate up to 75 f/s



### Siemens Healthineers · Artis icono biplane

<b>Power</b> 100 kW	<b>Detector</b> a-Si / Csl	<b>Pixel size</b> 184 μm
------------------------	-------------------------------	-----------------------------



#### Highlights

ARTIS icono biplane offers great technologies for interventional neuroradiology.

- New cone-beam CT trajectory *syngo* DynaCT Sine Spin reduces artifacts for excellent soft-tissue resolution
- *syngo* DynaCT Multiphase integrates collateral vessel imaging in the angio suite
- Twin Spin enables seamless switching between 2D and 3D thanks to mechanical improvements
- New image chain OPTIQ enables constant image quality using a contrast-driven technique (CNR\*) based on automatic parametrization and intelligent, self-adjusting algorithms

\*Contrast-to-noise ratio

# RADBOOK 2022

Please visit us at

[healthcare-in-europe.com](http://healthcare-in-europe.com)

## Single Plane

### Canon · Alphenix Core+

<b>Power</b> 100 kW	<b>Detector</b> a-Si / Csl	<b>Pixel size</b> 194 μm
------------------------	-------------------------------	-----------------------------



#### Highlights

Cardio intervention demands speed, precision, and optimum performance. The flexible Alphenix Core+ is designed to take advantage of the latest technological innovations to reduce dose for patients and staff.

A revolutionary graphic user interface and multi-tasking computer enable the system to fully meet your requirement for high image quality, safety, ease of use, advanced efficiency and improved workflow.

- Detector size: 20 × 20 cm

### Canon · Alphenix Core+ High Definition Detector

<b>Power</b> 100 kW	<b>Detector</b> CMOS / a-Si / Csl	<b>Pixel size</b> 76 / 194 μm
------------------------	--------------------------------------	----------------------------------



#### Highlights

The flexible Alphenix Core+ is designed to take advantage of the latest technological innovations to reduce dose for patients and staff. A revolutionary graphic user interface and multi-tasking computer enable the system to fully meet your requirement for high image quality, safety, ease of use, high efficiency and improved workflow. In addition to helping clinicians perform their neuro, peripheral, and cardiac endovascular therapy, Canon Medical's 30 × 30 cm True Hi-Definition Detector is now available for general interventional radiology.

- Detector size: 30 × 30 cm / 30 × 40 cm

Single Plane

**Canon · Alphenix Sky**

<b>Power</b> 100 kW	<b>Detector</b> a-Si / Csl	<b>Pixel size</b> 194 µm
------------------------	-------------------------------	-----------------------------



**Highlights**  
Vascular intervention demands speed, precision, and optimum performance. The Alphenix Sky is designed to take advantage of the latest technological innovations to reduce dose for patients and staff. A revolutionary graphic user interface and multi-tasking computer enable the system to fully meet your requirement for high image quality, safety, ease of use, high efficiency and improved workflow.

- Detector size: 20 × 20 cm

**Canon · Alphenix Sky**

<b>Power</b> 100 kW	<b>Detector</b> a-Si / Csl	<b>Pixel size</b> 194 µm
------------------------	-------------------------------	-----------------------------



**Highlights**  
Vascular intervention demands speed, precision, and optimum performance. The Alphenix Sky is designed to take advantage of the latest technological innovations to reduce dose for patients and staff. A revolutionary graphic user interface and multi-tasking computer enable the system to fully meet your requirement for high image quality, safety, ease of use, high efficiency and improved workflow.

- Detector size: 30 × 30 cm / 30 × 40 cm

**Canon · Alphenix Sky+**

<b>Power</b> 100 kW	<b>Detector</b> a-Si / Csl	<b>Pixel size</b> 194 µm
------------------------	-------------------------------	-----------------------------

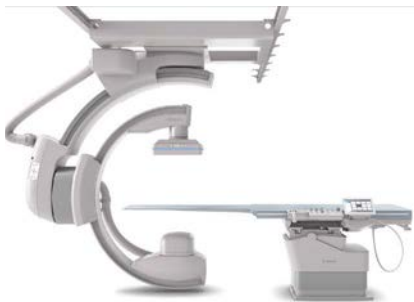

**Highlights**  
Nowadays 3D plays a key role in high risk procedures such as aneurysm coiling, AVM / Fistula embolization, endovascular Aortic Aneurysm Repair, etc. As its new flagship, the Alphenix Sky+ incorporates state-of-the-art technologies allowing whole 3D body coverage at 80°/sec covering a range of 210°, from head to toe without any patient or table movement and free head access.

- Detector size: 30 × 40 cm

**Canon · Alphenix Sky+ High Definition Detector**

<b>Power</b> 100 kW	<b>Detector</b> CMOS / a-Si / Csl	<b>Pixel size</b> 76 / 194 µm
------------------------	--------------------------------------	----------------------------------



**Highlights**  
Nowadays 3D plays a key role in high risk procedures such as aneurysm coiling, AVM / Fistula embolization, endovascular aortic aneurysm repair, etc. The Alphenix Sky+ incorporates state-of-the-art technologies allowing 3D body coverage at 80°/sec covering a range of 210°, from head to toe without any patient or table movement and free head access. Helping clinicians perform their neuro, peripheral, and cardiac endovascular therapy, Canon Medical's 30 × 40 cm True Hi-Definition Detector is now available for general interventional radiology.

- Detector size: 30 × 40 cm

**Canon · Alphenix Hybrid**

<b>Power</b> 100 kW	<b>Detector</b> a-Si / Csl	<b>Pixel size</b> 194 µm
------------------------	-------------------------------	-----------------------------



**Highlights**  
The combination of the Alphenix ceiling mounted C-Arm with a fully integrated dedicated surgical table, e.g. Maquet Magnus or Trumpf Trusystem 7500, perfectly meets the requirements for the rapidly growing number of hybrid procedures. Its flexibly designed ceiling rail system allows perfect patient access in any situation.

- Detector size: 30 × 40 cm / 30 × 30 cm / 20 × 20 cm

**Canon · Alphenix Hybrid+**

<b>Power</b> 100 kW	<b>Detector</b> a-Si / Csl	<b>Pixel size</b> 194 µm
------------------------	-------------------------------	-----------------------------



**Highlights**  
The combination of the Alphenix ceiling mounted C-Arm with a fully integrated dedicated surgical table, e.g. Maquet Magnus or Trumpf Trusystem 7500, perfectly meets the requirements for the rapidly growing number of hybrid procedures. With its unique double sliding C-Arm the Alphenix Hybrid+ provides ultrafast whole body 3D coverage, free head access and a unique lateral C-Arm stroke for better ergonomics, improved productivity and stunning 3D images from head to toe.

- Detector size: 30 × 40 cm

## Single Plane

### Canon · Alphenix Core

<b>Power</b> 100 kW	<b>Detector</b> a-Si / Csl	<b>Pixel size</b> 194 µm
------------------------	-------------------------------	-----------------------------



**Highlights**  
Cardiovascular intervention demands speed, precision, and optimum performance. The compact Alphenix Core is designed to take advantage of the latest technological innovations to reduce dose for patients and staff. A revolutionary graphic user interface and multi-tasking computer enable the system to fully meet your requirement for high image quality, safety, ease of use, advanced efficiency and improved workflow.

- Detector size: 20 × 20 cm / 30 × 30 cm

### Shimadzu · Trinias C16 / C12 / C8 Unity Edition

<b>Power</b> 100 kW	<b>Detector</b> a-Si / Csl	<b>Pixel size</b> 194 µm
------------------------	-------------------------------	-----------------------------



**Highlights**

- Detector size:
  - 16 × 12" (40 × 30 cm)
  - 12 × 12" (30 × 30 cm)
  - 8 × 8" (20 × 20 cm)
- Wide coverage for smooth operability
- SCORE Pro Advance image processing technology
- Comprehensive dose management technology
- Flex-APS
- SCORE RSM – motion-tolerant DSA
- SCORE StentView
- SCORE Chase
- SCORE CT / 3D / Navi
- SMART Table with advanced tilting functions
- SMART Design concept

### Shimadzu · Trinias C12 Unity Hybrid Edition

<b>Power</b> 100 kW	<b>Detector</b> a-Si / Csl	<b>Pixel size</b> 194 µm
------------------------	-------------------------------	-----------------------------



**Highlights**

- Detector size: 12 × 12" (30 × 30 cm)
- High sensitive detector technology for outstanding image quality
- SCORE Pro Advance: real-time image enhancement processing technology
- High-speed C-Arm to perform 3D examinations
- Interdisciplinary applications: SCORE RSM, SCORE 3D, SCORE CT, SCORE Navi+Plus, Flex-APS
- High flexible OR table provides an optimum radiographic area featuring a whole-body coverage

### Shimadzu · Trinias F12 / F8 Unity Edition

<b>Power</b> 100 kW	<b>Detector</b> a-Si / Csl	<b>Pixel size</b> 194 µm
------------------------	-------------------------------	-----------------------------



**Highlights**

- Detector size:
  - 12 × 12" (30 × 30 cm) / 8 × 8" (20 × 20 cm)
- Wide coverage for smooth operability
- SCORE Pro Advance image processing technology
- Comprehensive dose management technology
- Flex-APS
- SCORE RSM – motion-tolerant DSA
- SCORE StentView
- SCORE Chase
- SCORE CT / 3D / Navi
- SMART Table with advanced tilting functions
- SMART Design concept

### Siemens Healthineers · Artis pheno

<b>Power</b> 100 kW	<b>Detector</b> a-Si / Csl	<b>Pixel size</b> 160 µm
------------------------	-------------------------------	-----------------------------



**Highlights**  
ARTIS pheno – the only robotic C-arm system on the market - delivers images for preprocedural planning, intraoperative guidance, and immediate assessment

- Detector: zen40HDR, hi-res crystalline silicon / Csl, 30 × 40 (2,496 × 1,856 px), 160 µm
- Simplify and standardize surgical procedures – with Procedural Intelligence
- Visualization of up to ten vertebrae simultaneously – with large-volume 3D scanning
- Easy cleaning and disinfection – thanks to a seamless exterior with smooth surface and antimicrobial paint with significant effects on non-sporulating microorganisms
- Wide-space C-arm – with a clearance of 95.5 cm

### Siemens Healthineers · Artis zee, Artis Q, Artis Q.zen

<b>Power</b> 100 kW	<b>Detector</b> a-Si / Csl	<b>Pixel size</b> 154 / 160 / 184 µm
------------------------	-------------------------------	---



**Highlights**  
The Artis ceiling-mounted system enables clinicians to care with ease, precision and flexibility.

- Detector:
  - 20 × 20 (1,024 × 1,024 px), 184 µm
  - 30 × 40 (1,920 × 2,480 px), 154 µm
  - 30 × 40 (1,920 × 2,480 px), 154 µm
- Positioning flexibility that supports any angle
- Ergonomic system controls for smooth table-side operation
- 3D acquisition rate up to 75 f / s
- Complete 3D-portfolio including cross-sectional imaging with syngo DynaCT and syngo 3D Roadmap



Single Plane

Siemens Healthineers · Artis zee, Artis Q, Artis Q.zen		
Power	Detector	Pixel size
100 kW	a-Si / CsI	184 µm

**Highlights**  
 The Artis floor-mounted system enables clinicians to care with ease, precision and flexibility for small rooms.

- Small footprint of 29 qm
- Slim-line design for easy patient access
- Ergonomic system controls for smooth table-side operation
- 3D acquisition rate up to 75 f/s
- Complete 3D-portfolio including cross-sectional imaging with syngo DynaCT and syngo 3D Roadmap



Siemens Healthineers · Artis zee		
Power	Detector	Pixel size
100 kW	a-Si / CsI	154 µm

**Highlights**  
 Artis zee multi-purpose is designed to meet the demands of interventional radiology and fluoroscopy.

- Detector: 30 × 40 (1,920 × 2,480 pixels), 154 µm
- Ergonomic system controls for smooth table-side operation
- 2k imaging with highly practical and user-friendly handling features
- 3D acquisition rate up to 75 f/s

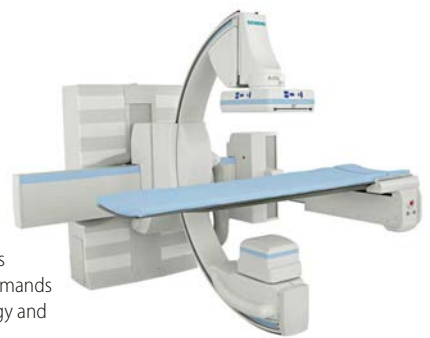

# MORE CLARITY



## in cardiovascular imaging

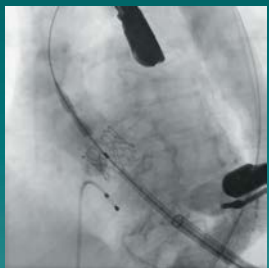

Due to an aging population, we are seeing a rising burden of cardiovascular diseases. Therefore we have developed sophisticated intraoperative imaging solutions that bring more clarity into cardiovascular interventions. Discover our innovative mobile C-arm solutions at [www.ziehm.com/clarity](http://www.ziehm.com/clarity).



## Single Plane

### Siemens Healthineers · Artis one

<b>Power</b> 100 kW	<b>Detector</b> a-Si/CsI	<b>Pixel size</b> 184 µm
------------------------	-----------------------------	-----------------------------



**Highlights**  
Artis one delivers proven state-of-the-art technology. Intelligent operation is enhanced by a configurable heads up display, allowing easy system operation and undistracted operator attention.

- Detector: as30, (1,560 × 1,420 pixels)
- Small footprint of 25 qm<sup>2</sup>
- Slim-line design for easy patient access

- Ergonomic system controls for smooth table-side operation
- Ceiling-like flexibility and full patient coverage of 2.10 m
- Integrated 3D-Imaging and review with acquisition rate up to 66 f/s

### Siemens Healthineers · Artis icono floor

<b>Power</b> 100 kW	<b>Detector</b> a-Si	<b>Pixel size</b> 154 µm
------------------------	-------------------------	-----------------------------



**Highlights**  
ARTIS icono floor offers great technologies for interventional radiology

- Excellent longitudinal coverage of 2.10 m for imaging most patient from head to toe
- Lateral coverage of 1.90 m supporting new workflows and
- Motorized system movement without the need to move the table

- OPTIQ technique based on automatic parametrization and intelligent, self-adjusting algorithms.
- Case Flows to personalize and standardize workflows

### Technix · Quantic

<b>Power</b> 80 kW	<b>Detector type</b> a-Si/CsI	<b>Pixel size</b> 139 µm
-----------------------	----------------------------------	-----------------------------



**Highlights**

- Detector size: 43 × 43 cm
- Advanced DR fluoroscopic equipment design to satisfy a wide range of applications
- The fully motorized C-arm assures possibility to work with FPD above and below the combined table
- Synchronized movements between C-arm and patient table
- The strength of the system is achieved thanks to the integration of fluoroscopy and radiography in one system with a user-friendly interface

# KU

## GESUNDHEITSMANAGEMENT

Please visit us at

[ku-gesundheitsmanagement.de](http://ku-gesundheitsmanagement.de)

## Surgical Flat Panel C-Arms

### Fujifilm · FDX Visionary-C and CS

<b>Power</b> 5 – 20 kW	<b>Detector</b> CsI	<b>Pixel size</b> 154 – 205 µm
---------------------------	------------------------	-----------------------------------



**Highlights**

- Advanced C-arm Fluoroscopy solutions engineered for fast, precise positioning and advanced image quality
- FDX Visionary-CS's compact all-in one design and built in large 27" landscape monitor allows improved access in smaller rooms.
- FDX Visionary-C's perfectly balanced lightweight C-arm and dual 21.5" touchscreen monitor cart provides fast accurate positioning and ultra-sharp image viewing.

- 21 × 21 cm and 30 × 30 cm amorphous Silicon (aSi) flat panel detectors provide ultra-low dose fluoroscopy.
- Featuring a removable grid and dedicated 'radiography mode' for high quality still imaging

### GMM Group · Symbol FP – Mobile C-Arm System

<b>Power</b> 10 / 20 / 25 kW	<b>Detector</b> a-Si	<b>Pixel size</b> 145 – 179 µm
---------------------------------	-------------------------	-----------------------------------



**Highlights**

- Innovative portable C-Arm with high power generator, high speed rotating X-ray tube and flat panel detectors
- Compact design and reduced weight for a safe and easy patient approach
- Touchscreen display for a complete parameter management
- Advanced digital imaging software and dose reduction
- Wide range of applications, including vascular surgery with DSA&RM tool
- Medical grade monitors on workstation cart
- Detector Size: 23 × 23 cm – 30 × 30 cm

**Surgical Flat Panel C-Arms**

**Intermedical · “New” Radius XP with flat panel**

<b>Power</b> 30 kW	<b>Detector</b> a-Si / CsI	<b>Pixel size</b> ---
-----------------------	-------------------------------	--------------------------



**Highlights**

- Large power reserve of 30 kW
- Boost up to 250 mA
- Excellent 1,536 × 1,536 pixels image quality
- Max. 25 frames/sec
- Touch Screen Panel PC directly on C-Arm with live image preview
- E-motion: all C-Arm movements can be motorized
- New Dual Cooling System for Housing and Generator
- Dual Power System: power reserve system
- Wireless pedal as option
- Available with FPD 30 × 30 or 21 × 21 cm

**Medtronic · O-arm System**

<b>Power</b> 32 kW	<b>Detector</b> a-Si - 2.0K × 1.5K	<b>Pixel size</b> 194 μm
-----------------------	---------------------------------------	-----------------------------



**Highlights**

- Designed for surgery
- 13s true 360° 3D scan – Fully mobile
- Flexible intra-operative 2D- and 3D-imaging
- 3D scan volume up to 40 cm width
- Seamless integration in OR workflow
- Easy in use: All motions motorized, simple control panel
- Position memory remembers four scan positions
- Easy draping of the breakable gantry
- Seamless integrating with Stealth-Station Navigation
- New 2D long-film option allows AP and lateral imaging up to 45 cm length

**Siemens Healthineers · Cios Spin**

<b>Power</b> 12/ 25 kW	<b>Detector</b> 30 × 30 cm	<b>Pixel size</b> 152 μm
---------------------------	-------------------------------	-----------------------------



**Highlights**

- More certainty in demanding cases with intraoperative quality control based on dedicated 3D technology
- More efficiency in intraoperative 3D imaging
- More cost-effectiveness in surgery through intraoperative corrections based on 3D images

**Siemens Healthineers · Cios Alpha**

<b>Power</b> 12/ 25 kW	<b>Detector</b> 20 × 20/ 30 × 30 cm	<b>Pixel size</b> 152 μm
---------------------------	--	-----------------------------



**Highlights**

- Up to 25 percent more coverage<sup>1</sup> even during image rotation – thanks to smart collimation
- Retina technology enables surgeons to see the details they need to see
- Improve efficiency in your clinical workflow – with remote control unit<sup>2</sup>, electromagnetic brakes, and a wireless footswitch<sup>2</sup>

<sup>1</sup> Compared to conventional 33 cm image intensifiers <sup>2</sup> Option

**Siemens Healthineers · Cios Flow**

<b>Power</b> 2.3 kW	<b>Detector</b> 20 × 20/ 30 × 30 cm	<b>Pixel size</b> 152 μm
------------------------	--	-----------------------------



**Highlights**

- Intuitive use, low weight, and easy maneuverability – for easy system operation and more ease in the OR
- Boost system utilization – with a multipurpose system that can be used across a variety of disciplines
- Safeguard data and access – with advanced cyber security

**Siemens Healthineers · Cios Select with FD**

<b>Power</b> 2.3 kW	<b>Detector</b> 21 × 21 cm	<b>Pixel size</b> 205 μm
------------------------	-------------------------------	-----------------------------



**Highlights**

- Retina FD technology - See more anatomical details with flat-detector imaging
- Productivity – streamline your work with smart touch user interface, wireless footswitch<sup>1</sup>, and easy patient positioning
- Reliability – experience 99.8% system availability<sup>2</sup>

<sup>1</sup> Option <sup>2</sup> Average system availability over the entire Siemens C-Arm installed base

## Surgical Flat Panel C-Arms

### Stephanix · Omniscope DReam

Power	Detector	Pixel size
5 kW / 20 kW	21 × 21 cm / 30 × 30 cm	154 μm



#### Highlights

- Orthopaedic, head, spine, thorax, abdomen, vascular, cardiac
- Large C-Arm depth and wide orbital rotation
- Adjustable height & angle of medical displays
- Dynamic FPD with high DQE and MTF
- Removable grid
- Advanced functions : APR, post-processings, DSA
- DICOM connectivity
- Detector size: 21 × 21 cm / 30 × 30 cm

### Stephanix · Omniscope DReam S

Power	Detector	Pixel size
4.2 / 5 kW	21 × 21 cm / 30 × 30 cm	205 / 194 μm



#### Highlights

- Orthopaedic / Urology / Cerebral / Thoracic / Pain therapy / Peripheral vascular using DSA function
- Single unit system, all components integrated into the C-arm stand
- Very small footprint
- 4 Mpixel 27" medical monitor on an articulated arm, adjustable height and angle
- Dynamic FPD with high DQE and MTF
- Advanced functions : APR, post-processings, DSA
- DICOM connectivity
- Detector size: 21 × 21 cm / 30 × 30 cm

### SternMed · Xenox C400

Power	Detector	Pixel size
30 kW	a-Si	200 μm



#### Highlights

- State of the art Flat panel 21 × 21 cm or 30 × 30 cm
- Digital memories: 1.5k × 1.5k
- 30 kW H.V. generator
- Dual cooling systems for immediate and effective heat removal
- Dual power system: Power reserve system
- Fully motorized C-arm (optional)
- 215 mm horizontal run (175 mm in motorized version)
- Wide orbital movement 150°
- C-arm lateral rotation: ± 180°
- 10" touch screen control console

### Swissray · Smart C

Power	Detector type	Pixel size
Battery powered	CsI CMOS	99 μm



#### Highlights

- The world's first battery-powered, completely wireless, hyper-portable, Mini C-arm providing unparalleled digital fluoroscopic imaging capabilities.
- Battery-powered, lightweight Mini C-Arm
- Sophisticated Software provides exceptional real-time image quality
- CMOS Detector for low dose imaging
- Wireless tablet enables enhanced visualization
- Position the C-Arm on its front or side to quickly acquire images
- Compact design allows the use directly on the surgical table
- Modular system offers addition of supporting stand
- Robust and safe transportation case for out-clinic exams

### Technix · TCA7

Power	Detector	Pixel size
5 / 20 kW	21 × 21 cm / 30 × 30 cm	205 / 194 μm



#### Highlights

- Rotating anode, water cooled for long procedures
- Large C-Arm and wide orbital rotation for easy patient positioning
- Intuitive touchscreen user interface with image preview
- Removable grid and motorized filters for pediatric applications
- Up to 250.000 image storage capacity
- CD / DVD and USB for image exporting
- Full DICOM connectivity

### Ziehm · Vision RFD Hybrid Edition

Power	Detector	Pixel size
25 / 30 kW	CMOS / a-Si	100 μm / 194 μm



#### Highlights

- The Ziehm Vision RFD Hybrid Edition\* is a powerful 30\*\* kW mobile C-arm that is available with CMOS imaging technology to successfully perform during highly demanding interventional cardiovascular procedures. Benefit from Enhanced Vessel Visualization and bring color to your vascular X-ray images. With its zero room preparation, the comprehensive mobile solution easily takes your OR to the next level.
- Detector size: 31 × 31 cm / 20.5 × 20.5 cm (CMOS) · 30 × 30 cm (a-Si)

\* Ziehm Vision RFD Hybrid Edition represents a group of optional hardware and software that creates an option package on the device named Ziehm Vision RFD.  
 \*\* In combination with dedicated cardio packages

**Surgical Flat Panel C-Arms**

**Ziehm · Vision RFD 3D**

<b>Power</b> 25 / 30* kW	<b>Detector</b> CMOS / a-Si	<b>Pixel size</b> 100 µm / 194 µm
-----------------------------	--------------------------------	--------------------------------------



**Highlights**  
 Bundling 2D and 3D functionality for greater intraoperative control, the Ziehm Vision RFD 3D reduces the need for postoperative CT scans and costly corrective surgeries. It is equipped with Ziehm Iterative Reconstruction (ZIR) to minimize fan and metal artifacts in 3D reconstruction, so far only known from CT imaging. This makes the Ziehm Vision RFD 3D ideal for high-end orthopedic, trauma and spinal interventions as well as for demanding multidisciplinary use.

- Detector size: 31 × 31 cm (CMOS) · 30 × 30 cm (a-Si)

\* In combination with dedicated cardio packages

**Ziehm · Vision RFD**

<b>Power</b> 25 kW	<b>Detector</b> CMOS / a-Si	<b>Pixel size</b> 100 µm / 194 µm
-----------------------	--------------------------------	--------------------------------------



**Highlights**  
 The Ziehm Vision RFD is equipped with a powerful generator that penetrates even large anatomy. In addition, advanced active cooling facilitates long and demanding procedures and the intuitive Ziehm usability concept\* helps surgeons ensure consistently high clinical standards. This impressive feature lineup make the systems ideal for challenging interventions.

- Detector size: 31 × 31 cm / 20.5 × 20.5 cm (CMOS) · 30 × 30 cm (a-Si)

\* The Usability Concept includes a variety of hard- and software features. Due to regulatory reasons the availability of each feature may vary. Please contact your local Ziehm Imaging sales representative for detailed information.

**Ziehm · Vision FD**

<b>Power</b> 2.4 kW	<b>Detector</b> CMOS / a-Si	<b>Pixel size</b> 100 µm / 150 µm
------------------------	--------------------------------	--------------------------------------



**Highlights**  
 Now in the upgraded CMOS-line\*, the Ziehm Vision FD features an enhanced imaging chain for excellent image quality and – thanks to the Advanced Active Cooling – is designed for continuous use. In addition, finely tuned workflows and new software features help to optimize patient outcomes and further increase productivity. The Ziehm Vision FD is now also available with a 31 × 31 cm / a-Si flat-panel. The bigger detector size allows to cover larger anatomical regions in orthopedic and vascular surgery.

- Detector size: 20.5 × 20.5 cm (CMOS) · 31 × 31 cm (a-Si)

\* CMOSline represents a system configuration that is based on a Ziehm Imaging CMOS flat-panel detector.

**Ziehm · Solo FD**

<b>Power</b> 2.4 kW	<b>Detector</b> CMOS	<b>Pixel size</b> 100 µm
------------------------	-------------------------	-----------------------------



**Highlights**  
 With its all-in-one design, the Ziehm Solo FD is one of the most compact C-arms on the market for even the smallest treatment scenarios. The system is equipped with the latest CMOS flat-panel technology – to perform a wide range of applications like orthopedics, trauma and pain management with excellent image quality. Versatile viewing options offer maximum flexibility in the OR to support your clinical workflow.

- Detector size: 20.5 × 20.5 cm

**Surgical II-C-Arms**

**GMM Group · Symbol – Mobile C-Arm System**

<b>Power</b> 4 / 5 / 10 kW	<b>II format</b> 9" / 12"	<b>CCD-matrix</b> 1k × 1k
-------------------------------	------------------------------	------------------------------



**Highlights**

- Mobile C-Arm system with high frequency monobloc generator and 9" / 12" high contrast image intensifier
- Light-weight C-Arm for wide and precise movements
- Intuitive interface for easy parameter control
- Advanced digital image processing software
- Optimal image quality with low dose levels
- Various applications, including vascular surgery with DSA & RM tool
- Medical grade monitors on workstation cart

**Intermedical · "New" Radius**

<b>Power</b> 3,5 / 5 kW	<b>II format</b> 9"	<b>CCD-matrix</b> 1k × 1k
----------------------------	------------------------	------------------------------



**Highlights**

- High resolution camera for fixed or rotating anode
- Touchscreen user interface
- High configuration cart with two 19" medical monitors
- Remote control
- Up to 110.000 image storage capacity (expandable on request)
- Laser for patient centering
- CD / DVD and USB for image exporting
- Full DICOM connectivity

## Surgical II-C-Arms

### Intermedical · Radius Single

<b>Power</b> 3,5/5 kW	<b>II format</b> 9"	<b>CCD-matrix</b> 1k x 1k
--------------------------	------------------------	------------------------------



**Highlights**

- Small and practical C-arm with one orientable 24" LCD touchscreen monitor, assembled directly on the unit (no trolley)
- Membrane keyboard with alphanumeric touchscreen LCD display for all the parameters and error messages; it can be rotated  $\pm 60^\circ$
- Software with 55.000 images (expandable on request)
- Measure software included in the standard configuration
- DICOM packages available on request

### Shimadzu · Opescope Acteno

<b>Power</b> 2 kW	<b>II format</b> 23 / 15 cm	<b>CCD-matrix</b> 1 x 1 k
----------------------	--------------------------------	------------------------------



**Highlights**

- High quality imaging
- Easy operation through fully balanced C-Arm
- Memory functions support an efficient workflow
- Magnetic locks and all-free buttons
- Inside C-Arm cabling
- Flexible upgradeability

### Siemens Healthineers · Cios Select

<b>Power</b> 2,5 kW	<b>II format</b> 23 cm	<b>CCD-matrix</b> 1 k <sup>2</sup>
------------------------	---------------------------	---------------------------------------



**Highlights**

- 99.8 percent system availability<sup>1</sup> – reliability in a smart, lean design
- Smart system operation – with an intuitive user interface
- High image quality – combined with IDEAL (Intelligent Dose Efficiency Algorithm) dose management

<sup>1</sup>Average system availability over the entire Siemens C-Arm installed base

### Villa Sistemi Medicali · Arcovis 3000 S Compact

<b>Power</b> 3,5 kW	<b>II format</b> 9"	<b>CCD-matrix</b> 0,5 x 0,5 k
------------------------	------------------------	----------------------------------



**Highlights**

- Compact C-Arm unit available with 9" I.I. and stationary anode tube
- Equipped with an on-board 17" LCD monitor, not requiring external displays on trolley
- Last Image Hold and storage system based on non-volatile technology
- $\pm 60^\circ$  rotating control panel for immediate operation even in the most difficult environment

### Villa Sistemi Medicali · Arcovis 3000 S/R

<b>Power</b> 3,5 – 15 kW	<b>II format</b> 9" / 12"	<b>CCD-matrix</b> 0,5 x 0,5 k / 1 x 1 k
-----------------------------	------------------------------	--



**Highlights**

- Application in urology, cardiology, orthopedics and general surgery
- Choice between fixed anode (3000 S) or rotating anode (3000 R) versions
- Choice between either 9" I.I. (with stationary or rotating anode) or 12" I.I. (with rotating anode)
- Choice of 0,5 x 0,5 k or 1 x 1 k camera and several image storage options to satisfy all applications
- Premium version with 15 kW power, 9" or 12" I.I., 1 x 1 k camera

### Ziehm · Vision R

<b>Power</b> 20 kW	<b>II format</b> 23 cm / 31 cm	<b>CCD-matrix</b> 1 k x 1 k
-----------------------	-----------------------------------	--------------------------------



**Highlights**

Equipped with a powerful monoblock generator with rotating anode technology, the Ziehm Vision R combines excellent image quality with minimized dose levels. The outstanding power reserves make this C-arm particularly suited for demanding procedures in cardiovascular surgery and interventional cardiology, including AAA, PTCA and coronary angioplasty.

**Surgical II-C-Arms**

**Ziehm · Vision**

<b>Power</b> 2.02 kW	<b>II format</b> 23 cm	<b>CCD-matrix</b> 1 k×1 k
-------------------------	---------------------------	------------------------------



**Highlights**  
As the basic technology platform for all mobile imaging systems in the Ziehm Vision family, this C-arm suits the broadest spectrum of surgical applications. Thanks to its liquid cooling system, the Ziehm Vision is designed for continuous use even during longer procedures. Packed with leading-edge functionality, the Ziehm Vision sets a standard in mobile imaging and ensures minimized dose levels.

**Ziehm · Solo**

<b>Power</b> 2.02 kW	<b>II format</b> 23 cm	<b>CCD-matrix</b> 1 k×1 k
-------------------------	---------------------------	------------------------------



**Highlights**  
Thanks to the integrated monitor, this C-arm is one of the most compact and versatile on the market. The Ziehm Solo is especially designed for crowded treatment scenarios in pain management, orthopedics and other applications. As an option, the Ziehm Solo can be easily supplemented with a Ziehm viewing station and ceiling or wall-mounted monitors. It is also available as a portable option for field operations.



Please visit us at  
**med-eng.de**

**Accessories / Complementary Systems**

**Canon Electron Tubes & Devices · X-ray Image Intensifier**



**Highlights**

- Suitable for mobile C-Arms
- Smart design with smooth surfaces
- Excellent performance and high reliability
- Advanced simulation technologies used in development and production
- Our unique technologies provide a high Gx value, reducing radiation exposure to the patient.
- Environmentally friendly
- Compliant with the RoHS directive
- Free from hazardous substances such as hexavalent chromium and cadmium
- Detector: Xray Image Intensifier
- Size: Field size 9 inch, 9/6/4.5 inch
- Output image size Ø 20mm , Ø25mm
- Design: For C-Arm

**Canon Electron Tubes & Devices · LM-Angio Tube**

<b>Power</b> 100 kW	<b>Capacity</b> 2.1 MHU (Anode Heat Capacity)
------------------------	--



**Highlights**

- For angiography systems (2.1 MHU)
- Uses a liquid metal bearing
- Our unique liquid metal bearing technology
- Compact Housing – provides a long tube life, quiet operation, high stability, and excellent reliability.

**Canon Electron Tubes & Devices · Angio Tube Assembly**

<b>Power</b> 100 kW	<b>Capacity</b> 3 MHU (Anode Heat Capacity)
------------------------	--



**Highlights**

- For angiography systems (3 MHU)
- Uses a liquid metal bearing
- Our unique liquid metal bearing technology
- Compact Housing – provides a long tube life, quiet operation, high stability, and excellent reliability.

## Accessories / Complementary Systems

### GCTechnology · CIRS Phantoms



Multimodality lumbar training phantom

#### Highlights

- Multi modality abdominal biopsy phantom (for CT, US, MRI)
- Biopsy breast phantom
- Thyroid training phantom
- Prostate training phantoms family
- Kidney training phantom
- Vascular access training phantom

### I.A.E. · C30-RTM 70

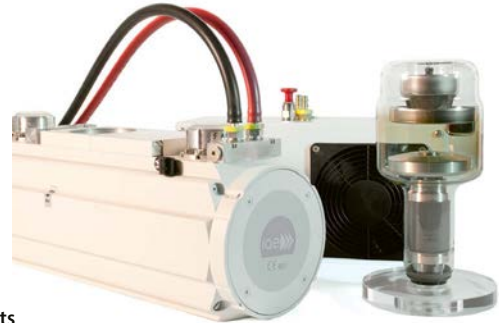

#### Highlights

- Rotating anode X-Ray tube unit designed for mobile c-arm equipment
- Lead lined single piece aluminium body, internal pump for oil circulation, to improve thermal exchange
- Choice of HT cable socket: Parker or Claymount mini
- Optional remote water-air heat exchanger increases heat dissipation to 500W continuous for demanding interventional applications
- Water cooling can be mounted or upgraded on field

### Siemens Healthineers · Corindus CorPath GRX



#### Highlights

- The first robotic platform designed for interventional physicians
- Enables precise measurement of anatomy and device positioning
- Added benefit of radiation protection for the physician and the potential to reduce radiation exposure for staff and patients
- technIQ Smart Procedural Automation provides predictable and consistent movements that aid in advanced navigation, lesion crossing, and device manipulation during complex coronary and peripheral interventional procedures

### Swissray · Patient Table HA



#### Highlights

- Mobile multi-functional patient table with motorized height adjustment; battery operated and radiolucent surface. Ideally for x-ray or radiotherapy applications.
- Table height adjustment range from 55 to 95 cm
- Big double castors for easy and effortless movement
- Central brake pedal with 3 positions (1 wheel locked, 2 wheels blocked or free)
- Convenient table surface 192 x 66 cm with mattress



# Artificial Intelligence

**Canon**

**FUJIFILM**

 **GLEAMER**

**AGFA** 

**mindray**

**SCREENPOINT**  
Medical

**SIEMENS**  
**Healthineers** 

# Artificial Intelligence

## Artificial Intelligence

### Agfa HealthCare · Rubee for AI

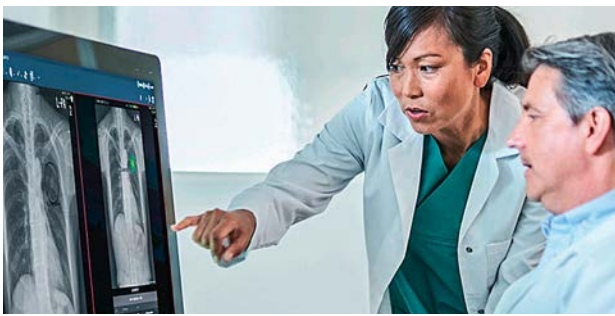

#### Highlights

Rubee for AI, as part of your Enterprise Imaging platform, offers a seamless AI experience for your clinicians. Carefully curated 'packages' embed best-of-class AI apps that work seamlessly to support your real clinical workflow from start to finish. With Rubee for AI, you get more out of your AI investments, while enriching the value of your Enterprise Imaging. It's a win-win-win for your hospital, your clinicians and your patients!

### Canon · Advanced intelligent Clear-IQ Engine for MR

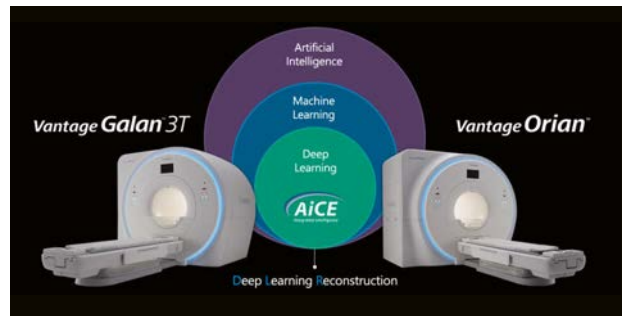

#### Highlights

The power of AI is brought to routine MR imaging by Canon Medical's Deep Learning Reconstruction technology: Advanced intelligent Clear-IQ Engine (AiCE). AiCE is the world's first fully integrated DLR technology for MR and produces exceptionally detailed MR images. AiCE intelligently removes the noise from the images, which results in higher SNR enabling increased resolution or decreased scan time.

### Canon · CT Image Reconstruction



#### Highlights

The power of AI is brought to routine and spectral CT imaging by Canon Medical's Deep Learning Reconstruction technologies: Advanced intelligent Clear-IQ Engine (AiCE), Precise IQ Engine (PIQE) and Spectral Reconstruction. AiCE is a fully integrated DLR technology for noise free CT images while PIQE reconstructs cardiac scan in super resolution. AI in Spectral Reconstruction results in a zero temporal off-set between low kV and high kV data sets.

### Canon · HIT Automation Platform



#### Highlights

Automation Platform is an AI-based, zero-click solution that uses Deep Learning technology to streamline your workflow for fast, actionable results every time. <sup>AUTO</sup>Stroke solution automatically analyzes images to fully characterize stroke conditions and integrates a comprehensive set of stroke applications:

- Non-contrast CT Intracranial Hemorrhage
- CT Perfusion maps
- CT Large Vessel Occlusion
- Aspects

Our solution for triage of life-threatening acute chest pain includes the following applications: Pulmonary Embolism and Aortic Dissection.

### Fujifilm · REiLI



#### Highlights

- Under the REiLI brand, Fujifilm is developing AI technologies that strongly support diagnostic imaging workflow.
- Leveraging the combination of deep learning and Fujifilm's image processing heritage.
- Working with both Fujifilm developed algorithms and market leading specialist vendors, the REiLI platform can automate alerts and send critical information directly to the relevant clinician.
- Increasing both the speed and accuracy of diagnosis and augmenting the decision-making process.

### Fujifilm · FDR EX-M1 AI box



#### Highlights

- Fujifilm expands AI CAD software integration across its portfolio.<sup>1</sup>
- Integration to AI CAD software including Lunit insight CXR, Qurei qXR provides Thorax AI-CAD abnormality scores by heatmap and ROI
  - Major chest abnormalities including nodule, consolidation, pneumothorax, atelectasis, fibrosis, pleural effusion, pneumoperitoneum, and mediastinal widening supported
  - Aid clinicians with the placement and measurement of devices placed in the thorax
  - Providing an advanced workflow and improved patient care pathway inside and outside the hospital

<sup>1</sup> Integration dependent on equipment configuration environment

Artificial Intelligence

Gleamer · BoneView & ChestView



Highlights

BoneView is your AI Companion for bone trauma X-rays: it detects fractures, effusions, dislocations and bone lesions. It aims to increase diagnostic performances by reducing missed fractures while improving reading time. ChestView is your AI Companion for Chest X-rays: it detects pneumothorax, pleural effusions, alveolar patterns, lung nodules, mediastinal/hilar masses, and helps increase diagnostic accuracy and detect abnormalities earlier. BoneView and ChestView are transparently integrated in your reading environment and are CE marked (Class IIA).

Mindray · ME



Highlights

The most innovative, advanced and high quality miniaturized ultrasound system ever designed by Mindray. ME is the first laptop ultrasound system powered by ZST+ platform. Its AI empowered analysis smart tools such as smart cardiopulmonary assessment solution, help to quickly assess patient hemodynamic and respiratory status under critical care environment. Stay unplugged all day with its super long battery duration for up to 8 hours scanning with U-bank.

ScreenPoint Medical · Transpara

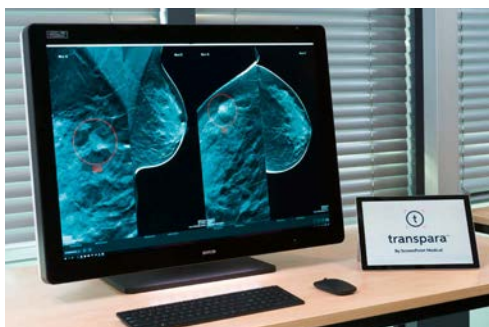

Highlights

ScreenPoint Medical is the leading developer of AI driven image analysis technology for automated reading of 2D and 3D mammograms. Transpara is in clinical use in over 30 countries and is the most advanced commercially available multivendor AI solution (CE marked and FDA cleared for 2D and 3D). Find us at ECR 2022 or visit <https://www.screenpoint-medical.com>

Siemens Healthineers · AI-Rad Companion



Highlights

The AI-Rad Companion, a family of AI-powered, cloud-based augmented workflow solutions, supports you in your diagnostic tasks and may increase your diagnostic precision when interpreting medical images. Its solutions provide automatic post-processing of imaging datasets through our AI-powered algorithms. The automation of routine workflows with repetitive tasks and high case volumes helps you to ease your daily workflow – so that you can focus on more critical issues.

BI

Siemens Healthineers · teamplay Mammo Dashboard

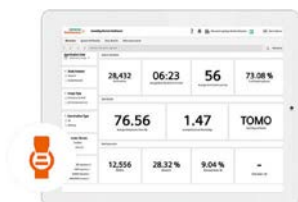

Highlights

teamplay Mammo Dashboard\* is specifically designed for breast care centers providing an intuitive overview of institution-specific KPIs to reveal workflow optimization potentials and support a high quality of care in breast imaging.

- Monitor your KPIs such as patient throughput, exam duration and study type to better understand your workflow
- Analyze scan details such as glandular dose and compression force to identify improvement needs and best practices
- Match staffing schedules with clinical demand of patients for capacity planning based on risk assessment data\*\*

\* teamplay is not commercially available in all countries. If the services are not marketed in countries due to regulatory or other reasons, the service offering cannot be guaranteed.  
 \*\* Breast density/ CAD software required

**RAD**BOOK 2022

Please visit us at  
**healthcare-in-europe.com**

# IT Systems

- RIS
- Business Intelligence
- PACS
- VNA
- Reading
- Remote Scanning
- Pathology
- Portal Solutions
- Utilities / Add-ons
- Mobile RIS / PACS Viewers
- Dose Management Systems
- Accessories / Complementary Systems

**AGFA**   
HealthCare

**Canon**

**EXAMION**<sup>®</sup>  
X-Ray Systems · Digital Imaging · Service

**Guerbet** | 

**FUJIFILM**

**BMS**  
INFORMATIONSTECHNOLOGIE® GMBH

 **IMAGE**  
Information Systems

 **I-SOLUTIONS**  
HEALTH

**medavis** 

  
**KONICA MINOLTA**

 **medigration**

 **nexus|chili**  
imaging & radiology solutions

 **OR Technology**

**SIEMENS**  
**Healthineers** 

**SWISSRAY**   
TECHNOLOGIES

RIS

Image Information Systems · iQ-Web RIS



**Highlights**

iQ-Web RIS is a flexible and modular web-based radiology information system, which can easily be customized to meet the needs of any hospital or imaging center.

- HTML5
- Advanced web-scheduling
- Flexible cross-site reporting
- Extensive statistics
- Secured access

i-Solutions Health · RadCentre Cockpit & Speech Integration

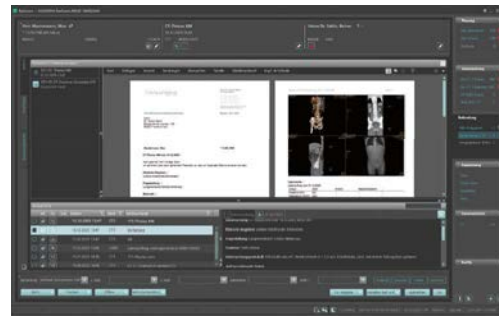

**Highlights**

RadCentre is a comprehensive process and data management solution for radiology, nuclear medicine and radiotherapy. Based on latest technologies it offers high usability with an innovative user interface (Cockpit) and most efficient reporting with integrated speech recognition.

- Integration of received reports (specification depends on cooperating system)
- Fast and efficient creation of reports for treatment without delay

medavis · medavis RIS – Radiology Information System



**Highlights**

medavis RIS manages the radiology workflow from appointment booking, examination, reporting to billing. The basis are optimal digital workflows and perfectly integrated interfaces to PACS, HIS and other systems. Additional modules support digital communication with patients, referring physicians or clinical staff.

medigration · RIS/PACS



**Highlights**

Our RIS/PACS solutions are designed for multisite and manufacturer-independent networks. The WinRadiolog RIS product portfolio implies the whole patient management for your medical institution. Our PACS product portfolio comprises a proven DICOM archive, an intuitive operating reporting 3D ImageVision workstation, teleimaging and mobile solutions, patient CD system dose management software solution..

Nexus/Chili · Nexus/RIS



**Highlights**

- Modern and intuitive user interface
- Scheduling and resource management
- Seamless integration with all our radiology products, e.g. PACS and portals
- Context-sensitive integration of 3rd party solutions, e.g. speech recognition, structured reporting and dose management
- Integration server for the management and monitoring of DICOM or HL7 interfaces
- Business intelligence tools

Business Intelligence

Agfa HealthCare · Enterprise Imaging Business Intelligence

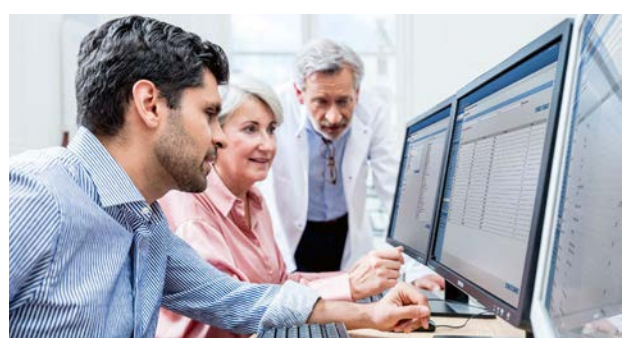

**Highlights**

Easy access to the information you need through standard and customizable reports. Your Enterprise Imaging solution contains a wealth of information about your healthcare enterprise and its operations. Agfa HealthCare Business Intelligence reports are a cornerstone in better understanding operational realities, identifying areas for focused improvement and help build efficiency gains.

Business Intelligence

Fujifilm · Synapse Value



Highlights

Synapse Value is the new generation, modular, and never-stop growing software Platform for managing in advanced ways the extended Diagnostic Imaging Workflow & Reporting needs of Healthcare Organizations, through state-of-the-art Informatics technologies.

Solutions based on Synapse Value can be built with limitless possibility, to cover complex clinical and administrative needs. Structured Reports with images and data are available through the creation of templates highly customized. Artificial and Business Intelligence engines are integrated effectively for complete information valorization.

i-Solutions Health · RadCentre Analytics



Highlights

RadCentre Analytics offers an integrated solution for specific data analysis and interactive reporting to increase performance in radiology.

- Predefined and high performant processing of operating figures
- Unlimited analysis options for optimisation of business outcomes
- Integrated data warehouse solution
- Visualization of radiation exposure extracted from PACS

medavis · cockpit4med Radiology Dashboard



Highlights

cockpit4med provides dashboards with key management data of a radiological facility in real time, independent of location and at any time. This accelerates the derivation of targeted measures and shortens response times. The solution uses the latest technologies and is intuitive to use.

Siemens Healthineers · teamplay



Highlights

teamplay applications for performance management in healthcare help you make quick and well-informed decisions by offering a clear overview of your clinical and operational performance data.\* The set of teamplay performance management applications gives you instant, centralized access to operational, technical and clinical data to help you optimize your operations and to deliver higher quality of care. Smart connections between the applications amplify the data insights and provide a seamless user experience.

\* teamplay Protocols and teamplay Fleet supports (selected) Siemens scanners  
Please contact your Siemens representative for more details

Siemens Healthineers · eHealth Solutions

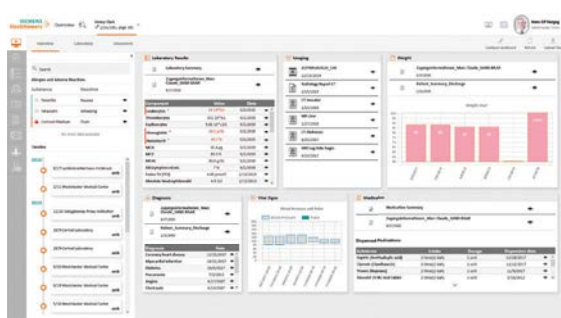

Highlights

eHealth Solutions fosters collaboration among healthcare providers, while enabling you to improve patient outcomes and increasing patient safety. Improved data transparency helps you to avoid unnecessary costs caused by duplicate examinations and additional administrative efforts and supports you in optimizing resources that may otherwise be tied to fragmented IT and infrastructure maintenance.

Siemens Healthineers · teamplay myCare Companion



Highlights

teamplay myCare Companion is a telehealth solution for management of a variety of chronic conditions. It enables integrated, centralized monitoring from a wide variety of third-party monitoring devices. An intuitive mobile app helps increase patient engagement – key to improving outcomes in chronic disease management – and helps patients connect to monitoring devices.

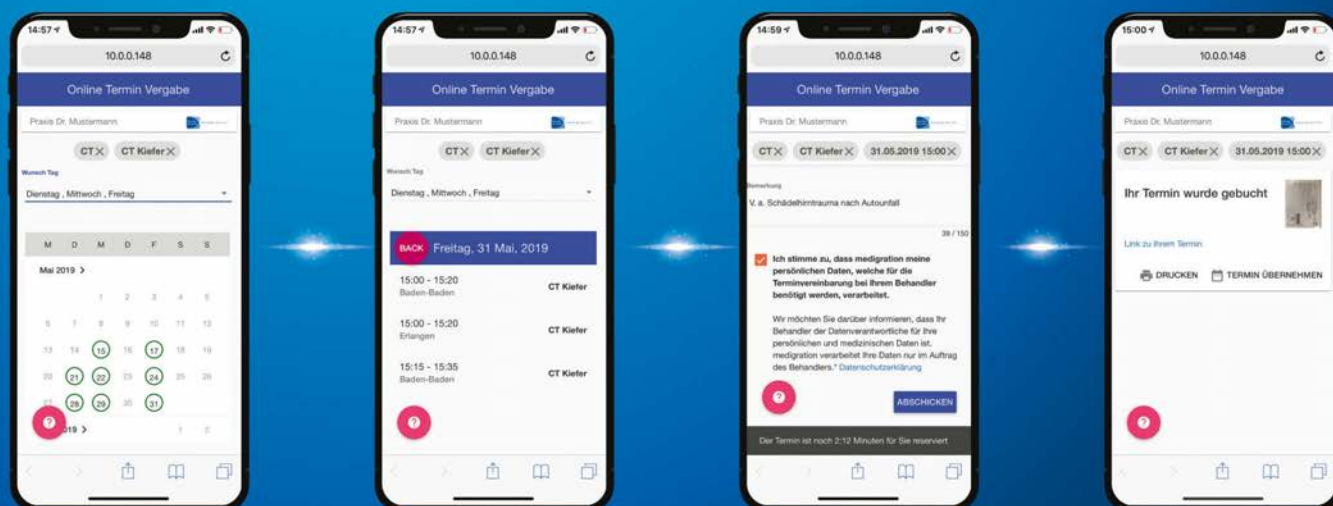

# Intelligent IT

## Online appointment scheduling for optimum equipment utilization in real-time

Over the past few years, modern appointment management has found its way into German medical practices. Nevertheless, there is significant room for improvement as some doctors can still be contacted only by phone and only during office hours. Now, medigration GmbH offers a solution: a web-based appointment scheduling system that is an add-on to the radiology information system (RIS). "Many commercially available appointment management systems are geared towards a wide range of medical specialties. We decided to create an add-on specifically for radiology practices and integrated it in our multi-portal platform," explains managing director Markus Steinlein.

Patient appointment scheduling in radiology can get very complex, particularly when different sites are involved, since the scheduling team have to ensure balanced imaging equipment utilization. Moreover, the many calls the scheduling team have to field and poor plannability – because patients are late or no-shows – strongly impacts overall practice management and indeed the economic sustainability of the radiology service provider. "We integrated appointment scheduling in our RIS to enable optimal equipment utilization in real-time," says Steinlein. In other words: all scheduling rules defined in the scheduling tool can be applied for online appointment booking. The add-on offers radiology practices a further communication channel with patients and referring physicians. Thus, the radiologists can control the types of services they want to offer.

The workflow of the appointment scheduler can be either automated or moderated. "A moderated process has the advantage that the patients can enter their preferred times and the staff can process these requests quickly," says

Steinlein. "Particularly with complex examinations this workflow leads to additional appointment bookings." Automated scheduling means that the scheduling team immediately see when an online request is being processed. "The moment a patient chooses a time slot, this slot is flagged in the scheduler. When the booking is completed, the appointment is fixed. If the patient abandons the booking process, the flagged time slot is available again."

### Mobile use

The add-on is available for desktop and for mobile devices. If patients book via a smartphone or tablet they can enter the time and day in their calendar and can even download additional information such as directions. "Moreover, the patients can take a photo of their referral document and upload it to the system," Steinlein reports. "Thus the required patient data doesn't have to be entered manually – which removes a potential source of error. At the same time, the moderated workflow includes the referral document which contains the type of exam the referring physician has requested."

### Privacy

Unlike other appointment scheduling systems, the medigration add-on is not strictly cloud-based. "A webserver is part of our multi-portal platform. Its main purpose is the transmission of images and reports, but with regard to the scheduler it is a secure link to the appointment planner in the radiology practice," says Steinlein. The data the patient provides in the course of the booking process is not permanently stored on the webserver but is simply passed through. "The actual data processing and storage happens in the radiology practice and the radiologist controls the data," Steinlein underlines.

[www.medigration.com](http://www.medigration.com)



*In 2000, Markus Steinlein completed his informatics studies at Georg Simon Ohm University of Applied Sciences in Nürnberg, Germany. From 1999 to 2003 he was managing director of WSO Informatik GmbH. In 2003 he joined medigration GmbH as a software developer and was appointed head of software development in 2010. Since 2014 Steinlein has been the company's managing director in charge of software development and quality management.*

**Markus Steinlein is managing director of medigration GmbH**

Business Intelligence

Siemens Healthineers · teamplay Usage

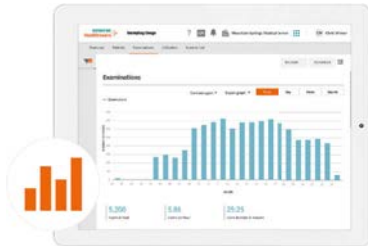

Highlights

teamplay Usage\* is an utilization management solution that helps to optimize imaging operations and increase efficiency. teamplay Usage brings workflow transparency in your radiology department, helping you to understand how to increase the productivity of your imaging fleet and balance resources more efficiently.

- Monitor your KPI's to better understand your workflow
- Drill down from a whole modality to a single procedure to discover patterns like long idle times and exam durations
- Identify best practice workflows by benchmarking between locations and scanners

\* Please check if teamplay is available in your country

Siemens Healthineers · teamplay Protocols

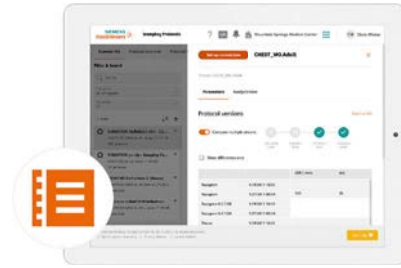

Highlights

teamplay Protocols\* is a protocol management system that facilitates remote access to your scanners, thus enabling central protocol management to ensure high quality of care and standardization throughout your whole organization.

- Perform systematic quality reviews easily
- Identify best practice scan protocols
- Save time and resources by remote editing, distributing and sharing protocols

\* teamplay Protocols is an application to manage scan protocols and edit protocols remotely by connecting to Expert-i. It does not directly influence the scanner in its operation. teamplay Protocols for eligible Siemens CT, MR and PET/CT scanners only

Siemens Healthineers · teamplay Insights



Highlights

teamplay Insights\* empowers well-informed decisions with deep data insights and clear, interactive data visualizations. Tackle your sophisticated challenges with the flexibility you need.

- Combine data sets and gain deeper performance insights into complex workflows and patterns
- Create a tailored dashboard to visualize your relevant data and KPIs the way you need it
- Set up interactive trackers and create standardized reports to pursue achievement of your performance targets

\* teamplay is not commercially available in all countries. If the services are not marketed in countries due to regulatory or other reasons, the service offering cannot be guaranteed.

PACS

Agfa HealthCare · Enterprise Imaging for Radiology



Highlights

Enterprise Imaging for Radiology is a unified imaging management platform that provides PACS, reporting, advanced image processing capabilities and integration of clinical information. The solution offers diagnostic tools and powerful task-based workflow, designed to achieve gains in productivity. The new Precision Reporting module combines predefined templates and customization with automations for enhanced decision making.

Examion · X-AQS



Highlights

Universal software platform for radiological image acquisition and management of all medical image data.

- High quality images in a few clicks
- Intuitive GUI with clear menu structure and icons
- Modular architecture, adaptable to all needs
- Certified diagnostic viewer with comprehensive measurement functions
- Convenient web viewer

Fujifilm · Synapse PACS



Highlights

Synapse PACS is a 100 percent web based, intuitive and scalable solution to meet your exact needs anywhere and at any time, with on demand access and fast image display. Synapse improves efficiency and workflow whilst enhancing access to patient data. Its scalable architecture enables the same product to be installed in any setting. Synapse offers integrated clinical tools, advanced visualisation modules and mammography functionality.



## PACS

## Image Information Systems · iQ-4CLOUD

**Highlights**

- Cloud PACS solution to access, view, store, import, print and share medical images efficiently and securely – without having to worry about IT issues
- Universal platform supporting virtually any data from any speciality
- Web-based image access through zero-footprint diagnostic viewer
- Flexible image viewing on smartphone, tablet, laptop or desktop PC
- Reduced IT costs and responsibilities

## Image Information Systems · iQ-System PACS

**Highlights**

iQ-System PACS is an easily configurable, highly scalable picture archiving and communication system. It is installed in more than 10,000 facilities ranging from small, individual, imaging centers to large multi-modality, multi-site hospital installations across more than 120 countries. It is full-featured, state-of-the-art, robust and reliable, and available in most major world languages.

## medigration · RIS / PACS

**Highlights**

Our RIS / PACS solutions are designed for multisite and manufacturer-independent networks. The WinRadiolog RIS product portfolio implies the whole patient management for your medical institution. Our PACS product portfolio comprises a proven DICOM archive, an intuitive operating reporting 3D ImageVision workstation, teleimaging and mobile solutions, patient CD system dose management software solution..

## Nexus / Chili · PACS

**Highlights**

- Multimedia PACS
- One viewer for all areas
- Scalable (practice to enterprise)
- Multitenancy
- Fail over and load balancing
- Archiving in existing systems
- Interfaces and synchronisation with HIS / RIS
- Supports multiple IHE workflows
- Referring physician access
- Teleconferencing
- Consultation
- Portal functionality

## Nexus / Chili · Import PACS

**Highlights**

- PACS for external data from CD / teleradiology
- Temporary archive in addition to regular PACS
- Manual web-based import
- Automatic import with import robot
- Data reconciliation with own IDs (IHE compliant)
- Delivery to regular PACS
- Adjustable automatic data removal
- DICOM Q/R capable
- Works with any other PACS

## OR Technology · dicomPACS

**Highlights**

dicomPACS is a sophisticated, high-tech image management solution based on VNA technology. With dicomPACS, all images generated by digital X-ray, CT, MRI and ultrasound devices, as well as diverse documents (e.g., doctors' letters ...) are stored in a digital patient folder and readily accessible. Our carefully designed archive and backup solutions guarantee quick access to all data and high security standards.

PACS

Siemens Healthineers · syngo.plaza

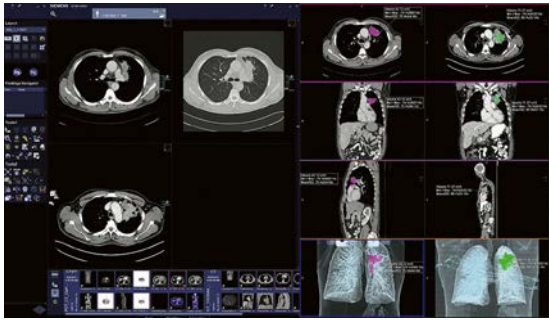

Highlights

- syngo.plaza is the smart PACS for reading and reporting a large variety of cases – from routine to complex.
- Centerpiece – robust performance, intuitive operation and intelligent reading tools
  - Smart PACS – 3D technology, powerful storage capacities and vendor-neutral archiving even enterprise-wide
  - Lasting investment – highly scalable long-term solution growing with your plans

VNA

Agfa HealthCare · Enterprise Imaging VNA



Highlights

A robust solution for enterprise archiving of DICOM and non-DICOM data. As part of the Enterprise Imaging solution, the VNA consolidates all your imaging data, from multiple systems, departments, facilities and vendors, into a central clinical data foundation. Your data ownership, migration and storage costs are reduced, while management is simplified.

Fujifilm · Synapse VNA



Highlights

Synapse VNA is our award winning (Best in KLAS 2019, 2020) Vendor Neutral Archive. It is the core building block of an enterprise imaging architecture, with a vendor neutral best of breed approach; it is a secure, scalable, standard-based application allowing clinicians and healthcare providers to access any relevant clinical object. Focused on all medical data, DICOM and native non-DICOM objects. Synapse VNA can also enable easy upload of content from the desktop or mobile device, helping Healthcare providers to reduce silos and ensure all data is available when a clinician needs it.

Nexus / Chili · Web



Highlights

- Multi-media (DICOM, JPEG, MPEG, PDF, ...)
- Very well suited for teleradiology
- Referring physician access
- User concept with roles and rights
- Central user administration (LDAP, AD)
- Security measures
- Data compression (lossy & lossless)
- Suited for reporting (MPG class IIb)
- Works with any PACS

Siemens Healthineers · next generation VNA

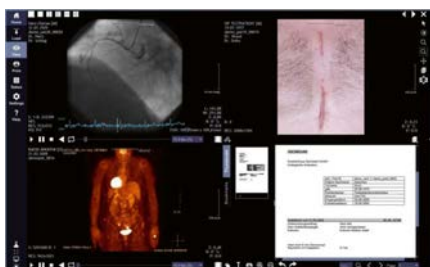

Highlights

- Enterprise-wide clinical image data management (IDM) made easy: Your data strategy to lead the future. IDM is the universal solution that meets the requirements of a powerful enterprise data management solution for managing, sharing and archiving clinical data independent of format and origin (DICOM and Non-DICOM). Scalable storage capacities allow data management across departments.
- Patient-centric storage
  - Single point of integration
  - Cost-saving data management
  - Virtual patient CD app
  - Universal zero-footprint enterprise viewer

Remote Scanning

Siemens Healthineers · syngo Virtual Cockpit



Highlights

- syngo Virtual Cockpit, a software for remote scanning assistance, lets you make the most of your imaging devices. Medical staff can use this software solution to connect remotely to scanner workplaces to assist personnel at a different location, especially where more sophisticated examinations are required.
- Boost confidence by sharing in-house expertise
  - Enhance patient satisfaction by improving availability
  - Relieve cost pressure by enhancing flexibility

Pathology

Fujifilm · Dynamyx



Highlights

Dynamyx is a vendor-agnostic, end to end digital pathology solution which can be integrated with any lab information system (LIS/LIMS) or digital slide scanner. Supporting LEAN workflow and collaboration (including online sharing). It allows pathology departments to move to digital at their own pace and allows the integration of any scanner or AI vendor via an open API throughout the life of the solution. The mature platform was designed by pathologists for pathologists and brings all of the tools to enable a pathology department to digitise and introduce LEAN working with minimal disruption and without any vendor lock in.

Reading

Canon · Vitrea Advanced Visualization

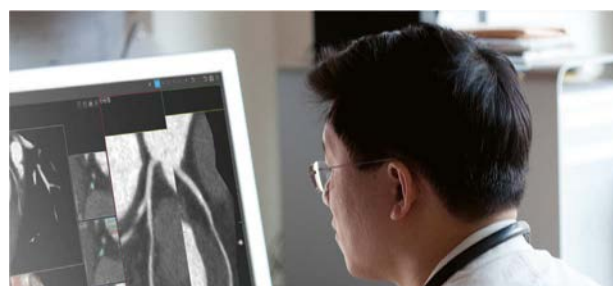

Highlights

- Suite of advanced applications provide full-powered solutions for 2D, 3D and 4D advanced visualization used to process and analyze clinical data from multiple modalities – MRI, CT, CR, DX, RG, RF, US, XA, NM, PET, PET/CT and SPECT
- Modular viewing platform that provides a broad range of clinical applications for cardiology, neurology, oncology, women’s health and MSK
- With multi-vendor support, Vitrea’s broad range of clinical applications can be used to read data for all the major vendors’ equipment

Fujifilm · Synapse 3D



Highlights

Synapse 3D is Fujifilm’s vendor-neutral advanced visualization platform with more than 50 clinical modules. The advanced pre-surgical planning tools allow surgeons & clinicians to plan the most efficient, least invasive surgical activities supporting clinical teams to provide the best possible patient outcomes.

Image Information Systems · iQ-View



Highlights

iQ-View is the vendor neutral easy-to-use multimodality reading station that has been designed by radiologists for imaging specialists. A unique previous study management using artificial intelligence accelerates the diagnostic process by automatically presenting relevant previous studies of any modalities. iQ-View Pro automatically merges different patient identities from any PACS.

Konica Minolta · Exa Enterprise Imaging



Highlights

- Cloud-delivered enterprise imaging platform featuring a single integrated database providing a unified view of your patient and patient care
- Zero footprint viewer plus server-side rendering enable viewing any modality from any location
- Specialized viewing tools, including 3D mammography, echo/stress echo and ortho
- Custom workflow engine enables Exa to meet unique workflow requirements and goals
- Advanced analytics and dashboards to optimize your imaging business

medigation · ImageVision

- Mammo MR
- Screening
- Calcium scoring
- CFA
- Coronaries / heart
- Lung
- EP planning
- Functional Imaging
- Stroke
- Vessel measurement
- Virtual colonoscopy



Highlights

- Easy to use, high performance examination and analysis system for radiological routines
- Access to all images (including previous images) within seconds
- Unique and hierarchical data compression without any loss
- Individually configurable hanging protocols
- Independent individual scaling of your interfaces

Reading

Nexus/Chili · Diagnost



Highlights

- Independent of modality
- CT, MR, CR, DR, PET, PET-CT, US, XA ...
- Mammography
- Radio therapy
- Powerful hanging protocols
- Independent of OS
- Integrated teleradiology
- Extensible by other applications
- HIS / RIS integration
- Consultation functionalities
- Teleconferencing

Siemens Healthineers · syngo Dynamics



Highlights

- syngo Dynamics is a single, enterprise wide, multi-modality intelligent reading and structured reporting platform to streamline data transfer and workflow. It helps enable high quality outcomes, efficient workflows, and improved operational efficiency
- Efficient workflows: Enables healthcare teams to quickly and easily access study data
  - Consistent data: Quickly connect to the right data and avoid missing or conflicting data, to enable high-quality outcomes and faster reimbursement
  - Simplify operations: A single platform that helps coordinate care across the continuum

Siemens Healthineers · syngo.via



Highlights

- syngo.via is the intelligent, integrated imaging software, which offers multi-modality and fast 3D reading, innovative and AI-powered applications. It speeds up your routine and provides actionable imaging based results to enhance care delivery and outcomes.
- Simplifying routine – streamlined reading and reporting with powerful tools and integrated reporting solutions
  - Empowering innovation – latest technologies and syngo.via open apps provide a gateway to innovations and boost your clinical capabilities
  - Adapting to you – integrating seamlessly into your IT environment and growing with all your medical and operational needs from workstation to multi-site

Portal Solutions

Image Information Systems · iQ-Web Portal



Highlights

- Share medical results, imaging studies and reports with your patients, referring or external reading physicians
- Access studies in full diagnostic quality via QR code, direct login or crypto web links
- Share portal access e.g. via WhatsApp, paper-based QR codes or direct HIS/RIS/EMR integration
- No client installation or registration required
- HIPAA and GDPR compliant patient data sharing

i-Solutions Health · RadCentre Patientenportal



Highlights

- The RadCentre Patientenportal supports image and report communication between doctors and patients and improves utilization in medical facilities and clinics.
- Efficient appointment management for optimized processes
  - Direct data exchange with referring physicians and patients
  - Provision of information sheets and consent forms before examination

medavis · booking4med Online Appointment Booking



Highlights

- booking4med is an online appointment solution for patients and referring physicians hosted in Germany. Thanks to the deep integration, appointments are automatically mapped in the medavis RIS scheduler. Patient data is handled with the highest security standards. No data is stored on the internet or in 3rd party systems.

Portal Solutions

medavis · portal4med Referrer and Patient Portal



**Highlights**

With portal4med, referring physicians have direct online access to their patients' radiological reports and images. Patients can access their own records online and make them available to other physicians. The data transmission is GDPR compliant and in accordance with the highest security standards.

medigation · MultiPortal



**Highlights**

- To connect your referring practices
- Efficient and encoded transferral of image data
- Secure, user-defined access control
- No elaborate VPN necessary
- Fast display of images and findings as PDF or SR
- For PC/ MAC: Intuitive, web-based tool, to be launched without any installation via any standard browser

medigation · webConnect

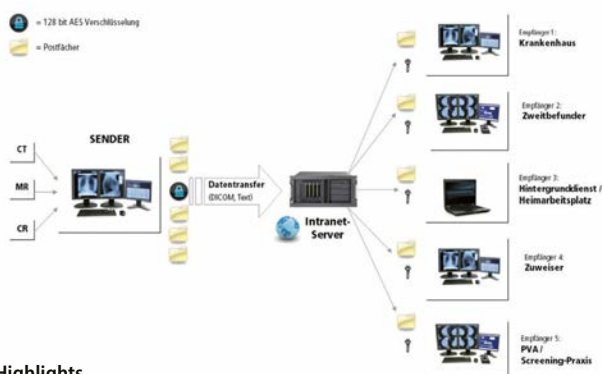

**Highlights**

- Uncomplicated exchange of image data via the internet
- Highly cost effective since only the actual transferred data is calculated
- No VPN connection necessary
- Images and results can be called up within seconds due to intelligent data compression
- Total security by means of 256 bit AES encryption

Nexus / Chili · Telemedicine Record

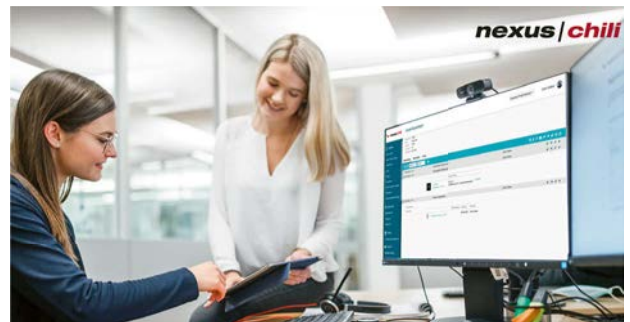

**Highlights**

- Web-based platform for the exchange of multimedia documents, e.g. diagnoses, lab results, DICOM images
- Capture, display and administration of patient data
- Forwarding to referring doctors
- Upload and download of DICOM and other images
- Inter-sector exchange of multimedia patient data
- Multicentre studies with DICOM images

Nexus / Chili · Teleradiology Gateway

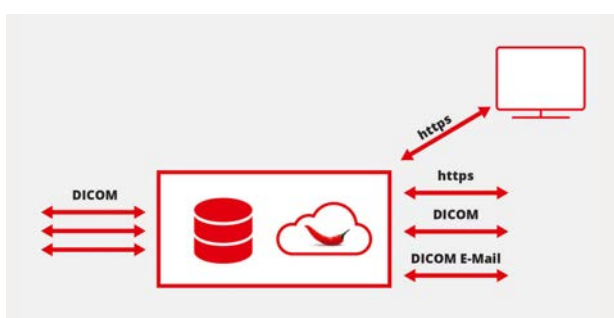

**Highlights**

- Vendor-independent protocols
- DICOM, DICOM E-Mail, HTTPS,
- Rule-based autorouting
- Automatic recovery after interruption
- Comprehensive security measures
- Lossy and lossless compression
- Data encryption
- Audit trails
- Diagnostic web-viewer
- Web-based administration
- Compliant to German StrlSchV and DIN 6868-159
- Works with any PACS

Nexus / Chili · Teleradiology Portal



**Highlights**

- Web-based portal that covers the entire teleradiological workflow
- Electronic request and reporting process
- Guided steps throughout the entire workflow
- Complete documentation of all steps
- Integrated quality assurance according to DIN 6868-159
- Transfer of images via DICOM
- Access to all data anywhere anytime
- Availability of data relevant to accounting

Portal Solutions

Nexus / Chili · Patient Portal

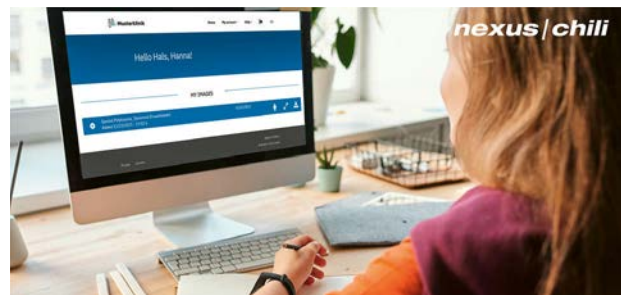

Highlights

- Progressive solution for the exchange of medical data between institutions and patients
- Digital alternative for physical patient CD
  - Protection of data privacy
  - Easy integration into RIS
  - Login via token, capture, and optional request of further information
  - Works with all smartphones or desktop computers; no installation required for patients
  - Automatic transfer of images from every PACS

OR Technology · ORCA – OR Cloud Archive



Highlights

- The medical cloud ORCA offers two exciting applications: ORCA Archive and ORCA Share.
- ORCA Archive transfers and stores image files from direct sources (e.g. digital X-ray, CT, MRI and ultrasound systems) as well as from Picture Archiving and Communication Systems (PACS). At the same time, ORCA is a platform for sharing data with external partners.
- The application ORCA Share facilitates exchanging images and medical findings with staff, colleagues and specialists.

Siemens Healthineers · teamply Images



Highlights

- teamply Images\* allows you to collaborate on imaging studies no matter where you are and no matter which device you are using in a secured way.\*\*
- Supporting your clinicians in their collaborations on to gain insights into complex cases
  - Access patient studies regardless of location or time that best fits your situation and technical capabilities
  - Share studies using a secure ground up infrastructure with confidence
- \* teamply is not commercially available in all countries. If the services are not marketed in countries due to regulatory or other reasons, the service offering cannot be guaranteed.
- \*\* internet connection is needed for access to the application, and a browser with HTML 5 is also needed for the desktop browser application. Within data privacy and datacenter restrictions.

# RADBOOK 2022

Please visit us at  
**healthcare-in-europe.com**

Utilities / Add-ons

Swissray · Cortex Protection Software

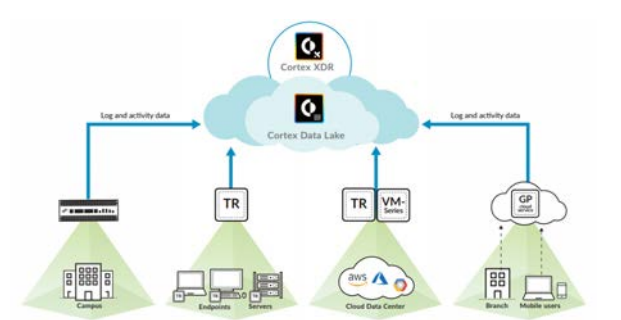

Highlights

- Best-in-class malware prevention for X-ray systems:
- Uncover threats with cloud AI and behavioral analytics
  - Prevent, detect, investigate and respond to all threats
  - Block known and unknown attacks with powerful endpoint protection
  - Validated by Swissray
  - Unique to the DACH region

Mobile RIS/PACS Viewers

Agfa HealthCare · Enterprise Imaging Platform



Highlights

- By seamlessly creating a comprehensive imaging health record and providing you with the tools to collaborate, exchange, view and manage images, Agfa HealthCare Enterprise Imaging supports you to build a system that will bring you clinical value all along the care continuum.

Mobile RIS/PACS Viewers

Agfa HealthCare · Xero Universal Viewer



Highlights

Enable borderless collaboration: Patient-centric image access from across all specialties in the enterprise, with enhanced viewing, collaboration and sharing, on a single web viewer. Xero Viewer provides secure access to imaging data from different departments and multiple sources, in one view, to anyone who needs it. With the mobile device support, you can truly work on the go, capturing and uploading images wherever you are.

Agfa HealthCare · Xero Viewer & Microsoft Teams Integration



Highlights

By integrating Xero Universal Viewer and Teams, Microsoft and Agfa HealthCare have created a secure virtual meeting space that enables “anywhere, anytime” instant connection and sharing, all from a single, familiar platform. Care team members from across multiple specialties can meet remotely to discuss medical cases and provide treatment-decision support, for efficient decision-making and improved delivery of clinical care.

Image Information Systems · iQ-4View



Highlights

iQ-4View is a ground-breaking diagnostic multimodality zero-footprint viewer, suitable for virtually all browsers and operating systems. It runs on almost any device (desktop computer, tablet PC or smartphone) and requires no installation on the client. iQ-4View allows reading, viewing or reviewing any kind of images, structured reports and Encapsulated PDFs.

medigation · MultiPortal



Highlights

- To connect your referring practices as PDF or SR
- Efficient and encoded transferral of image data
- Secure, user-defined access control
- Fast display of images and findings
- No elaborate VPN necessary
- For tablets & smartphones: Installation and updates easily via AppStore

Nexus/Chili · WebViewer<sup>NG</sup>



Highlights

- Mobile image viewer
- Teleradiology
- PACS administration
- Easy integration into any other system, such as HIS / RIS / PACS / EPR
- Works without an app store
- Independent of operating system (iOS, Android ...)
- Device independent (Apple, Google ...)
- No app – but HTML5!
- Works with any PACS

Dose Management Systems

Agfa HealthCare · Dose Monitoring System

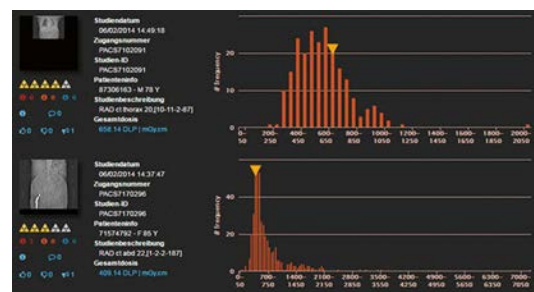

Highlights

The web-based Dose monitoring platform, integrates directly into existing picture archiving and communication system's (PACS) environment. Collecting the dose and metadata information already there, it can create patient radiation dose analyses at the study, patient, device, modality or institution level. It also provides all the tools you need for root cause analysis, to help you understand and solve potential problems. The Dose monitoring solution gives the tools needed to manage, analyze and balance the organization's radiation dose management.

Dose Management Systems

BMS Informationstechnologie · EasyDose<sup>QM</sup>



Highlights

EasyDose<sup>QM</sup> liberates care professionals from most time consuming manual tasks: acquisition, documentation, analysis and archiving. It utilizes DICOM, HL7 and integrates seamlessly within existing HIS / RIS and PACS systems. Dose information about individual patients, modalities and departments can be obtained without complicating search mechanisms with a few mouse clicks. EasyDose<sup>QM</sup> has been developed with the end-user in mind.

BMS Informationstechnologie · EasyDose<sup>QM</sup> – Options



Highlights

- EasyDose<sup>QM</sup> complementary options:
- Integration of measuring stations and column scales
  - RFID tracking of mobile devices, e.g. C-arms
  - GPU based Monte Carlo Simulation
  - HIS / RIS / PACS integration

Fujifilm · Synapse Dose

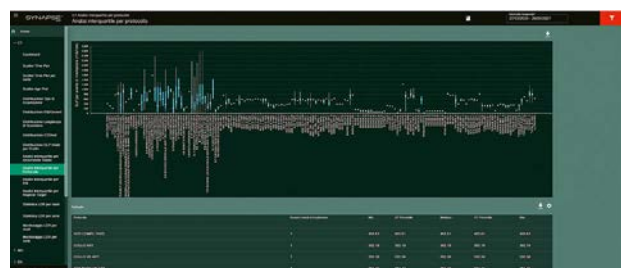

Highlights

Synapse Dose is a comprehensive system for monitoring and managing patient radiation exposure across different imaging modalities. It is a support for the optimization of radiological procedures and acquisition protocols, a tool for supporting clinical audit and it provides a comprehensive patient dosimetric history. General and specific dashboards track key performance indicators (KPI) to measure productivity, to achieve quality assurance and to support quality of care. Synapse Dose is the radiation dose index monitoring system developed by Fujifilm, compliant with the directive 2013/59/EURATOM of the European Union.

Guerbet · Contrast & Care

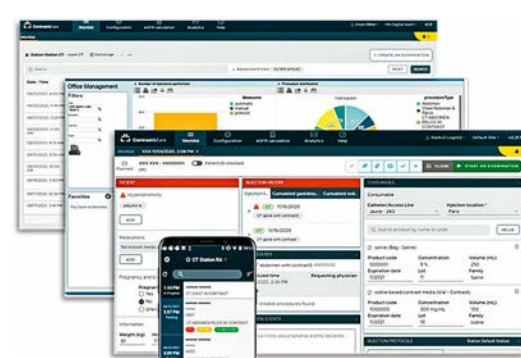

Highlights

Contrast&Care is a solution dedicated to contrast dose management. It connects to all Guerbet injectors and Hospital Information Systems (RIS, PACS, EMR. . .) and collects all relevant data about contrast media usage, patient history, and injector activity. Contrast&Care facilitates the traceability of contrast media and provides several tools that help imaging centers optimize contrast media consumption.

Guerbet · Dose & Care

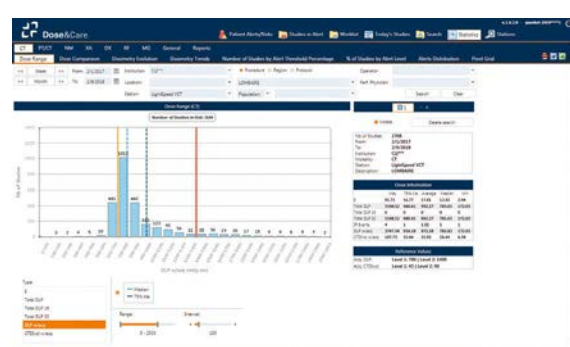

Highlights

Dose&Care is a state-of-the-art radiation dose monitoring solution, which allows documenting patient exams, understanding the reasons for excessive exposure and monitoring activities related to patient exposure. It provides the means to remain compliant with an ever-evolving regulation while improving the workflow and ensuring patient safety.

i-Solutions Health · RadCentre Dose View

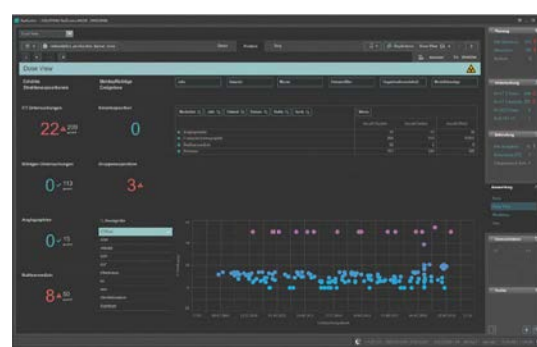

Highlights

RadCentre Dose View is a stand-alone and RIS-independent dose management system to assess patient exposures due to ionizing radiation. The system is able to meet legal requirements (i.e. EU-Directive EURATOM 2013/59 and related national regulations for radiation protection) by offering consistent standards to increase the quality of radiological examinations.



Dose Management Systems

mediation · Domako

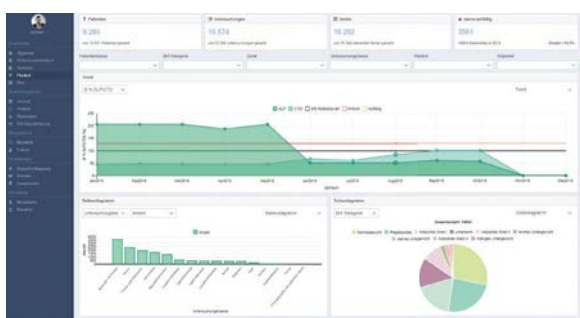

Highlights

Domako. Simple software solution for dose management (DM). Collects, classifies and evaluates dose data; graphs them. Efficiently control DM process. Optimize protocols of modalities purposefully. Observes dose guidelines of BFS. Holistic/detailed, be it in terms of individ. protocols, pat. groups or individuals. Fulfills function of an autom. X-ray book. Enables to react proactively to deviations. Web-based on-premises system. Can be integrated into other software systems.

Siemens Healthineers · teamplay Dose



Highlights

teamplay Dose\* simplifies radiation dose management for your entire imaging fleet by providing you with easy access to radiation dose data in order to reduce dose and facilitate compliance to dose management requirements.

- Simple monitoring and managing of dose values on various levels, ranging from all modalities to a single patient
- Find the outliers and understand the root causes to take corrective actions
- Learn from your peers by benchmarking dose values on global and national levels

\* Please check if teamplay is available in your country

Accessories / Complementary Systems

Canon · Advanced Edge Enhancement



Highlights

Enhanced visibility of catheters, fine structures and bones

- Better visualization of foreign structures in the image
- Enhanced display of fine structures
- Better definition of the structures in soft tissue and low dose areas
- Obtain enhanced images suitable for measurement or other applications
- Catheter, small structure and bone settings depending on the specific application
- Improved visibility of bone contours for easier measurement of length and angles

Canon · Scatter Correction



Highlights

Excellent image contrast without a grid. Canon's new image processing software Scatter Correction could reduce radiation dose by up to 60 percent on your radiographic examinations. Where a grid physically reduces scatter and thereby increases the image contrast, the software mimics this process virtually. The software works by creating a scatter model, which is subsequently subtracted from the image. The result is an image with reduced scatter and increased contrast. The software is available for Canon FPD imaging systems.

i-Solutions Health · RadCentre Technician Profile

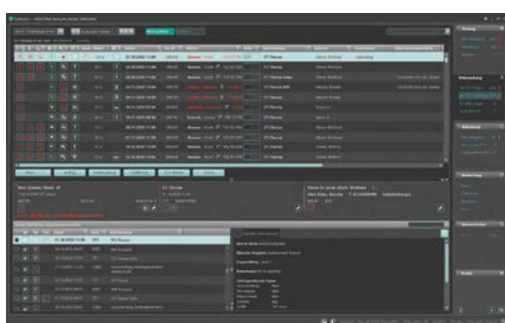

Highlights

RadCentre Technician Profile visualizes requested or performed examinations and reports at a glance and supports a fast and modality based workflow.

- Specific icons show examination status or patient information
- Images of prior examinations via integrated PACS viewer
- Interactive icons to change information or workflow status
- Scanned document files and laboratory results

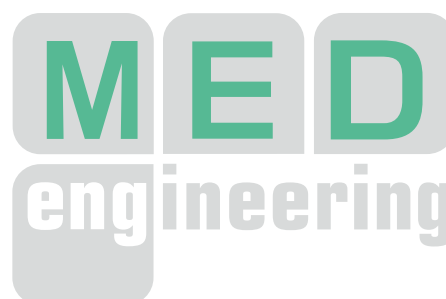

Please visit us at [med-eng.de](http://med-eng.de)

# Women's Health

Mammo CT  
Tomosynthesis  
Digital Mammography  
Biopsy Units  
Film-Screen Mammography  
Accessories /  
Complementary Systems

AB-CT



FUJIFILM

HOLOGIC®  
The Science of Sure



IMS  
Giotto

Planmed

SCREENPOINT  
Medical

PTW  
THE  
DOSIMETRY  
COMPANY

SIEMENS  
Healthineers

STERNMED®  
we make it possible

bender  
gruppe medigration

VILLA

**Mammo CT**

**AB-CT – Advanced Breast-CT · nu:view**

<b>Pixel size</b> 100 µm	<b>Scan time</b> 7 – 12 s	<b>Detector type</b> Photon counting
-----------------------------	------------------------------	---



**Highlights**  
Leading edge breast CT system for a revolutionary breast imaging experience

- Real 3D images with high isotropic resolution (voxel size: 150 µm)
- Superimposition-free, superb soft tissue differentiation
- Low dose in the range of mammograms
- Excellent patient comfort without compression
- Short scan and examination times
- Direct converting detector for highest sensitivity, accuracy and speed

**Tomosynthesis**

**Fujifilm · Amulet Innovality**

<b>Pixel output</b> 50 µm / 100 µm / 150 µm	<b>Scan angle</b> 15° / 40°	<b>Scan time</b> 4 s / 9 s
--	--------------------------------	-------------------------------



**Highlights**

- Unique Fujifilm developed a-Se detector using hexagonal pixels for dynamic readout of different resolutions
- New iterative reconstruction with new level of synthetic 2D image (S-View+) (Harmony) – corrected for low noise and better visibility of details, resulting in easy reading
- Ergonomic design for user and patients
- Dynamic image processing with advanced options like fine structure correction FSC and dynamic visualization II.
- Tomosynthesis biopsy, vertical and lateral approach
- CEDM; energy subtraction for mammography
- Dual angle tomosynthesis for dose efficient with maximum diagnostic performance

**Fujifilm · Amulet Innovality Harmony**

<b>Pixel size</b> 50 µm	<b>Scan angle</b> 40°	<b>Scan time</b> 4 s
----------------------------	--------------------------	-------------------------



**Highlights**  
The “Harmony” version brings together diagnostic performance with new design themes creating an environment to put your patients at ease. The new designs are pleasant and lively, and are created to make the mammography examination less stressful, promoting greater relaxation and comfort.

In addition to Amulet Innovality features, Harmony comes with: new iterative reconstruction, with new level of synthetic 2D image (S-View+) – corrected for low noise and better visibility of details, resulting in easy reading and Dynamic Visualisation II a dynamic image processing with advanced options like fine structure correction FSC.

**Hologic · 3Dimensions Mammography System**

<b>Pixel size</b> 70 µm	<b>Scan angle</b> 15°	<b>Scan time</b> 3.7 s
----------------------------	--------------------------	---------------------------



**Highlights**  
Reveal fine details with the fastest, highest resolution 3D Mammography exam using our advanced detector and innovative 3D imaging technologies designed to help detect more invasive cancers with confidence. With the integration of additional AI-powered solutions, the 3Dimensions is the smart, comprehensive platform supporting breast cancer detection, workflow optimisation and risk assessment.

**IMS Giotto – GMM Group · Giotto Class**

<b>Pixel size</b> 85 – 83 µm	<b>Scan angle</b> 30°	<b>Scan time</b> 11 s
---------------------------------	--------------------------	--------------------------



**Highlights**  
Giotto Class is an advanced and innovative three dimensional breast imaging technology able to perform

- Digital mammography examinations (2D)
- Breast Tomosynthesis (3D)
- Synthesized 2D image generated from 3D dataset
- Combo: Tomosynthesis & digital mammography
- Stereotactic and tomo-guided biopsy in prone or upright position
- Contrast-Enhanced Spectral Mammography (CESM)

IMS Giotto is a company of GMM Group

**Planmed Oy · Clarity 3D**

<b>Pixel size</b> 83 µm	<b>Scan angle</b> 15°	<b>Scan time</b> 13 s
----------------------------	--------------------------	--------------------------



**Highlights**

- Digital mammography system for conventional 2D imaging, diagnostic imaging, stereotactic biopsies and Digital Breast Tomosynthesis (DBT)
- Continuous Sync-and-Shoot tomosynthesis imaging method with iterative reconstruction and Tomo-Marker technology to enable sharp and artifact free images
- Intuitive Planmed Clarity Flow touch screen based user interface

## Tomosynthesis

### Siemens Healthineers · 50° Wide-Angle Tomosynthesis

Pixel size 85 µm	Scan angle 50°	Scan time 25 s
---------------------	-------------------	-------------------

#### Highlights

- Advance screening and diagnostic results with high accuracy. 50° Wide-Angle Tomosynthesis has proven an increase in cancer detection rate of 41.5% for invasive cancer – with a one-view tomo scan only.
- Highest depth resolution with 50° Wide-Angle Tomosynthesis
- Gain a fast overview – with our synthetic visualization Insight 2D
- 40% dose reduction as opposed to FFDM as an adjunct to tomosynthesis
- Decrease tomo reading time - with our unique, synthetic visualization Insight 3D a unique, rotating 3D display in breast tomosynthesis



### Siemens Healthineers · Mammomat Revelation

Pixel size 85 µm	Scan angle 50°	Scan time 25 s
---------------------	-------------------	-------------------

#### Highlights

- State-of-the-art digital mammography system for screening and diagnostics
- Make anatomical details clearly visible with our unique 50° Wide-Angle – in Tomosynthesis and Biopsy
- Automated breast density measurement right at the acquisition workstation allows for instant risk stratification
- InSpect – our integrated specimen scanner facilitates the immediate control of the biopsy directly at the system
- Get additional diagnostic information fast with Titanium Contrast Enhanced Mammography
- Unlock the potential of your X-ray department with Fleet Level Benefits



### Villa Sistemi Medicali · Melody IIID TS 3.0

Pixel size 85 µm	Scan angle 15° / 24° / 50°	Scan time 2.5s / 4s / 7.7s
---------------------	-------------------------------	-------------------------------

#### Highlights

- Tomosynthesis function with selection of three scan angles: 15°, 24° and 50°
- Available with Amorphous Selenium FPD (standard or fast speed for tomo scan)
- Special anti-scatter grid for tomo
- Dynamic collimator with automatic recognition of compressor paddle
- Dual AEC: PRE in function of effective Breast Density and FAST in function of compressed breast thickness
- Full DICOM Acquisition workstation on-board or in a separated unit
- Ready for tomo-guided biopsy
- Ready to be implemented with Dual Energy work modality
- Optional diagnostic workstation available with CAD software



## Digital Mammography

### IMS Giotto – GMM Group · Giotto Class 40000

Pixel size 85 – 83 µm	Detector size 24 × 30 cm	Detector type a-Se or a-Si
--------------------------	-----------------------------	-------------------------------

#### Highlights

- The system is designed to drastically improve the screening and diagnostic throughput thanks to a high rotation speed and an improved vertical run speed
- The gantry is ergonomically designed to give patients a natural and more relaxed positioning
- The operating and interventional modalities include:
  - Digital mammography examinations (2D)
  - Breast Tomosynthesis (3D)
  - Synthesized 2D image generated from 3D dataset
  - Combo: Tomosynthesis & digital mammography
  - High precision tomo guided or stereotactic biopsy
  - Contrast-Enhanced Spectral Mammography (CESM)
- IMS Giotto is a company of GMM Group



### IMS Giotto – GMM Group · Giotto Class Smartfinder

Pixel size 85 – 83 µm	Detector size 24 × 30 cm	Detector type a-Se or a-Si
--------------------------	-----------------------------	-------------------------------

#### Highlights

- Giotto Class is a patented breast tomosynthesis system offering a multitude of diagnostic and interventional solutions, including Stereotactic and Tomo-guided biopsy in prone or upright position using the specific prone table accessory.
  - High precision tomo guided biopsy
  - Combination of traditional stereo technique and tomo biopsy
  - Integration with accessory for real-time acquisition of biopsy cores imaging
  - The compact design allow the operator to use the system in the same room for both diagnostic and interventional procedures
- IMS Giotto is a company of GMM Group



### Planned Oy · Clarity 2D

Pixel size 83 µm	Detector size 24 × 30 cm	Detector type a-Si
---------------------	-----------------------------	-----------------------

#### Highlights

- Intelligent Planned Clarity Flow dual touch screen user interface that adapts to different imaging modes
- Image post processing that can be tailored to radiologist preferences
- Side access for optimal patient positioning and user ergonomics
- Integrated MaxView breast positioning system for maximal tissue visibility
- Easy field upgrade to Planned Clarity 3D digital breast tomosynthesis



Digital Mammography

**Planned Oy · Clarity S**

Pixel size 83 µm	Detector size 24 × 30 cm	Detector type a-Si
---------------------	-----------------------------	-----------------------



**Highlights**

- Sturdy companion for your everyday breast imaging and follow up studies
- Tailored image post-processing delivers optimal images for all needs
- Design enables perfect usability and excellent patient and user ergonomics
- Compact size, durable a-Si detector and single phase power feed make the unit optimal for demanding conditions such as mobile installations

**Siemens Healthineers · Mammomat Fusion**

Pixel size 83 µm	Detector size 23 × 30 cm	Detector type CsI
---------------------	-----------------------------	----------------------



**Highlights**

- Premium mammography system to enhance everyday screening and diagnostics
- Help your patients to relax with the Mood-Light option
- Stereotactic biopsy option for fast seamless procedures
- New generation CsI detector technology for higher spatial resolution at low dose
- Refined workflow to perform complex tasks at the click of a button
- Personalized OpComp and OpDose
- Focus on total cost of ownership including operating costs and service
- Unlock the potential of your X-ray department with Fleet Level Benefits

**SternMed · Xenox S200**

Pixel size 49.5 µm	Detector size 24 × 30 cm	Detector type CsI
-----------------------	-----------------------------	----------------------



**Highlights**

- Direct Conversion detector
- Tomosynthesis option with wide angle of 50°
- 7,5kW power with 300KHU Anode
- Motor-driven adjustable force with safety release compression
- Automatic Collimation and filtration according to the installed compression paddle
- Iso-centric c-arm
- Fully motorized movement
- Automatic Exposure Control (AEC)
- Acquisition console with 3MP B/W monitor and transparent anti-X protective barrier
- Full Field digital stereotactic biopsy

**Villa Sistemi Medicali · Melody IIID C 3.0**

Pixel size 85 µm	Detector size 24 × 30 cm	Detector type a-Se or a-Si
---------------------	-----------------------------	-------------------------------



**Highlights**

- High performance integrated X-ray generator with wide kV range (20 – 35 kV) and fine adjustment (0.5 kV step)
- Isocentric ±180° rotating C-arm with vertical and rotation (optional) motorized movements
- Available with Amorphous Selenium FPD
- Dual AEC: PRE in function of effective Breast Density and FAST in function of compressed breast thickness
- Double touchscreen LCD display to control main parameters
- Compact unit with full DICOM acquisition workstation on-board
- Optional diagnostic workstation

**Villa Sistemi Medicali · Melody IIID 3.0**

Pixel size 85 µm	Detector size 24 × 30 cm	Detector type a-Se or a-Si
---------------------	-----------------------------	-------------------------------



**Highlights**

- High performance X-ray generator with wide kV range (20 – 49 kV)
- Isocentric ±180° rotating C-arm with vertical and rotation motorized movements
- Dual AEC: PRE in function of effective Breast Density and FAST in function of compressed breast thickness
- Ready for optional stereotactic biopsy
- Full DICOM Acquisition workstation on-board or in a separated unit
- Upgradable to TS version with tomo
- Ready to be implemented with Dual Energy work modality
- Optional diagnostic workstation available with CAD software

**Biopsy Units**

**Hologic · Faxitron Trident HD Specimen Radiography System**

Pixel size 70 µm	Detector size 16 × 18 cm	Detector type a-Se
---------------------	-----------------------------	-----------------------



**Highlights**

The Faxitron Trident HD system elevates specimen imaging. It's the latest device to use our amorphous selenium, direct-capture technology to eliminate the image degrading effects of light diffusion and improve image conspicuity. The system's Automatic Exposure Control (AEC) is optimized for breast excisions and core biopsies, and its advanced algorithm was created specifically for breast specimen radiography processing. Faxitron Trident HD turns images into answers – on the spot.

# Improving Workflow and Patient Care Through Innovation

Groundbreaking technologies have improved our ability to accurately diagnose breast cancer and reduce callbacks, focusing on compassionate care for patients as they move along their breast health journey. As healthcare providers, we must assess the benefits of new technologies in terms of workflow including any added workflow challenges that might inhibit our primary objective of early diagnosis.

Global champion for women's health Hologic is supporting healthcare professionals to align their own workflow with patient access through our ecosystem of advanced technologies that integrate across the breast health continuum of care. When used together, these technologies provide a more comfortable patient experience, greater clinical confidence and business efficiencies that improve workflow.

## Improved cancer detection and reduced Interpretation Time

Fast, accurate diagnosis is key to compassionate care for patients; however, as imaging technology improves, radiologists have increasingly more images to interpret. Artificial intelligence (AI) offers unique solutions to this challenge that will help speed up reading times as well as efficiently evaluate images and flag areas of concern.

Recent research suggests deep learning AI can augment radiologist performance and act as a second reader for most scans, helping to shorten the time between exams and diagnosis by analysing images using advanced and diverse datasets.





While AI systems may have fallen short in the past, Hologic's Genius AI technology uses improved aggregated datasets compared to previous generations. The software can now identify calcifications, architectural distortions and masses, and then highlight these findings of interests in real time. This advanced technology can help radiologists focus on the high-priority cases that need quicker attention.

The adoption of tomosynthesis combined with AI technology's such as 3DQuorum also presents opportunities both to further improve cancer detection and to create better efficiencies in workflow. 3DQuorum technology utilizes Genius AI-powered analytics to uniquely reconstruct high-resolution 3D Mammography data to produce 6mm SmartSlices. This technology reduces the number of 3D images to review is reduced by two-thirds<sup>1,2</sup>, leading to an average interpretation time savings of one hour per day, based on eight hours of image interpretation time per day.<sup>2,3</sup>

For radiologists this reduction in the number of images they have to review, besides saving time could also help reduce reader fatigue and improving reading workflow. For women, this could mean earlier cancer detection and better treatment options in the longer term as AI will support a move to more personalised medicine.

## Integrated Technologies

Breast biopsy procedures provide life-saving diagnosis of lesions and calcifications and are one of the most important tools in the continuum of breast care for patients. They are an integral part to the diagnostic process. Traditionally, breast biopsies can require more than a dozen samples without assurance that a specimen has been acquired. During this time, radiologists need to leave the patient in compression to image samples for a confident diagnosis.

Hologic's Brevera Breast Biopsy system is the world's first and only breast biopsy solution to combine vacuum-assisted tissue acquisition, real-time imaging, verification and advanced post-biopsy handling – all in one, integrated system.<sup>4</sup> The system enables radiologists to view samples through real-time imaging that enables confidence in tissue acquisition – all without the need to handle specimens or leave the patient during the procedure. The innovative design of the system enables procedural steps to be reduced from eight to five, which means ten minutes on average saved per patient. This means less time under compression for the patient and more time back for the radiologist enabling them to see more patients.<sup>5,6</sup>

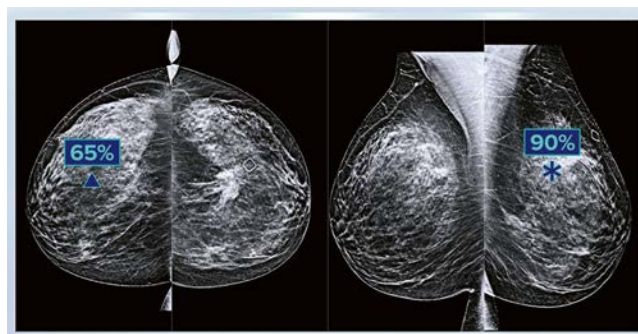

## Improved Image Quality

Digital specimen radiography provides the imaging answers we need to diagnose and ensure proper removal of suspicious lesions following procedures. However, clear, high-resolution images are key to these answers.

Hologic's Faxitron Path + system provides optimal imaging for large or thinly sliced specimens, resulting in fewer re-cuts. Designed with field-of-view guides and automatic position detection, the Faxitron Path+ system can image down to the smallest microcalcifications. With its automated exposure settings, pathologists can ensure the highest image quality of breast tissue slices to bone decalcification, which allows for more accuracy and faster report generation.

With Hologic's innovative technologies, healthcare professionals can save time and energy through integrated hardware and software solutions that work together across platforms to help ease the patient journey and create an ecosystem for personalized care.

Find out more: <https://www.3dimensionsmammography.eu>

1 MAN-06029. 3DQuorum.

2 MAN-06153. Dimensions Breast Tomo

3 Hologic data on file. CSR-00116

4 Hologic Data on file. VAR-05326 Brevera Unmapped Requirements Verification & Validation Report Attachment, Name - VAP 03172. Section: Test Data Summary, page 12,18

5 MISC-07678-EUR-EN\_001\_01 Brevera pulse wave 2 report inspired insight 2019, section: appendix wave 2, table, page 19

6 MISC-07662-EUR-EN\_001\_01 Foundational Research For Breast Imaging And Biopsy – Kadence – March 2015. Section: Stereotactic Biopsy Workflow & Challenges, page 25

Biopsy Units

Hologic · Faxitron Core Specimen Radiography System

Pixel size 48 µm	Detector size 5 × 10 cm	Detector type a-Se
---------------------	----------------------------	-----------------------



Highlights

The Faxitron Core Specimen Radiography System helps to minimise delays by providing high resolution images without interrupting the mammography workflow. Within seconds this self-contained, tabletop unit provides high-resolution imaging for immediate core sample verification in the biopsy room. With one touch of a button, a successful biopsy procedure is confirmed. The Faxitron Core system is designed for efficiency.

Hologic · Affirm Contrast Biopsy\*

Pixel size —	Detector size —	Detector type —
-----------------	--------------------	--------------------

Highlights

Affirm Contrast Biopsy solution is designed to simplify the breast biopsy process – even for challenging procedures. The software is designed to guide the biopsy of lesions using 2D CEM images for targeting. Following the initial I-View diagnostic mammogram, a biopsy can be performed using a platform that customers trust: Hologic's mammography system with the Affirm breast biopsy guidance system.

*\*Not CE marked. Not available for sale. Not for distribution. CE Mark expected in April*



Hologic · Affirm Prone Breast Biopsy System

Pixel size 70 µm	Detector size 14.3 × 11.7 cm	Detector type a-Se
---------------------	---------------------------------	-----------------------



Highlights

The first dedicated prone stereotactic biopsy system with 2D/3D imaging capabilities. The Affirm system provides exceptional 2D imaging capability and is upgradeable to 3D imaging. This next-generation solution elevates prone biopsy performance to a level never before possible by delivering superior imaging, a proven faster and more streamlined workflow, and total 360 access to the breast.

Hologic · Brevera Breast Biopsy System

Pixel size 20 µm	Detector size 3.3 × 2.5 cm	Detector type a-Se
---------------------	-------------------------------	-----------------------

Highlights

The Brevera breast biopsy system with CorLumina imaging technology is the world's first and only solution to combine tissue acquisition, real-time imaging, verification and advanced post-biopsy handling – all in one, integrated system. It is designed to remove unnecessary steps to streamline and shorten procedure times by up to 10 minutes. Fast, accurate procedures mean less time under compression and can result in an more positive experience for you and your patients.



IMS Giotto – GMM Group · Giotto Flexible

Pixel size 85 – 83 µm	Detector size 24 × 30 cm	Detector type a-Se or a-Si
--------------------------	-----------------------------	-------------------------------

Highlights

Flexible is an accessory which, in combination with the Giotto CLASS system and the Smartfinder biopsy kit, enables interventional prone biopsy procedures

- High manoeuvrability, thanks to its reduced weight, the handle and the special wheels
- Excellent ergonomics for the patient thanks to the possibility of adapting the position of the breast and inclining or raising the front end of the table to compensate for bending and come into closer contact with the chest
- Excellent ergonomics for the operator: thanks to the large vertical travel, which makes it possible to work either standing or sitting, and the absence of connecting cables when the table is powered by the battery

IMS Giotto is a company of GMM Group



**RADBOOK 2022**

Please visit us at  
**healthcare-in-europe.com**



Film-Screen Mammography

**Siemens Healthineers · Mammomat Select**

Power	Anode	Filter
23 – 35 kV	Mo	Mo / Mo or Mo / Rh



**Highlights**  
An analogue system that is easy to use, provides images at the right dose and is cost-effective to offer women the standard of care they need

- Easy touch screen control for streamlined workflow
- Easy to dose right with AEC control
- Easy to invest with flexible service and upgrades
- Unlock the potential of your X-ray department with Fleet Level Benefits

**Villa Sistemi Medicali · Melody III 3.0**

Power	Anode	Filter
20 – 35 kV	Mo	Mo / Rh



**Highlights**

- High performance integrated X-ray generator with wide kV range and fine adjustment (0.5 kV step)
- AEC with selection of exposure parameters in function of effective breast density
- Available with 18 × 24 / 24 × 30 cm bucky or potter accepting both cassette sizes
- Isocentric ± 180° rotating C-arm with vertical and rotation (optional) motorized movements

- Ready for optional stereotactic biopsy
- Double touchscreen LCD display to control main parameters
- Upgradable to digital version

Mammo Workstations

**Fujifilm · Amulet Bellus II**



**Highlights**

- Multi modality diagnostic workstation
- Tomosynthesis reconstruction for time saving image transfer
- Customizable GUI and workflow
- Report functionality and 3rd party report integration
- Can be integrated into existing environments
- Up to five clients

**Hologic · I-View 2.0 Contrast Enhanced Imaging**

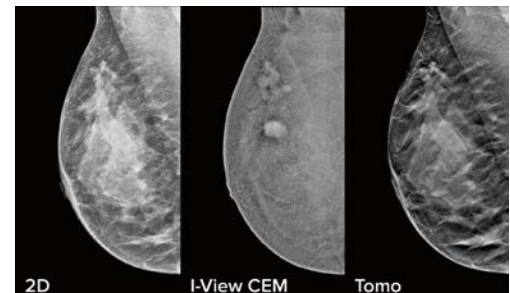

**Highlights**  
I-View CEM software can capture both anatomical and functional information in 1 exam by leveraging the ability to provide 2D, Contrast and Tomo images all under 1 compression. The smooth, lower dose contrast image preserves the high-definition image quality helping increase diagnostic confidence guiding the clinical pathway from diagnosis to surgical management as an effective and more patient-friendly alternative to MRI<sup>1</sup>.

1: Patel BK, et al, Potential Cost Savings of Contrast-Enhanced Digital Mammography; AJR Apr 2017; Jun; 208 (6): W231–W237.

Hologic · Quantra 2.2 Breast Density Assessment

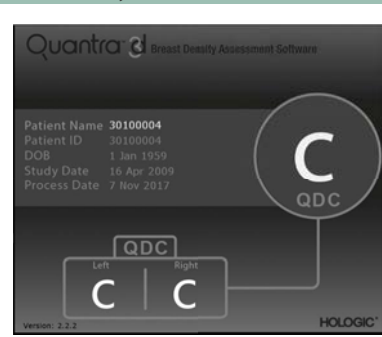

**Highlights**  
Powered by machine learning analysing each patient's individual breast tissue pattern and texture, Quantra allows the radiologist to confidently assess a breast density category based on a four-point scale similar to Bi-RADS 5th Edition. Quantra 2.2 is integrated on the acquisition workstation and can help facilitating the implementation of high-risk/density-based patient management protocol at the point of care.

medigation · MammoView

- Default display protocol
- Hi-Res displays or mixed setups
- Digital dictation integration
- Dedicated keypad
- WebClient



**Highlights**

- Extremely easy to use and manage
- Direct findings in the image
- CAD support (optional) and a second view area to examine US and MRT images

- Hanging protocols can be configured individually to automate your routine workflow
- Outstanding image quality (2,048 greyscale)



# ACCURATE REAL-TIME IMAGING LEADS TO BETTER BREAST BIOPSY PATIENT EXPERIENCE

When it comes to your patient's health, certainty matters. Breast biopsies play a vital role in the continuum of care for women, providing insights into mass and calcification identification so you can make the best-informed decisions on behalf of your patients.

Hologic's Brevera Breast Biopsy system is the world's first and only breast biopsy solution to combine vacuum-assisted tissue acquisition, real-time imaging, verification and advanced post-biopsy handling – all in one, integrated system.<sup>1</sup>

The Brevera system stands out from traditional breast biopsy systems that are inefficient for physicians, radiologists, and patients by providing real-time answers you can feel confident passing onto your patients.

After 25 years in the field as a breast radiologist, Dr. Lidy Wijers at Arijne Hospital in Leiderdorp, Netherlands, recommends the Brevera system because of its real-time results and accuracy, which has enabled her hospital to provide a better patient experience and improve workflow.

**"Hologic's Brevera system offers the most important breakthrough in all biopsy systems."**

## Verified Real-Time Imaging

Dr. Wijers recalls her experiences before the hospital acquired the Brevera system, and the uncertainty they experienced with traditional procedures. Previously, radiologists would acquire samples and place them in petri dishes, which would be taken into another room and imaged with a mammography machine.

With the Brevera system, samples can be verified in real time through the integrated specimen chamber that incorporates CorLumina® imaging technology. This unique technology allows physicians to make informed clinical decisions with confidence and save valuable time. The built-in image enhancement tools enable quicker identification of faint calcifications on the high-resolution touch-screen monitor.

Because of the CorLumina system, images begin to appear after just a few samples are taken and can help guide physician decisions throughout the process. Compare this to traditional systems, which can require a physician to keep a patient under compression while they examine sometimes 12 or more samples in another imaging room.

“Hologic’s Brevera system offers the most important breakthrough in all biopsy systems. While taking samples of the breast, the specimen is verified in real-time. It’s unique and gives more certainty to patients and radiologists,” said Dr. Wijers. “Patients can feel confident that specimen were captured without the radiologist leaving the room.”

### Improved Patient Experience

Dr. Wijers strives to provide compassionate care to her patients, and she chose the Brevera system in hopes of reducing patient anxiety and fears around their breast biopsy experience. With this system, patients are under compression for less time because she’s able to gather samples in only three steps, combining tissue acquisition, imaging, verification, and sample prep for an optimal experience, with the potential to save 13 minutes on average per patient.<sup>2</sup>



Fast and accurate procedures mean less time under compression for patients and can result in a more positive biopsy experience – so much so that 9 out of every 10 patients felt less uncomfortable with their Brevera breast biopsy procedure than they expected.<sup>3</sup> Additionally, patients felt their biopsy experience was faster than they expected in over 94% of procedures with the Brevera system.<sup>3</sup>

While patients are under compression for less time, they’re also reassured by the real-time imaging that samples of the mass or calcification were correctly captured with instant core verification.<sup>1</sup> Dr. Wijers says patients are often relieved when they can see the results right away without having to wait for additional procedure steps.

“I call this the positive post-biopsy experience,” said Dr. Wijers. “The Brevera system is quick and accurate, saving us time with the real-time images of the specimen. The procedure is shorter, which is always a relief to the patient.”

### Optimized Workflow

With the integrated specimen chamber built into the system, Dr. Wijers noted that radiologists no longer need to handle the samples and take them into another room for imaging.

With a traditional breast biopsy procedure, samples are taken into a different room while patients remain under compression. The sample strands are separated to analyze for calcifications and then, the

radiologist will return to the room to retrieve more samples or finish the procedure. In comparison, with the Brevera system, it’s all completed in one location.

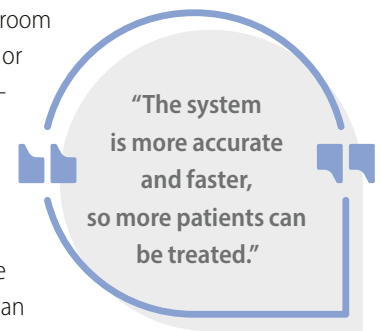

“The system is more accurate and faster, so more patients can be treated,” said Dr. Wijers. “We no longer need the second imaging room, so now it can be used for another patient or to make images of a specimen coming from the OR.”

The Brevera biopsy system enables more flexibility within the facility through its accurate and succinct imaging process and improved workflow so there is less time for patients to wait between mass identification and their biopsy. This compassionate care helps patients undergo a better biopsy experience.

Learn more at: <https://www.Hologic.com/MinutesMatter>



1 Hologic Data on file: VAR 05326  
 2 Inspired Insight online survey, April 2019 with 49 Brevera® users.  
 3 Results from, “A Prospective, Block Stratified Clinical Trial to Evaluate the Performance and Operation of the Brevera® Breast Biopsy System” (NCT03300206) (US)

Mammo Workstations

Siemens Healthineers · syngo.Breast Care



Highlights

syngo.Breast Care is the advanced reading and reporting solution with powerful tools for efficient screening and comprehensive multimodality diagnostics.

- Choose the most suitable solution from a stand-alone workstation to a multiple-user server
- Customize your automated reading workflow to your personal preferences
- Easily include multimodality and 3D ultrasound reading, synthetic views, contrast enhanced mammography, breast density and CAD information
- Integrated CAD solutions with interactive decision support based on highly trained AI-based algorithms

Artificial Intelligence

Hologic · 3DQuorum SmartSlices



Highlights

The highest resolution 3D imaging, now with a faster read time.

3DQuorum technology utilises Genius AI-powered analytics to uniquely reconstruct high-resolution 3D Mammography data to produce 6mm SmartSlices. These speed up reading time by reducing the number of images to review, with no compromise in image quality, sensitivity or accuracy.<sup>2,3</sup> Accelerate detection with our newest innovation reducing your read times by an hour a day.<sup>1,2</sup>

<sup>1</sup> Data on File: Clinical Study Report CSR-00116  
<sup>2</sup> MAN-06153. Dimensions Breast Tomo.  
<sup>3</sup> MAN-06029. 3DQuorum.

Hologic · Genius AI Detection\*



Highlights

Genius AI Detection technology using deep learning algorithm to help find more cancers in both Hologic tomo images.<sup>1</sup> Integrated on the acquisition workstation, offers real-time results at the POC offering unique workflow opportunities that can be used to prioritise high risk cases and shorten the patient journey. It supports also the 3DQuorum and Synthesised 2D images and will continue to evolve with Hologic's imaging technology.

\* Not CE marked. Not available for sale. Not for distribution. CE Mark expected in April  
<sup>1</sup> Hologic data on file: DHM-10095

ScreenPoint Medical · Transpara

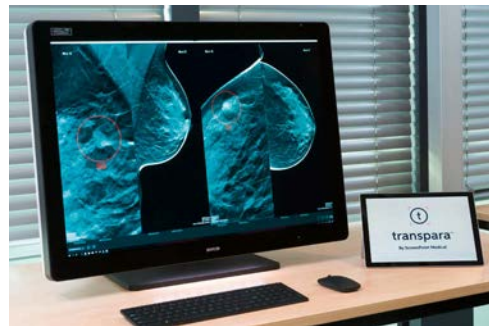

Highlights

ScreenPoint Medical is the leading developer of AI driven image analysis technology for automated reading of 2D and 3D mammograms. Transpara is in clinical use in over 30 countries and is the most advanced commercially available multivendor AI solution (CE marked and FDA cleared for 2D and 3D). Find us at ECR 2022 or visit <https://www.screenpoint-medical.com>

Accessories / Complementary Systems

Hologic · LOCalizer wire-free guidance system



**Highlights**

The LOCalizer wire-free guidance system is designed to guide breast surgeries easily and precisely. Instead of using wires or radioactivity, the LOCalizer™ system marks the lesion with a miniature radio frequency Tag that is tracked with a mobile handheld Reader. The RFID Tag is designed to be implanted into the breast any time prior to surgery. The handheld displays the distance from the Tag in millimeters and the unique ID number, ensuring that this is the intended, marked spot.

I.A.E. · C340



**Highlights**

- Water cooled mammography tube unit for beam scanning mammography equipments, high patients throughput screening applications
- Brass body lead free X-ray shielding internal pump for oil circulation improves oil to casing thermal Exchange
- Water cooled jacket avoids remote oil circulation
- Compact lightweight structure
- 800 W continuous dissipation for high energy techniques, high patients throughput

I.A.E. · XK1016T- 400W



**Highlights**

- Rotating anode mammography X-ray tube, with special bi-angled target, for optimal performances with all techniques
- Two separate focal tracks, small focus on 10° and large focus on 16°, optimal resolution performances
- Reduced thermal stress on the bearings improves tube life duration
- Severe tests during conditioning assure best performances
- Compact light weight structure

PTW · Normi MAM – Digital X-Ray Test Object

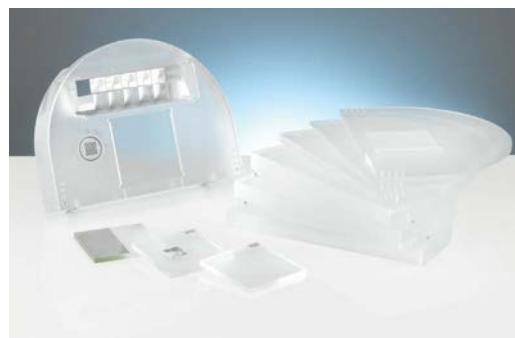

**Highlights**

- Checks all relevant parameters of digital mammographic X-ray installations
- Fully complies with DIN 6868-162 and DIN 6868-14
- Modularly composed test object
- Incl. different absorbers and test elements

# R / F Systems

DR  
Bucky  
DR Detectors  
CR  
Flatpanel Fluoro  
Fluoroscopy  
Mobile DR  
Portable DR  
Mobile X-ray  
DXA  
Business Intelligence  
Accessories

**AGFA**   
HealthCare

 ARCOMA

**Canon**  
CANON ELECTRON TUBES & DEVICES CO., LTD.

**Canon**



KONICA MINOLTA

**DK**  Medical Systems

**DRGEM**  
*Your Best Healthcare*

**EXAMION**<sup>®</sup>  
X-Ray Systems · Digital Imaging · Service

**FUJIFILM**



GMM

**HOLOGIC**<sup>®</sup>  
 The Science of Sure





**mindray**



 OR Technology

**PTW** THE DOSIMETRY COMPANY

**DEL MEDICAL**

 **SHIMADZU**  
Excellence in Science

**SIEMENS**  
Healthineers

 Solutions for tomorrow

 **STEPHANIX**  
MEDICAL IMAGING SOLUTIONS

**SWISSRAY**   
TECHNOLOGIES

**STERNMED**<sup>®</sup>  
*we make it possible*

 **TECHNIX**



DR

**Agfa · DR 600 (Ceiling Suspended)**

<b>Power</b> 40 / 50 / 65 / 80 kW	<b>Detector type</b> Csl / GOS	<b>Pixel size</b> <150 µm
--------------------------------------	-----------------------------------	------------------------------

**Highlights**

- Intelligent, high productivity, fully automated DR system
- Agfa's SmartXR features lighten the workload and provides a helping hand for fast, smooth image acquisition
- Excellent user-friendly 10 inch tube head display with preview image
- Detector Csl technology with dose reduction potential
- Tilting wallstand bucky with vertical tracking, holders for patient convenience and collimator light switch
- High-productivity, top-of-the-line, direct radiography system with motorized auto-positioning.



- "Musica processing" provides superior contrast detail and consistent, exam independent image quality
- Automatic versions support DR detectors in the wall stand and table with optional additional integrated CR
- Digital Tomosynthesis

**Agfa · DR 400 (Floormounted)**

<b>Power</b> 40 / 50 / 65 / 80 kW	<b>Detector type</b> Csl / GOS	<b>Pixel size</b> <150 µm
--------------------------------------	-----------------------------------	------------------------------

**Highlights**

- Cassette size bucky can rotate from landscape to portrait
- Build-in Dose Area product meter (optional)
- Scalable, flexible and affordable modality
- Flexible configurations and options for most needs
- Supports CR and DR integration
- Requires limited space (4x2 m)
- "Musica processing" provides superior contrast detail and consistent, exam-independent image quality
- "Musica acquisition station" offers comprehensive functionality for integrated workflow



**Agfa · DX-D 300**

<b>Power</b> 50 / 65 / 80 kW	<b>Detector type</b> Csl / GOS	<b>Pixel size</b> <150 µm
---------------------------------	-----------------------------------	------------------------------

**Highlights**

- Universal modality
- Single DR detector
- "Musica processing" provides superior contrast detail and consistent, exam-independent image quality
- "Musica acquisition station" offers comprehensive functionality for integrated workflow
- Integrated software for generator and positioner interface



- Complete versatility with optional CR / DR combination
- Motorized positioner
- Floor mounted

**Agfa · Valory**

<b>Power</b> 40 / 50 / 65 / 80 kW	<b>Detector type</b> Csl	<b>Pixel size</b> <150 µm
--------------------------------------	-----------------------------	------------------------------

**Highlights**

- Digital Radiography room with a simple design that goes beyond the basics
- Proven reliability
- For maximised productivity
- Modular design for every budget
- Removable grids and Dura line wireless detectors
- First time right images
- Musica image quality



**Arcoma · Precision i5 – Powered by Canon DR**

<b>Power</b> 50 / 65 / 80 kW	<b>Detector type</b> Csl	<b>Pixel size</b> 125 µm
---------------------------------	-----------------------------	-----------------------------

**Highlights**

Premium digital X-ray system for all radiographic applications

- Superior workflow for high volume patient throughput
- Auto positioning
- Motorized wall stand with motorized tilt of the detector
- OTC display with modern user interface and integrated light indication
- High capacity examination table
- Easy manual fine-tuning of the overhead tube
- Fully automatic image stitching



**Arcoma · Intuition – Powered by Canon DR**

<b>Power</b> 50 / 65 / 80 kW	<b>Detector type</b> Csl	<b>Pixel size</b> 125 µm
---------------------------------	-----------------------------	-----------------------------

**Highlights**

Versatile solution for all radiographic applications

- Optimized workflow for high volume patient throughput
- Easy manual fine-tuning of the overhead tube
- Motorized Z-movement for easy positioning
- Easy to fit in low ceiling X-ray rooms
- High capacity examination table
- User interface with easy access to information





DR

**Canon · Adora DRi**

<b>Power</b> 65 kW	<b>Detector type</b> Csl	<b>Pixel size</b> 125 µm
-----------------------	-----------------------------	-----------------------------



**Highlights**  
Next generation high-end DR solution for all radiographic applications

- Intelligent workflows for high volume patient throughput
- APR auto-positioning with up to 999 positions
- Lateral examinations without repositioning of the patient
- Motorized manual handling using SmartHandle joystick

- Intuitive, icon-based user controls at the tube head
- State-of-the-art ergonomics
- Table: Motorized, carbon fiber, floating top with 340° rotation

**Canon · Aceso+**

<b>Power</b> 50/65/80 kW	<b>Detector type</b> Csl	<b>Pixel size</b> 125 µm
-----------------------------	-----------------------------	-----------------------------



**Highlights**  
Aceso+ represents the optimum combination of 4th generation auto-positioning technology with ergonomic design. The result is an advanced digital radiographic system that creates an efficient workflow and maximizes patient throughput. Featuring advanced applications like auto-stitching, Aceso+ is the optimal solution to all your imaging needs.

**Canon · Aceso**

<b>Power</b> 50/65/80 kW	<b>Detector type</b> Csl	<b>Pixel size</b> 125 µm
-----------------------------	-----------------------------	-----------------------------



**Highlights**  
The Aceso is a unique combination of proven technology that creates an elite, yet cost-effective, DR imaging solution to a wide variety of clinical needs. The Aceso can be installed in both the tallest and shortest of rooms. Our unique ceiling wagon provides unsurpassed usable stroke for high ceiling heights while the CUBE solution allows the system to be installed in rooms with ceilings as low as 2.5 m without requiring ceiling support infrastructure.

**Canon · Easy DR**

<b>Power</b> 50/65/80 kW	<b>Detector type</b> Csl	<b>Pixel size</b> 125 µm
-----------------------------	-----------------------------	-----------------------------



**Highlights**  
Versatile solution for multipurpose examinations

- Multipurpose floor mounted X-ray system
- Suitable for mobile installations (i. e. truck or container)
- Retractable anti-scatter grid
- Vertical and horizontal positioning of the U-arm
- Acquisition station with DICOM calibrated touch screen display
- Asymmetrical diaphragm, specially designed for thorax examinations
- Optional low-power consumption X-ray Generator

**Canon · Trauma DR Plus**

<b>Power</b> 50/65/80 kW	<b>Detector type</b> Csl	<b>Pixel size</b> 125 µm
-----------------------------	-----------------------------	-----------------------------



**Highlights**  
Versatile solution for trauma applications

- Fast and efficient workflow
- Easy manual positioning with motorized support for Z-movement
- Large open workspace with a fixed focus-detector distance of 135 cm
- Integrated cable management

- C-Arm dept of 55 cm
- Integrated Dose Area Product Meter (DAP)
- Acquisition station with large DICOM calibrated touch screen display

**Canon · Radrex**

<b>Power</b> 50/80 kW	<b>Detector type</b> Csl	<b>Pixel size</b> 125 µm
--------------------------	-----------------------------	-----------------------------



**Highlights**  
Canon Medical's cost-effective Radrex digital radiography systems provide clinical efficiency to meet your radiographic imaging demands today and into the future. Fitted with Canon's high-quality flat panel detectors and its imaging and patient management software, Radrex provides outstanding versatility, high patient comfort and superior workflow for your facility.

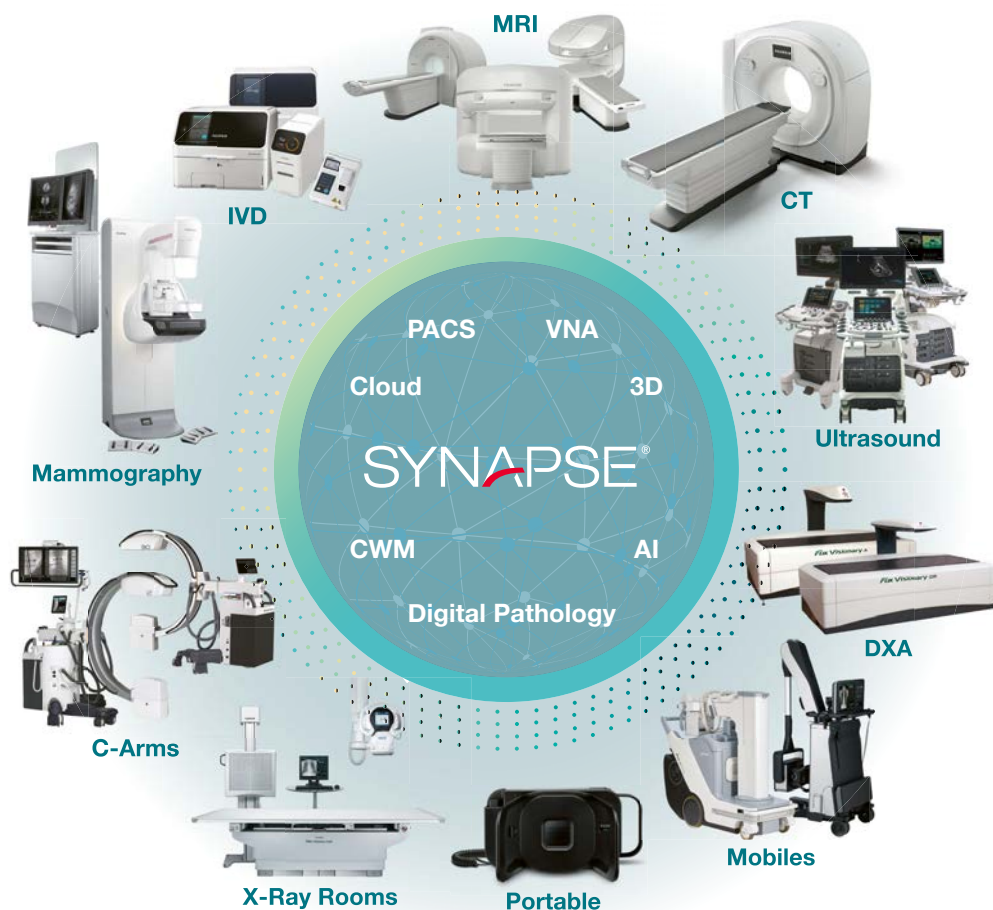

## Fujifilm “ONE-STOP” solution partner for the healthcare systems

Fujifilm began its medical business with the production of X-ray film in 1936, exactly two years after its foundation, and began a path of transformation that has always characterised its industrial history, before succeeding in digitising X-ray images for the first time in the world in 1981. And again in 1999, in the wake of the digitisation explosion, Fujifilm launched Synapse, the world's first fully web-based image storage and communication system. Since then, the company has refined its image processing technology and added value by integrating it with information technology and artificial intelligence.

Today, Fujifilm has a wide range of products including diagnostic X-ray imaging equipment, ultrasound systems, endoscopy, in vitro diagnostics, CT, MRI, and by positioning medical informatics as an open platform, the company can offer a wide variety of solutions to healthcare systems.

The recent acquisition of Hitachi's diagnostic imaging business, which was completed in 2021, and the incorporation of Hitachi's imaging business into the new Fujifilm Healthcare company has generated a powerful new force in medical imaging and plays a strategic role in Fujifilm's plan to become a more comprehensive healthcare company capable of providing highly customized and advanced solutions.

More concretely, with the addition of CT, MRI, ultrasound and other technologies, the company will be able to create an even broader product line-up than ever before. Combining the products and professionals of both companies will strengthen the collective ability to positively impact healthcare. In addition, this acquisition allows the company to gain a competitive advantage in the medical device market by leveraging the sales and distribution channels of Fujifilm and Fujifilm Healthcare.

Fujifilm today aims to become an entity that can contribute to the advancement of human health by supporting the ongoing transformation in the healthcare industry, shifting the focus from a "passive" to a "proactive" model of medicine: from "treatment after serious illness" to "prevention, early detection and timely treatment" for various diseases, including cancer.

But mostly Fujifilm will support the transformation of the healthcare sector by contributing to the improvement of human health and positioning as “ONE-STOP” solution partners.



DR

**Del Medical · FMT**

Power	Detector type	Pixel size
32/40/50/65/80 kW	GOS / Csl	140/148 μm



**Highlights**

- Compact and economical floor-mounted tube stand with low ceiling requirement of just 2.2 meters
- Technologist friendly digital display of SID and tube angle
- Easily accessible tube mounted lock release for 180° column rotation
- High quality table with four-way floating tabletop and 318 kg patient weight limit
- Space efficient wallstand for wireless detectors with 148 cm of vertical travel

**Del Medical · FMT18M**

Power	Detector type	Pixel size
32/40/50/65/80 kW	GOS / Csl	140/148 μm



**Highlights**

- Tube lock control for 180° column rotation
- 10.4-inch tube mounted touch-screen interface for generator control, detector selection, SID and tube angle display
- Ergonomic tube handle with all-lock release optical sensor
- Elevating table with four-way float and 363 kg patient weight limit with 6-way patient table with 363 kg patient weight limit.
- Premium wallstand with ergonomic handle and patient handgrips
- Optional rotating DR tray
- 43 × 108 / 43 × 43 / 35 × 43 / 24 × 30 cm detector

**Del Medical · FMT18T**

Power	Detector type	Pixel size
32/40/50/65/80 kW	GOS / Csl	140/148 μm



**Highlights**

- Easily positioned floor mounted tube stand for efficient workflow
- Vertical tracking to table and wall stand
- 10.4-inch tube mounted touchscreen interface for generator control, detector selection, SID and tube angle display
- Ergonomic tube handle with all-lock release optical sensor
- Elevating table with four-way float, table-top mounted controls and 363 kg patient weight limit
- Premium wallstand
- Optional rotating DR tray for 35 × 43 cm wireless flat panel detector

**Del Medical · FWFC**

Power	Detector type	Pixel size
32/40/50/65/80 kW	GOS / Csl	140/148 μm



**Highlights**

- Affordable solution for medical imaging centers and urgent care facilities
- Digital display of SID and tube angle
- Easy installation - floor to wall or floor to ceiling tube tracks
- Pressure activated 180° column rotation
- High quality table with four-way floating tabletop and 318 kg patient weight limit
- Space efficient wallstand for wireless detectors with 148 cm of vertical travel

**Del Medical · OTC18M**

Power	Detector type	Pixel size
32/40/50/65/80 kW	GOS / Csl	140/148 μm



**Highlights**

- Ceiling mounted tube crane with lightweight and precise manual positioning
- 10.4-inch tube mounted touch-screen interface for generator control, detector selection, SID and tube angle display
- Five-tier telescoping column with 180 cm reach for head-to-toe imaging
- Ergonomic tube handle with all-lock release optical sensor
- 6-way patient table with 363 kg weight limit
- Premium wallstand with tilting option
- 43 × 108 / 43 × 43 / 35 × 43 / 24 × 30 cm detector

**Del Medical · OTC18S**

Power	Detector type	Pixel size
40/50/65/80 kW	GOS / Csl	148 μm



**Highlights**

- Ceiling mounted tube crane with automated tube rotation for motorized stitching functionality
- Elevating table with 4-way float, motorized auto-tracking receptor, and 363 kg patient weight limit
- Premium tilting wallstand with motorized auto-tracking receptor
- 10.4-inch tube mounted touchscreen interface for system control and stitching set up
- DELWORKS digital radiography with choice of 43 × 43 cm or 35 × 43 cm detectors

DR

**Del Medical · OTC18T**

Power	Detector type	Pixel size
32/40/50/65/80 kW	GOS / Csl	140/148 μm



**Highlights**

- Ceiling mounted tube crane with lightweight and precise manual positioning
- Vertical tracking to table and wall stand
- Ergonomic tube handle with all-lock release optical sensor
- 10.4-inch tube mounted touch-screen interface for generator control, detector selection, SID and tube angle display
- 6-way patient table with 363 kg patient weight limit

- Premium wallstand with tilting option
- 43 × 108 / 43 × 43 / 35 × 43 / 24 × 30 cm detector

**Del Medical · Straight Arm**

Power	Detector type	Pixel size
32/40/50/65/80 kW	GOS / Csl	148 μm



**Highlights**

- Economical and space-efficient X-ray system perfect for Ambulatory Clinics, Imaging Centers or Urgent Care facilities
- Efficient isocentered design keeping the detector and X-ray beam in constant alignment
- Flexible movement with extensive range of arm and image receptor rotation
- Motorized variable SID adjustment of 100 to 200 cm
- Extensive vertical travel 42 to 163 cm
- Optional mobile patient table for recumbent exams
- Choice of fixed or wireless flat panel detector

**DK Medical · Innovision-DXII (Ceiling Type, ELIN-T3 Plus)**

Power	Detector type	Pixel size
50 kW	Csl / GoS	140 μm



**Highlights**

- Manual ceiling systems
- Ceiling-mounted tube support
- Motorized up and down movement (Option)
- Open type 2 column table (Easy to position for wheelchair patient)

**DK Medical · Innovision-DXII (Ceiling Type, ELIN-T4)**

Power	Detector type	Pixel size
50 kW	Csl / GoS	140 μm



**Highlights**

- Synchronized with tube support and bucky stand
- Ergonomic design for smooth movements and optimized workflow
- Intuitive direction movement indicator and user-friendly interface
- Convenient stitching for whole-spine and Long-bone.
- Open type 2 column table (Easy to position for wheelchair patient)

**DK Medical · Innovision-DXII (Floor Type)**

Power	Detector type	Pixel size
50 kW	Csl / GoS	140 μm



**Highlights**

- High-frequency inverter type generator
- Easy operation with floor-mounted tube support (Stand-alone type is optional)
- Open type 2 column table (Easy to position for wheelchair patient)
- User convenience with APR

**DK Medical · Innovision-EXII (Ceiling Type, ELIN-T5)**

Power	Detector type	Pixel size
50/80 kW	Csl / GoS	140 μm



**Highlights**

- Premium ceiling system for high-end market
- Excellent image quality and superb dose efficiency
- Fully automatic image stitching (Convenient stitching for whole-spine and long-bone)
- Fast and efficient workflow
- LCD UI

DR

**DK Medical · Innovision-DXII (3-in-1 Type)**

Power	Detector type	Pixel size
50 kW	CsI/GoS	140 μm



**Highlights**

- Efficient space utilization
- Combined system consisting of tube support, table and generator (space saving)
- Bucky tray following in same direction with tube stand movement
- Collimator turning on automatically
- User convenience with APR
- Standing knee position (Enables users to take images more conveniently without any hopital tool.

**DRGEM · Essential Ceiling System (GXR-SD Series)**

Power	Detector type	Pixel size
32/40/52/68/82 kW	GOS/CsI	—



**Highlights**

- System concept: Highly customizable DR ceiling system
- Fundamental solution at affordable price
- Ergonomic design for smooth movements and optimized workflow
- Intuitive direction movement indicator and user-friendly interface
- Elevating or floating table with high patient load up to 300 kg
- Integrated lock function
- Options include AEC, carbon tabletop, dual speed rotor, built-in charging option for detector & premium upgrade
- Optional AI Software available
- Detector format: 17×17" / 17×14" wired/wireless

**DRGEM · Floor Mounted System (GXR-SD Series)**

Power	Detector type	Pixel size
32/40/52/68/82 kW	GOS/CsI	—



**Highlights**

- System concept: Premium floor mounted system
- Highly customizable digital diagnostic radiography system
- Auto-synchronization and auto-bucky tracking function
- Tube stand touch screen console for system, collimator, X-Ray control and X-ray preview
- Elevating or floating table
- Options include AEC, carbon tabletop, dual speed rotor, built-in charging option for detector & premium upgrade
- Optional AI software available
- Detector format: 17×17" / 17×14", wired/wireless

**DRGEM · Auto Positioning Ceiling System (GXR-SD Series)**

Power	Detector type	Pixel size
52/68/82 kW	GOS/CsI	—



**Highlights**

- System concept: premium ceiling system for high-end market
- Higher accuracy through fully integrated system
- High efficiency with optimized workflow
- Patient safety with various sensors
- Multiple image stitching for stand and table
- Advanced elevating table with high patient load up to 300 kg
- Tube stand touch screen console for system, collimator, X-ray control and X-ray preview
- Collimator live streaming camera
- Options include AEC, carbon tabletop, built-in charging option for detector
- Optional AI software available
- Detector format: 17×17" / 17×14", wired/wireless

**DRGEM · Compact System (GXR-ES Series)**

Power	Detector type	Pixel size
20/25/32/40 kW	GOS/CsI	—



**Highlights**

- System concept: fit for your space, workflow and budget
- Compact size (minimum floor space: 2.7 × 1.8 m)
- Designed for optimized workflow and smooth movements (Bucky auto tracking, wall stand counter balance)
- Intuitive movement direction indicator
- Highly customizable (wall stand and tube stand options are available)
- Tabletop with patient load up to 300 kg (optional acrylic tabletop)
- Integrated lock function
- Optional AI software available
- Detector format: 17×17", wireless/portable

**DRGEM · Diamond (U-Arm Type)**

Power	Detector type	Pixel size
52/68/82 kW	GOS/CsI	—



**Highlights**

- System concept: all-in-one digital radiography system
- Fully automatic digital radiography system
- High-resolution removable detectors and grids
- Touch screen controller at system
- Mobile patient table, remote control
- Automatic X-ray collimation and system positioning
- Safety sensors / AEC
- Optional AI software available
- Detector format: 17×17", wired/wireless

DR

**DRGEM · DR System for Chest and Chiropractic**

<b>Power</b> 32/40/52 kW	<b>Detector type</b> GOS/ CsI	<b>Pixel size</b> —
-----------------------------	----------------------------------	------------------------

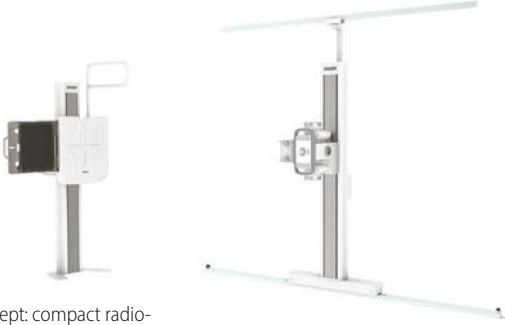

**Highlights**

- System concept: compact radiography system for clinic
- Motorized vertical synchronization with wallstand
- Image stitching for whole body
- Vertical synchronization tube with bucky
- UPS or capacitor generator is recommended
- Optional AI software available
- Detector format: 17×17" / 17×14", wired/wireless

**DRGEM · Veterinary Compact System (VXR-E/EC Series)**

<b>Powerful system</b> 20/25/32/40 kW	<b>Detector type</b> CsI, 17×17" / 17×14", wired/wireless	<b>Pixel size</b> —
--	--	------------------------



**Highlights**

- Compact & powerful system
- Space-efficient hardware
- Powerful imaging S/W
- Capacitor generator available
- Intuitive touch screen control console and monitor
- Animal positioning guide
- Easy cleaning with moving caster and urine trap
- Various table size options to match customer need

**Examion · X-DRS Ceiling**

<b>Power</b> 55/65/80 kW	<b>Detector type</b> a-Si/ CsI	<b>Pixel size</b> 100 – 150 µm
-----------------------------	-----------------------------------	-----------------------------------



**Highlights**

The Examion ceiling-suspended X-ray systems meet all hospital's requirements.

- Detector size: 10 × 12" – 17 × 17"
- High quality images
- Well proven system
- Motorized tube support
- Low maintenance effort
- Affordable price
- Up to four detectors
- Option: Stitching, Autopositioning

**Examion · X-DRS Floor Basic**

<b>Power</b> 50/65/80 kW	<b>Detector type</b> a-Si/ CsI	<b>Pixel size</b> 100 – 150 µm
-----------------------------	-----------------------------------	-----------------------------------



**Highlights**

The floor mounted systems can be optimally adapted to the needs of the customer:

- Detector size: 10 × 12" – 17 × 17"
- High image quality
- Variant with purely mechanical movements
- Low maintenance effort
- Affordable price

**Examion · X-DRS Floor Standard (E)**

<b>Power</b> 50/65/80 kW	<b>Detector type</b> a-Si/ CsI	<b>Pixel size</b> 100 – 150 µm
-----------------------------	-----------------------------------	-----------------------------------



**Highlights**

The X-DRS Floor Standard (E) is especially suitable for use in large medical practices, healthcare centres and small hospitals.

- Modern design
- Bucky tray on the table and on the wallstand are electromotively synchronised with the X-ray tube
- Intuitive handling via the Examion X-AQS control console

**Examion · X-DRS Floor Z-Arm or U-Arm**

<b>Power</b> 50/65/80 kW	<b>Detector type</b> a-Si/ CsI	<b>Pixel size</b> 100 – 139 µm
-----------------------------	-----------------------------------	-----------------------------------



**Highlights**

The U-Arm and Z-Arm systems are compact and space-saving X-ray machines.

- Detector size: 17 × 17"
- Ideal for small rooms and low ceiling heights
- Easy positioning due to direct coupling of detector and tube
- Low maintenance effort
- Affordable price

DR

**Fujifilm · FDR Smart X**

Power	Detector type	Pixel size
32 / 40 / 52 / 68 / 82 kW	CsI / GOS	150 µm

**Highlights**

- FDR Smart X series, Fujifilm's multi-function, high quality, cost-effective X-ray solutions.
- Ceiling suspended configurations with or without Auto-positioning and floor mounted X-ray options.
- Easy positioning workflow with synchronization of X-ray tube and radiography stand/table.
- Integration of Console Advance and generator control console in a single PC, allows fully streamlined operation in a single GUI.
- Capacitor, UPS and Line powered



generator configurations solutions for all environments.

- Compatible with FDR D-EVO series GOS and cSI detectors, 43 × 43cm, 35 × 43cm and 24 × 30 cm.

**GMM Group · Calypso F – Multifunctional DR system**

Power	Detector type	Pixel size
50 kW – 80 kW	a-Si	139 µm – 148 µm

**Highlights**

- Advanced DR system with a full range of floor-based configurations
- Touchscreen to control system movements and functions
- Reduced footprint for the smallest and low ceiling height rooms
- Perfect synchronization between detector and X-ray tube movements, also for stitching procedures
- Advanced GMM Imaging System for high image quality
- Suited to paediatric needs thanks to dose reduction



**GMM Group · Calypso – Multifunctional DR system**

Power	Detector type	Pixel size
50 kW – 80 kW	a-Si	139 µm – 148 µm

**Highlights**

- Flexible and configurable DR ceiling system
- Auto-positioning and auto-tracking functions to enable preset system positions
- Stitching function for long skeletal segments reconstruction, both in vertical and horizontal direction
- Friendly interface and fast workflow with the innovative GMM Imaging System



- Low delivered dose, further reduced while operating in direct contact with the detector

**GMM Group · Kalos – DR system**

Power	Detector type	Pixel size
65 – 80 kW	a-Si	125 µm

**Highlights**

- Elevating table with detector floating in both longitudinal and lateral directions
- Auto-positioning and auto-tracking functions to enable programmed positions
- Patented Autofocusing Grid for an optimal focalization
- State-of-the-art Canon imaging software and detectors
- Advanced image processing to further reduce dose and enhance anatomical details
- Horizontal and vertical stitching procedures



**GMM · Kalos – Powered by Canon DR**

Power	Detector type	Pixel size
65 / 80 kW	CsI	125 µm

**Highlights**

Next generation high end DR solution for all radiographic applications

- Optimized for high volume patient throughput
- Widely larger tabletop and 4-ways movable bucky to avoid patient re-positioning
- More than 350 different preset automatic positions
- Smart auto tracking, available also for lateral projections with the table
- Automatic full spine and lower extremities reconstruction
- Patented autofocusing anti-scatter grid



Powered by Canon DR

- Remote control for motorized movements
- Integrated with Canon detectors
- Canon NE acquisition software with generator integration

**Intermedical · Submarine – DR System**

Power	Detector type	Size
65 / 80 kW	fixed / portable, single / double	36 × 43 cm w/fi, 43 × 43 cm fixed

**Highlights**

A highly integrated system ensuring high quality diagnostic results in traumatology, emergency, routine and specialized examinations.

- Easy APP auto-positioning
- Detector tracking in all directions
- Fully automatic image stitching
- Generator power up to 80 kW
- DELUXE processing provides outstanding image quality
- Fast and efficient workflow
- Full DICOM



DR

**Konica Minolta · AeroDR X90**

Power	Detector type	Pixel size
65 – 80 kW	CsI	100 µm



**Highlights**

- Premium digital X-ray system
- Auto-positioning, auto-tracking and auto-stitching
- Interactive tube head display
- Excellent workflow in combination with AeroDR detector
- Soft handling of OTC with a light touch
- Best image quality, low dose
- Detector size: 14 × 17" / 17 × 17" / 10 × 12"
- Intuitive and user friendly AeroNAV console

**Konica Minolta · AeroDR X60**

Power	Detector type	Pixel size
65 – 80 kW	CsI	100 µm



**Highlights**

- Premium motorized digital X-ray system
- Auto-stitching for long leg and spine images
- Excellent workflow in combination with AeroDR detector
- Best image quality, low dose
- Detector size: 14 × 17" / 17 × 17" / 10 × 12"

**Mindray Medical · DigiEye 280 DR System**

Power	Detector type	Pixel size
30 kW / 50 kW / 65 kW	CsI	140 µm



**Highlights**

- High frequency generator >400kHz
- Integrated generator design to save installation space
- Multiple power choices: 30 kW, 50 kW, 65 kW
- Detector: CsI material, high DQE
- Detector size: 14 × 17" and 17 × 17"
- Connection: wired & wireless detectors

**NRT · Adora DRi – Powered by Canon DR**

Power	Detector type	Pixel size
65 kW	CsI	125 µm



**Highlights**

Next generation high-end DR solution for all radiographic applications

- Intelligent workflows for high volume patient throughput
- APR auto-positioning with up to 999 positions
- Lateral examinations without repositioning of the patient
- Motorized manual handling using SmartHandle joystick
- Intuitive, icon-based user controls at the tube head
- State-of-the-art ergonomics
- Table: Motorized, carbon fiber, floating top with 340° rotation

**OR Technology · Amadeo Z-DR motorised**

Power	Detector type	Pixel size
50 – 80 kW	CsI	100/139/140/154 µm



**Highlights**

The fully motorised swing-arm X-ray system is perfect for all adjustment techniques as well as automated whole spine and whole leg imaging (stitching). Images of the patient can be taken sitting, standing or lying down. The arm swivels fully automatically over a range of motion of 150°, rotates around the patient and thus facilitates the entire procedure enormously. Five electric motors allow effortless and accurate positioning of the stand.

**OR Technology · Amadeo R-DR motorised**

Power	Detector type	Pixel size
50 – 80 kW	CsI	100/120/139/140/154 µm



**Highlights**

The Amadeo R-DR is a universal X-ray system with bucky table and wallstand. The compact design of Amadeo R-DR allows installation in tight spaces. Simple operation and handling ensure fast training of the X-ray staff. The X-ray source and the bucky cabinet of the wall stand are designed so that they can be folded down to the floor. The large floating table top has a high load carrying capacity. As an option, a shorter table can be used in tight spaces.



DR

**OR Technology · Amadeo S-DR motorised**

Power	Detector type	Pixel size
50– 80 kW	CsI	100/139/140/154 μm

**Highlights**

Due to its compact design and the minimum ceiling height of only 2.4 m, the motorised U-arm X-ray system is especially designed for small rooms. The very flexible and partly motorised positioning of the stand allows a wide range of images to be taken. All important settings and operating procedures are made on the integrated 10" touch display. Both, the bucky tray and the tube can be rotated and thus allow very variable X-ray settings. All necessary device positions can be pre-defined on the 60 available program positions.



**Shimadzu · RADspeed Pro DR**

Power	Detector type	Pixel size
50/ 65/ 80 kW	CsI	100/125/ 175 μm

**Highlights**

- Tube support with new Power Glide technology
- Flexible choice of different flat panel detectors
- Excellent image quality
- Five axis auto-positioning function
- Speed stitch function
- Superb dose efficiency
- Seamless network integration
- Size: 17 × 17" (43 × 42 cm)
- 14 × 17" (35 × 43 cm)
- 14 × 11" (35 × 27 cm)
- 12 × 10" (30 × 25 cm)



**Shimadzu · RADspeed Pro Edge**

Power	Detector type	Pixel size
50/ 65/ 80 kW	CsI/ GOS	150 μm

**Highlights**

- High-performance digital radiographic system with extended functionality
- Tomosynthesis (Digital multi-slice tomography)
- Auto-stitching (Speed stitch function)
- Dual energy subtraction
- Auto-positioning
- Innovative flat panel detectors for increased versatility
- Low dose collimator with auto-filtering feature
- Size: 43 × 43 cm, 43 × 35 cm, 30 × 24 cm



radiology ahead

armonicus



compact fast global

DR

**Siemens Healthineers · Multitom Rax**

<b>Power</b> 65 / 80 kW	<b>Detector type</b> a-Si / CsI	<b>Pixel size</b> 148 μm
----------------------------	------------------------------------	-----------------------------



**Highlights**

- The worlds first twin robotic X-ray scanner
- Set new standards in advanced musculoskeletal and trauma imaging
- Optional with Real3D and True2scale imaging
- Precise insights through unique automation
- Efficient workflows around your patients
- Comprehensive diagnoses with multiple procedures
- Unlock the potential of your X-ray department with Fleet Level Benefits
- Detector size:  
43 × 43 cm (RAX detector)  
35 × 43 cm (MAX wi-D)  
24 × 30 cm (MAX mini)

**Siemens Healthineers · Ysio X.pree**

<b>Power</b> 65 / 80 kW	<b>Detector type</b> a-Si / CsI	<b>Pixel size</b> 148 μm
----------------------------	------------------------------------	-----------------------------



**Highlights**

- User-assisting system intelligence for X-ray examinations
- Unique automation for fast, simple, and safe positioning
- 3D camera for patient positioning and advanced collimation
- Smart imaging concept for an excellent level of consistency
- Unlock the potential of your X-ray department with Fleet Level Benefits
- Detector size:  
43 × 43 cm (MAX static)  
35 × 43 cm (MAX wi-D)  
24 × 30 cm (MAX mini)

**Siemens Healthineers · Ysio Max**

<b>Power</b> 65 / 80 kW	<b>Detector type</b> a-Si / CsI	<b>Pixel size</b> 148 μm
----------------------------	------------------------------------	-----------------------------



**Highlights**

- Streamline workflows with full automation for fast, simple, and safe positioning
- Standardize outcomes to obtain consistently high image quality for all patients
- Unlock the potential of your X-ray department with Fleet Level Benefits
- Tailor the modular system to precisely meet your requirements
- Detector size:  
43 × 43 cm (MAX detector)  
35 × 43 cm (MAX wi-D)  
24 × 30 cm (MAX mini)

**Siemens Healthineers · Multix Impact C**

<b>Power</b> 55 / 65 / 80 kW	<b>Detector type</b> a-Si / CsI	<b>Pixel size</b> 148 μm / 139 μm
---------------------------------	------------------------------------	--------------------------------------



**Highlights**

- Ceiling-mounted radiography with myExam Companion
- High-end technology at an economical price, to improve access to care
- User-assisting system intelligence for X-ray examinations
- Intuitive imaging software and positioning guide, and optional motorization and tracking functions
- Unlock the potential of your X-ray department with Fleet Level Benefits
- Detector size:  
43 × 43 cm (MAX detector)  
35 × 43 cm (MAX wi-D)  
24 × 30 cm (MAX mini)

**Siemens Healthineers · Multix Impact**

<b>Power</b> 55 / 65 / 80 kW	<b>Detector type</b> a-Si / CsI	<b>Pixel size</b> 148 μm / 139 μm
---------------------------------	------------------------------------	--------------------------------------



**Highlights**

- Floor-mounted radiography with myExam Companion
- High-end technology at an economical price, to improve access to care
- User-assisting system intelligence for X-ray examinations
- Intuitive imaging software and positioning guide, and full-motorization with SmartMove and detector tracking functions
- Unlock the potential of your X-ray department with Fleet Level Benefits
- Detector size:  
43 × 43 cm (Core static)  
43 × 43 cm (Core XL)  
35 × 43 cm (MAX wi-D)

**Stephanix · RAD rooms range**

<b>Power</b> Up to 80 kW	<b>Detector type</b> Fixed or wireless	<b>Pixel size</b> 125 μm / 148 μm
-----------------------------	---	--------------------------------------

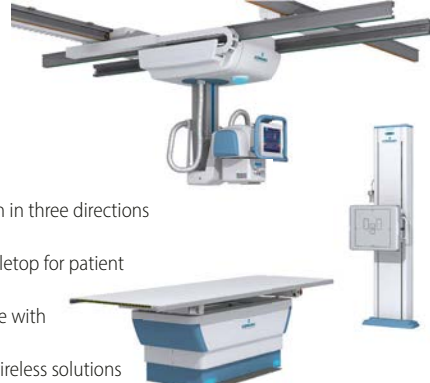

**Highlights**

- Autopositioning
- Motorized suspension in three directions
- Tilting wall bucky
- Elevating floating tabletop for patient weight up to 350 kg
- Intuitive user interface with unlimited preset APR
- Detector: fixed and wireless solutions
- Single or multi-detectors room
- Possibility to share wireless detectors with different Stephanix modalities
- Based on sensitive technology for effortless handling

DR

**Stephanix · Xtreme DReam**

<b>Power</b> Up to 80 kW	<b>Detector type</b> Fixed or wireless	<b>Pixel size</b> 125 µm / 148 µm
-----------------------------	---	--------------------------------------



**Highlights**

- Manual, vertical tracking or autopositioning version
- Single or multi-detectors room
- Fixed or tilting wall bucky
- Floating elevating tabletop for patient weight up to 300 kg
- Intuitive user interface with unlimited preset APR
- Possibility to share wireless detectors with different Stephanix modalities

- Detector: Fixed and wireless solutions
- Up to three Flat Panel Detectors, indirect conversion

**Stephanix · RAD Series Pro DReam**

<b>Power</b> Up to 80 kW	<b>Detector type</b> Fixed or wireless	<b>Pixel size</b> 125 µm / 148 µm
-----------------------------	---	--------------------------------------



**Highlights**

- Manual or vertical tracking version
- Single or multi-detectors room
- Fixed or tilting wall bucky
- Floating elevating tabletop for patient weight up to 300 kg
- Intuitive user interface with unlimited preset APR

- Possibility to share wireless detectors with different Stephanix modalities
- Detector: Fixed and wireless solutions
- Up to three Flat Panel Detectors, indirect conversion

**Stephanix · Statif Pro DReam**

<b>Power</b> Up to 80 kW	<b>Detector type</b> Fixed or wireless	<b>Pixel size</b> 125 µm / 148 µm
-----------------------------	---	--------------------------------------



**Highlights**

- Low footprint for wide range of procedures at standing, sitting or lying patient
- C-arm shaped for cross exams
- Autopositioning regarding each protocol
- Automatic and virtual collimation, additional filtration
- User-friendly interface

- Wireless remote
- Automatic positioning, collimation, filtration, parameters
- Table: Optional carbon or elevating tabletop, on wheels

**Stephanix · Statif DReam**

<b>Power</b> Up to 80 kW	<b>Detector type</b> Fixed or wireless	<b>Pixel size</b> 125 µm / 148 µm
-----------------------------	---	--------------------------------------



**Highlights**

- Multipurpose DR solution for small budgets
- It can be dedicated to chest and extremities examinations
- Low footprint for wide range of procedures at standing, sitting or lying patient
- Manual or motorized (SID and vertical movement)
- User-friendly interface
- Table: Optional carbon or elevating tabletop, on wheels

**Swissray · ddRAura U**

<b>Power</b> 50 / 65 / 80 kW	<b>Detector type</b> a-Si / CsI	<b>Pixel size</b> 148 / 139 µm
---------------------------------	------------------------------------	-----------------------------------



**Highlights**

- Automated Positioning System with unlimited APR programs
- Detector size: 43 × 43 cm
- Image display in 3 seconds
- 10.1" tube mounted touchscreen interface
- Single or dual detector options
- Off detector / Off center imaging

- Wireless handheld remote control or footswitch
- Small footprint
- Single focus stitching option

**Swissray · ddRAura S**

<b>Power</b> 50 / 65 / 80 kW	<b>Detector type</b> a-Si / CsI	<b>Pixel size</b> 148 / 139 µm
---------------------------------	------------------------------------	-----------------------------------



**Highlights**

- Multifunctional system for all radiography examinations
- Detector size: 43 × 43 cm
- Motorized height and SID adjustment
- Effortless manual rotation of straight-arm, detector and tube
- Perfect solution for high throughput chest screening programs
- Various generator power incl. battery assist

- Touch screen workstation with unlimited APR programs
- Multi language capability
- Robust design, maintenance friendly
- Fits into very small examination rooms

DR

**Villa Sistemi Medicali · Moviplan iC with Floor-mounted Column**

<b>Power</b> 50 / 65 / 80 kW	<b>Detector type</b> a-Si / CsI	<b>Pixel size</b> 100 µm / 143 µm
---------------------------------	------------------------------------	--------------------------------------



**Highlights**

- Innovative design with no unsightly cables
- Anti-collision system and reduced thickness rails
- Table commands with distinctive "light barrier"
- Touch screen interface integrated on tube-head for immediate inputs
- No patient limitation thanks to high weight capacity

- Electronic tomography with free selection of angle
- Available with stitching, auto-positioning, dual energy functions
- Detector size: 35 × 43 cm / 43 × 43 cm

**Villa Sistemi Medicali · Moviplan iC with Ceiling Suspension**

<b>Power</b> 50 / 65 / 80 kW	<b>Detector type</b> a-Si / CsI	<b>Pixel size</b> 100 µm / 143 µm
---------------------------------	------------------------------------	--------------------------------------



**Highlights**

- High-end solution allowing great application flexibility and high production capacity
- Touch screen interface integrated on tube-head
- Tilting chest stand with special horizontal positioning for exams on mobile stretchers
- Rapid and precise system positioning thanks to full auto-tracking and auto-positioning

- Available with stitching and dual energy functions
- Detector size: 35 × 43 cm / 43 × 43 cm

**Villa Sistemi Medicali · Armonicus**

<b>Power</b> 50 / 65 / 80 kW	<b>Detector type</b> a-Si / CsI	<b>Pixel size</b> 143 µm
---------------------------------	------------------------------------	-----------------------------



**Highlights**

- Compact and flexible U-arm design for extended use, including general radiographic, emergency and orthopedic studies.
- Configurable with integrated or wireless FPD and either with manual or automatic collimator
- Available with a wide choice of X-ray tubes and generators
- 10" touch Screen control panel and infrared remote control as standard
- Simplified user interface, with single movement functional push buttons
- A wide range of available and pre-programmable system's positions
- Operating with 2 grids, with

- dedicated grid parking
- Complete range of examinations allowed, including stitching procedure

**Examion · X-R Floor Z/U-Arm**

<b>Power</b> 50 / 65 / 80 kW	<b>Table</b> Different types available	<b>Table height</b> 59.5 – 86.5 cm
---------------------------------	---	---------------------------------------



**Highlights**

The U-Arm and Z-Arm systems are compact and space-saving X-ray machines.

- Ideal for small rooms and low ceiling heights
- Easy positioning due to direct coupling of detector and tube
- Low maintenance effort
- Affordable price

**GMM Group · Opera RT20 – RAD and TOMO Unit**

<b>Power</b> 32 kW – 80 kW	<b>Table</b> Floor mounted	<b>Table height</b> Adjustable
-------------------------------	-------------------------------	-----------------------------------



**Highlights**

- Compact X-ray units ensure application versatility and operational efficiency
- X-ray tube remarkable displacements for easy execution of examinations and oblique incidences also on stretchers
- Total safety and comfort for the patient and enhanced diagnostic results in examinations of the spine, thorax, legs, etc.
- Utmost user-friendliness also in combination with wallstands

**Shimadzu · RADspeed Pro Automatic**

<b>Power</b> 50 / 65 / 80 kW	<b>Table</b> Floating	<b>Table height</b> 53.5 – 85 cm
---------------------------------	--------------------------	-------------------------------------



**Highlights**

- High-performance automatic general radiographic system
- Auto positioning function
- Synchronized movements
- Next generation collimator with auto-filtering function
- High-load capacity table

- Space saving installation concept
- Upgradeability to a fully-fledged digital system

**Bucky**

**Shimadzu · RADspeed Pro MC**

<b>Power</b> 50/65/80 kW	<b>Table</b> Floating	<b>Table height</b> 53.5–85 cm
-----------------------------	--------------------------	-----------------------------------



**Highlights**

- Generator with high-frequency inverter technology
- Long vertical travel of ceiling-mounted tube support
- High-load capacity table
- Space saving installation concept
- Upgradeability to a fully-fledged digital system

**Shimadzu · RADspeed Pro MF**

<b>Power</b> 50/65/80 kW	<b>Table</b> Floating	<b>Table height</b> 53.5–85 cm
-----------------------------	--------------------------	-----------------------------------



**Highlights**

- Generator with high-frequency inverter technology
- Floor-mounted tube support
- High-load capacity table
- Space saving installation concept
- Upgradeability to a fully-fledged digital system

**Shimadzu · RADspeed Fit Plus**

<b>Power</b> 32/56 kW	<b>Table</b> Floating	<b>Table height</b> 70 cm
--------------------------	--------------------------	------------------------------



**Highlights**

- Ultra compact X-ray unit
- Heavy load capacity of floating X-ray table
- Up to 432 application programs
- Flexible positioning of X-ray tube support
- Upgradeability to a fully-fledged digital system

**Stephanix · RAD Series**

<b>Power</b> Up to 80 kW	<b>Table</b> Floating	<b>Table height</b> Fixed / variable
-----------------------------	--------------------------	---



**Highlights**

- Designed for customising to your application and budgetary considerations
- Multi-functional and digital-ready
- Ergonomically shaped with floating table for easy positioning
- Small space requirement
- Wide range of general procedures
- Intuitive touch screen generator with 864 APR available
- Floor or ceiling tubestand
- Tomography
- Compact and reliable solution
- Upgradable to DR

**RADBOOK 2022**

---

Please visit us at  
**healthcare-in-europe.com**

**Villa Sistemi Medicali · Moviplan 800**

<b>Power</b> 32/40/50/65/80 kW	<b>Table</b> Floating	<b>Table height</b> Fixed / adjustable
-----------------------------------	--------------------------	---



**Highlights**

- Modular bucky system for general radiographic applications, musculo-skeletal diagnostic room or emergency ward
- Several configuration options: table available with motorized lift, floor-mounted or ceiling suspended tubestand
- Optional tomographic functionalities
- Available with standard or tilting chest stand
- Cassette size: 13 × 18–35 × 43 cm

DR Detectors

Agfa · Dura-line XD/XD+ detector series

Size	Detector type	Pixel size
10"/14"/17"	CsI	124 µm/140 µm/140 µm

Highlights

- Available in 3 sizes: 10", 14" and 17"
- Cesium Iodide scintillator
- Wireless, high-resolution, full field AED detectors that work with virtually any conventional or mobile X-ray equipment
- 3 Wi-Fi antennas to provide fast and reliable communication
- Cesium Iodide scintillator that delivers optimum image quality and potential dose reduction
- Choice of one battery (7.5 hours of operation) or two (maximum 15 hours of operation)
- A robust design that enables 1-metre drop height, and operation at temperatures of 0–40 °C
- WPA2-PSK cybersecurity to protect patient data



Agfa · DR 14s Detector

Size	Detector type	Pixel size
14 × 17"	CsI	125 µm

Highlights

- Extremely long battery autonomy of up to eight hours
- "Musica processing" for excellent contrast detail & exam-independent, consistent image quality
- Choice of Cesium Iodide (CsI) or Gadolinium Oxy-Sulphide (GOS) detector scintillator
- Improved workflow & examination speed
- Lightweight, small, high resolution Automatic Exposure Detection (AED) detector
- Offers optimal convenience & portability
- High DQE & optimal pixel size, for low dose examinations
- Easy to clean & disinfect
- Size: 46 × 38.4 × 1.5 cm



Agfa · DR 10s Detector

Size	Detector type	Pixel size
10 × 12"	CsI / GOS	148 µm

Highlights

- Lightweight, high resolution Automatic Exposure Detection (AED)
- Offers optimal convenience & portability
- Easy cleaning & disinfection
- Compact detector fits into incubator bucky tray
- Seamless use with virtually all X-ray systems and maximizing the use of the existing X-ray equipment
- High DQE & optimal pixel size, for low dose examinations
- Extremely long battery autonomy of up to eight hours
- "Musica processing" for excellent contrast detail & exam-independent, consistent image quality
- Size: 251.0 × 314.5 mm (10 × 12 inch) (Effective area)



Canon Electron Tubes & Devices · FDX A4343R

Size	Detector type	Pixel size
43 × 43 cm	CsI / TI	140 µm

Highlights

- Our proven advanced fine CsI/TI and direct deposition technologies provide high resolution and high contrast.
- The reflective coating in the CsI/TI screen provides high sensitivity.
- Standard cassette size
- Prompt display of preview / full images and short cycle time enable fast image acquisition.
- Unique moisture-proof sealing method provides an extremely reliable CsI/TI screen that is protected from degradation.
- AED available

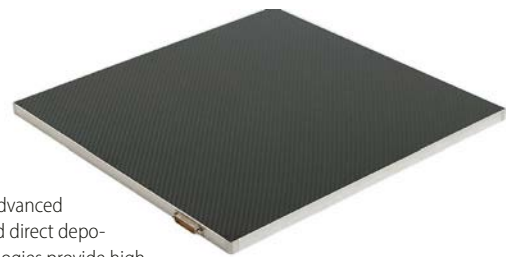

Canon Electron Tubes & Devices · FDXA 3543 RPW / FDXA 4343 RPW

Size	Detector type	Pixel size
35 × 43cm / 43 × 43 cm	CsI / TI	125 µm

Highlights

- Wireless type Portable FPD
- Incorporates our proven advanced fine CsI/TI and direct deposition technologies
- Unique moisture-proof sealing method used for the CsI/TI screen
- Standard cassette size
- Automatic switching between wireless / tethered mode
- Short cycle time (less than 10 s)
- Recharging in tethered mode
- Detachable cable connector



Canon Electron Tubes & Devices · FM3543S-D6T / FM4343S-D6T

Size	Detector type	Pixel size
35 × 43 cm / 43 × 43 cm	CsI / TI	140 µm

Highlights

- FPD Module (TFT panel with CsI & IC)
- Incorporates Canon's proven advanced fine CsI/TI and direct deposition technologies
- Unique moisture-proof sealing method used for the CsI/TI screen
- World leading image quality
- Fast solution for high performance in cassette-sized FPD
- Distinguished unique FPD
- Extraordinary performance
- Minimum cost and shortest time

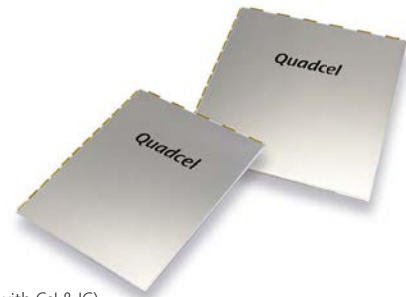

DR Detectors

Canon Electron Tubes & Devices · FDX2121F

Size 21 × 21 cm	Detector type CsI/Tl	Pixel size 205 μm
--------------------	-------------------------	----------------------



Highlights

- Dynamic FPD for mobile C-Arm
- Our proven advanced fine CsI/Tl and direct deposition technologies provide high DQE and better resolution
- Unique moisture-proof sealing method provides an extremely reliable CsI/Tl screen that is protected from degradation
- High speed & low-noise ROIC provide low-noise and real time image

Canon Electron Tubes & Devices · FDXA3543RP

Size 35 × 43 cm	Detector type CsI/Tl	Pixel size 140 μm
--------------------	-------------------------	----------------------



Highlights

- Portable flat panel detector
- Our proven advanced fine CsI/Tl and direct deposition technologies provide high MTF and excellent resolution
- Unique moisture-proof sealing method provides an extremely reliable CsI/Tl screen that is protected from degradation
- Standard cassette size
- Prompt display of preview / full images and the short cycle time enable fast image acquisition
- Compact and lightweight for easy handling
- DC power input type is selectable

Canon · CXDI Control Software NE



Highlights

- CXDI control software NE is made exclusively for use with Canon digital radiography systems. This software helps to optimise workflow and reduce the procedure steps needed to complete exams.
- Instant viewing of high quality images
  - Optimised workflow with minimum operation steps
  - Interactive GUI for intuitive operation
  - Single and prepacked protocols
  - Emergency study capability
  - Suspend exam / reject analysis
  - Automatic forwarding rejected images to a designated analysis workstation
  - Automatic image stitching included
  - Scatter correction software (optional)
  - Advanced edge enhancement software (Optional)

Canon · One Shot Long-Length (optional) Software



Highlights

- One shot long-length exams enhance efficiency compared to conventional stitch exams; shorter examination time, lower risk on patient movement, reduced dose and increased image quality.
- Patient positioning stand with motorised height adjustment for easy positioning
  - Fixed installation or mobile for convenient reallocation
  - Large, ergonomic grip rails for confident patient positioning
  - Optional grid
  - Ability to use three existing detectors for cost-effective one shot long-length imaging
  - Versatile configuration; use either 3 × 43 × 42 cm (410 CW) or 3 × 35 × 43 cm (710 W) wireless detectors

Canon · CXDI-410C / 710C / 810C Wireless

Size 27.4 × 35 / 35 × 43 / 43 × 42 cm	Detector type CsI	Pixel size 125 μm
--	----------------------	----------------------



Highlights

- Wireless flat panel detector range
- Ultralight wireless detectors
  - Increased durability by strong carbon fiber construction techniques
  - Ergonomic detector design for easy hold, easy handle and easy position
  - Dust- and water proof (IP57)
  - Docking station for detector check-in, detector battery charging and image transfer
  - Equipped with on-board memory where 99 images can be stored (in stand-alone-mode)

Canon · CXDI-RF Wireless B1

Size 43 × 42 cm	Detector type CsI	Pixel size 160 μm
--------------------	----------------------	----------------------



Highlights

- True dynamic and static imaging in one detector
- Low weight 3.5 kg
  - Wired and wireless
  - Water and dustproof IP57
  - Optional scatter correction software for static and dynamic imaging
  - Maximum flexibility in a clinical setting
  - Ergonomic design for easy hold, handle and position

DR Detectors

Canon · CXDI-402C/702C Wireless

Size	Detector type	Pixel size
35×43 / 43×42 cm	CsI	125 μm



Highlights

- Wireless flat panel detector range
- Durable and ergonomic shaped wireless detectors
- Ergonomic detector design for easy hold, easy handle and easy position
- Dust- and water proof (IP55)
- Optional docking station for detector check-in, detector battery charging and image transfer
- Equipped with last image hold for secured image transfer

Canon · DR-Upgrade-within-2-minutes

Size	Detector type	Pixel size
43×42/35×43/27.4×35 cm	CsI	125 μm



Highlights

- Easy upgrade solution for any X-ray system in two minutes using just two components
- No connections or modifications to your existing X-ray system is necessary
- Easily add DR to any X-ray system using just two lightweight components
- Simply pick up and move to any X-ray system
- Optional integrated USB DAP meter
- CXDI-410C / 710C / 810C / 402C / 702C wireless flat panel detector
- DR upgrade within 2 minutes. Freedom within reach

Del Medical · Delworks EDR

Size	Detector type	Pixel size
43×108 / 43×43 / 35×43 / 24×30 cm	GOS / CsI	140 / 148 μm



Highlights

- Powerful and user-friendly retrofit DR system
- Choice of wireless detectors
  - E17C fixed: 43×43 cm
  - E14C wireless, premium: 35×43 cm
  - E14CE economical: 35×43 cm
  - E2430: 24×30 cm
  - Delworks LLI monolithic: 43×107 cm for long length imaging
- Single workstation for image display and processing and integrated generator control
- Delworks FIT mobile tablet-based workstation option for ultimate portability
- Cyber secure and HIPAA compliant Windows 10 operating system

DRGEM · AcquiDR

Size	Detector type	Pixel size
43×36 cm / 43×43 cm	GOS / CsI	–



Highlights

- System concept: DR retrofit solution
- Radmax acquisition workstation
- Turns any analog X-ray system into a fully digital radiography system
- Easy to apply to any X-ray generator (AED function included)
- DICOM 3.0 compatible
- Simple installation and operation
- Optional image stitching program
- Optional AI software available
- Vet software available
- Detector format: 17×17" / 17×14", wired/wireless

Examion · X-DR

Size	Detector type	Pixel size
14×17" / 17×17"	a-Si / CsI	100 – 150 μm



Highlights

- Customized retrofit solutions for stationary, mobile and portable X-ray equipment.
- The right detector for any application.
- Detector: 14×17" / 17×17"
- Excellent image quality
- Perfectly matched hardware and software components
- Reliable workflow

Fujifilm · FDR D-EVO series

Size	Detector type	Pixel size
24×30 cm – 125×43 cm	GOS / CsI	150 μm



Highlights

- Now including the new ultra-light-weight FDR D-EVO III featuring an innovative flexible film based TFT layer, significantly reducing weight and further improving durability.
- FDR D-EVO series detectors are rugged, lightweight, water-resistant digital detectors, available in CsI or GOS and featuring high DQE and low noise at ultra-low doses.
- Patented IIS technology, Smartswitch AED, built-in image storage, and a Fujifilm exclusive antibacterial nano coating.
- 24×30 cm to the Longview 125×43 cm FPD sizes.



DR Detectors

**Konica Minolta · AeroDR HD**

Size 14×17"	Detector type Csl	Pixel size 100 µm
----------------	----------------------	----------------------



**Highlights**

- Portable digital X-ray detector
- Pixel size: 100 µm – high definition
- Able to display micro structures
- Better visibility of bone trabecular
- No "pixel shape" when zooming in
- Lightweight for easy handling: 2.6 kg
- Load resistance of 400 kg
- 130 kg bending resistance
- Two second preview
- Waterproof IPX6

**Konica Minolta · AeroDR NS**

Size 14×17"	Detector type Csl	Pixel size 150 µm
----------------	----------------------	----------------------



**Highlights**

- Ideal for CR replacement
- ImagePilot all-in-one console for registration + acquisition + viewer + measurements + miniPACS functionality
- Automatic Exposure Detection (AED) no cable connections needed
- Internal access point
- AeroStorage for working offline
- Bone suppression options

**Konica Minolta · AeroDR 1417 HD3**

Size 14×17" / 35×43 cm	Detector type Csl	Pixel size 100 µm
---------------------------	----------------------	----------------------



**Highlights**

- Antibacterial Carbon SMC cover
- Pixel size: 100 micron High Definition
- DDR Ready
- AeroDR Storage mode to store images
- MIL-STD-810G military drop test certified
- Lightweight for easy handling: 2.6 kg
- Load resistance of 400 kg
- 130 kg bending resistance
- Two second preview
- Waterproof IPX6

**Konica Minolta · AeroDR 1417 HL - GIF**

Size 14×17" / 35×43 cm	Detector type Csl	Pixel size 100 µm
---------------------------	----------------------	----------------------

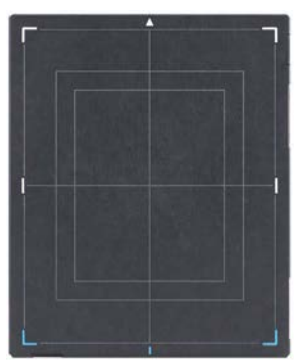

**Highlights**

- Glass-free detector
- Lightest-weight detector – 1.9 kg
- Higher DQE
- Antibacterial Carbon SMC cover
- Pixel size: 100 micron High Definition
- AeroDR Storage mode to store images
- MIL-STD-810G military drop test certified
- Load resistance of 400 kg
- 130 kg bending resistance
- Waterproof IPX6

**medigration · DR Retrofit-Kit DX | Vision**

Size 35×43 cm	Detector type a-Si / Csl	Pixel size 148 µm
------------------	-----------------------------	----------------------



**Highlights**

Wireless, portable detector with WLAN and battery

- Easy integration into an existing X-ray system
- 100 percent touch-capable user interface
- Cordless and lightweight wireless flat panel detector
- For the use with mobile X-ray systems
- Auto-trigger mode (AED function) – no need to synchronise with the generator
- Excellent image quality through an integrated operating program with HARMONY image processing
- Detector format: 35 × 43 cm

**OR Technology · Medici DR upgrade**

Size 12×10" / 14×17" / 17×17"	Detector type Csl	Pixel size 100/120/139/140/154 µm
----------------------------------	----------------------	--------------------------------------



**Highlights**

Upgrading to digital made easy!  
X-ray detector retrofit for your existing stationary and mobile X-ray system

Two versions of the system are available:

- DR retrofits with wireless X-ray detector incl. dicomPACS DX-R acquisition and diagnostic software for X-ray images with touch screen
- DR retrofits with tethered X-ray detector incl. dicomPACS DX-R acquisition and diagnostic software for X-ray images with touch screen

DR Detectors

Stephanix · Nomad DReam

Size 14×17" / 17×17"	Detector type Various types & brands	Pixel size 125 µm / 148 µm
-------------------------	---	-------------------------------



Highlights

- To get easily the digital benefits in analogue x-ray rooms and mobile units
- No modification or generator connection
- Several panel brands and sizes are available
- Advanced functions: APR, post-processings
- DICOM connectivity
- Shareable solution with other Stephanix modalities

Stephanix · New WiFi Dynamic FPD

Size 17" × 17"	Detector type CsI	Pixel size 160 µm
-------------------	----------------------	----------------------



Highlights

- 20 years ago, Stephanix was a "digital" pioneer by installing a Flat Panel Detector in a remote-controlled table.
- Stephanix remains a leader in its category by integrating WiFi portable dynamic FPD in its remote systems.
- Wired and wireless, true dynamic and static imaging inside the bucky and direct projections outside the bucky, so easily with one detector.
- Low weight 3.5 kg
- Water and dustproof IP57
- Stephanix, french manufacturer and integrator, generator of talent

Swissray · ddRAura DRiveKit

Power -	Detector type a-Si / CsI	Pixel size 148 / 139 µm
------------	-----------------------------	----------------------------



Highlights

Truly digital radiography upgrade

- Detector size: 43×43 cm, 35×43 cm or 24×30 cm

Fix workstation:

- 23" DICOM touch screen monitor
- Cristal clear digital images, available in less than four seconds
- Fixed or wireless detector combination options
- Fully integrated DR workstation with generator control option

Portable workstation:

- Medical grade windows OS tablet with 10" touch screen display
- ddRAura user interface
- Less than 1 kg weight
- Withstands drops of up to 1.5 m
- Docking station with 23" monitor option

Villa Sistemi Medicali · VDX 3543PW

Size 35×43 cm	Detector type aSi / CsI	Pixel size 100 µm
------------------	----------------------------	----------------------

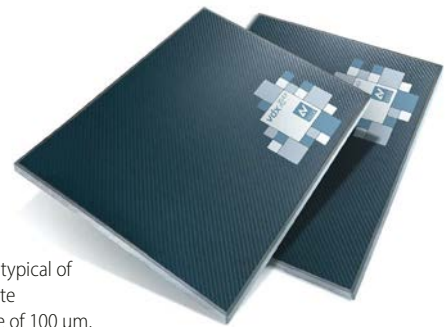

Highlights

- Complete cordless positioning freedom, typical of a conventional cassette
- Outstanding pixel size of 100 µm, for the highest image quality
- Auto-triggering mode: the detector automatically synchronizes the acquisition once the X-ray source starts the emission
- System equipped with battery charger and two batteries as standard
- Enhanced productivity with DICOM functions

Villa Sistemi Medicali · VDX 3543TC

Size 35×43 cm	Detector type a-Si / CsI	Pixel size 143 µm
------------------	-----------------------------	----------------------



Highlights

- Portable lightweight design flat panel fitting into existing bucky without modification
- Increased workflow
- Cost-effective solution, integrating a tether cable for both detector powering and image transferring
- Easy handling from chest stand to bucky table for upright, in-table, lateral and out of bucky exposures
- Enhanced productivity with DICOM functions

EUROPEAN HOSPITAL

Please visit us at

[european-hospital.com](http://european-hospital.com)

WE WILL  
**NEVER STOP** INNOVATING FOR  
A HEALTHIER WORLD

Introducing  
**Fujifilm's Expanded Portfolio**  
of **Healthcare Solutions**

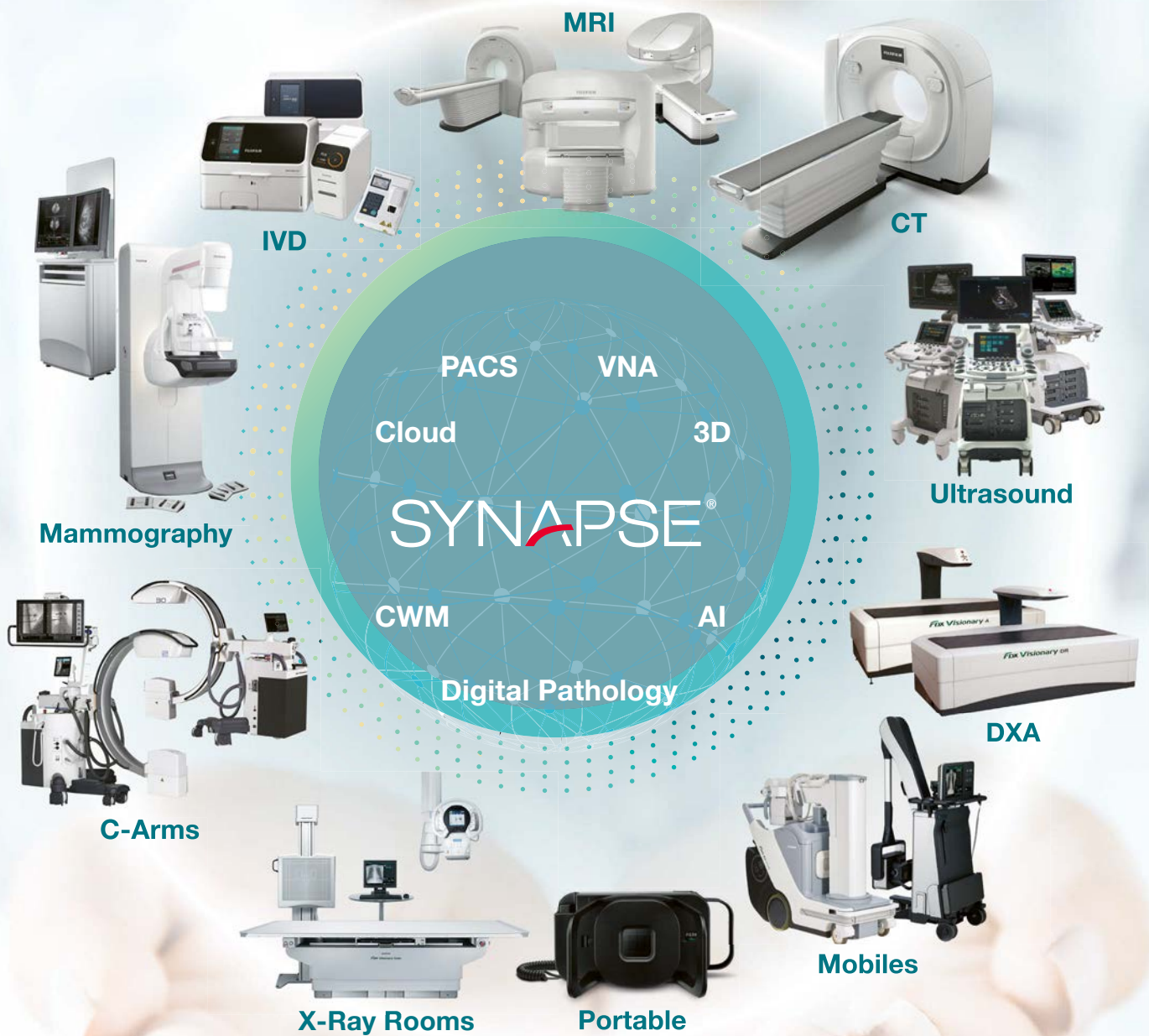

CR

Agfa · CR 30-Xm\*

Slots	Capacity	Resolution
1	82 Plates/h	10 – 20 Pixel/mm



Highlights

- Tabletop digitizer
- Broad range of applications: mammography, general radiography, orthopaedics, chiropractic, dental and FLFS
- No quality compromises
- Horizontal cassette insertion
- Low total cost of ownership
- Mobile use
- Cassette size: From 15×30 cm to 35×43 cm, incl. mammography

\*CR 30-XM not available in the US & Canada

Agfa · CR 15-X

Slots	Capacity	Resolution
1	102 Plates/h	5 – 10 Pixel/mm



Highlights

- Affordable for a broad range of applications
- Convenient and fast workflow, with usercontrollable speed and resolution
- Robust yet easy to install and maintain
- Fits in small spaces and is suited for mobile applications
- Highly versatile, compact CR 15-X offers an ideal solution for decentralised hospital environments, clinics and private practices.
- Size: 580×700×471 mm (w×d×h)

Agfa · CR 12-X

Slots	Capacity	Resolution
1	Up to 78 Plates/h	5 - 10 Pixel/mm



Highlights

- Affordable CR system offering high image quality
- Customer-chosen optimal workflow
- Robust, yet easy to install and maintain
- Suited for mobile applications
- Networking capabilities deliver seamless integration
- Cassette size: From 15×30 cm to 35×43 cm, incl. mammography

Agfa · CR 10-X

Slots	Capacity	Resolution
1	34 Plates/h	10 Pixel/mm



Highlights

- Affordable CR solution that makes no compromises in image quality
- For a convenient and fast workflow
- Robust, yet easy to install and maintain
- Fits in small spaces and is suited for mobile applications
- Networking capabilities deliver seamless integration
- Cassette size: 35×43 cm

Agfa · DX-M\*

Slots	Capacity	Pixel size
1 – 5	83 Plates/h	6.7 – 20 Pixel/mm



Highlights

- DX-M: Mixed to perfection
- Next-generation CR digitizer
- NIP and PIP detectors for general radiography and mammography
- Superb image quality and potential for dose reduction
- Five cassette drop-and-go buffer
- Small footprint
- Musica Image Processing
- Cassette size: From 15×30 cm to 35×43 cm, incl. mammography

\*DX-M with CR Mammography application is not available in the US

Konica Minolta · Regius Sigma II

Slots	Capacity	Pixel size
1	60 Plates/h	87.5 / 175 µm



Highlights

- Only 28 kg
- Foot print only 0.31 m<sup>2</sup>
- Ultra compact: Konica Minolta's smallest and lightest CR reader
- Environmentally friendly with an energy consumption of max. 100 VA
- Cassette size: From 18×24 cm to 35×43 cm

CR

**OR Technology · Divario CR-T2 / CR-Tm**

Slots	Capacity	Resolution
1	73 Plates/h	10 Pixel/mm



**Highlights**

- Small – compact desktop unit (0.30 m<sup>2</sup> footprint)
- High quality – constant, high-resolution image quality
- Flexible – portable, suited for mobile use; Stitching (optional) – for full spine and long leg X-ray images – the separate images are stitched together automatically (auto-stitching)
- Fast – maximum processing capacity: 73 cassettes per hour for 18 × 24 cm format
- Divario CR-Tm – with extra high resolution up to 50 μm (mammography compatibility)

Flatpanel Fluoro

**Agfa · DR 800 (Fluoroscopy)\***

Power	Detector type	Pixel size
50/65/80 kW	CsI	<150 μm



**Highlights**

- Digital Subtraction Angiography (DSA) and Roadmapping
- With the plug-and-play SmartRotate, every image is presented ready for viewing, directly and automatically
- Dynamic 3-in-1 direct radiography system offering real time images
- Single touch, remote-controlled user-interface and table auto-positioning, improving workflow and maximizing patient comfort
- Wide range of fluoroscopy, general radiography and portable applications, incl. optional full leg / full spine and digital tomosynthesis
- Includes gold-standard "Musica image processing" for dynamic images

*\* Not available in Canada*

**Canon · Xantara**

Power	Detector type	Pixel size
80 kW	CsI	148 μm



**Highlights**

- The Xantara system is designed to provide maximum flexibility for all types of exam rooms and for all types of exams.
- From the clean, sleek lines of the design, to the simplified all-in-one control console, to the mechanical ergonomics and elegance, the Xantara is the remote controlled table solution like you've never seen before.
- Source-to-imager distance 180 cm.
- Four-way movement of tabletop.
- Optional second X-ray tube, vertical bucky stand and wireless FPD.
- Detector size: 43 × 43 cm

**Canon · Ultimax-i**

Power	Detector type	Pixel size
80 kW	CsI	148 μm



**Highlights**

- The Ultimax-i system provides a multipurpose digital X-ray system with a tilting C-arm table for multipurpose diagnostic applications and interventional radiology
- An additional ceiling mounted X-ray tube can be combined
- This system can be used for a wide variety of clinical applications
- Optional 55 inch monitor
- Detector size: 43 × 43 cm

**Canon · Adora DRFi**

Power	Detector type	Pixel size
80 kW	CsI	160 μm



**Highlights**

Next generation high-end hybrid solution for all radiographic applications

- Efficient examination cycles and increased patient comfort
- Combines radiography, low dose fluoroscopy and serial imaging
- APR auto-positioning with up to 999 positions
- Motorized manual handling using SmartHandle joystick
- Intuitive, icon-based user controls at the tube head
- Configurable controls to meet clinical requirements
- Table: Motorized, carbon fiber, floating top with 340° rotation

**Del Medical · Apollo DRF 4.0\* by Villa**

Power	Detector type	Pixel size
65 – 80 kW	a-Si / CsI	148 μm



**Highlights**

- All-in-one, direct radiography and fluoroscopy system with remote controlled table
- Ultimate positioning flexibility – 90° tilt in both directions, motorized column tilting and SID adjustment up to 180 cm with head to toe patient coverage
- Advanced digital tomosynthesis functionality
- Unrestricted table patient weight limit of 284 kg
- Sensitive and dose conscious 43 × 43 cm dynamic flat panel detector for high quality real-time or static images
- Intuitive user interface

*\* Available for US market only*

Flatpanel Fluoro

**GMM Group · Opera Sharp Evolution – Remote-controlled system**

Power 50 – 80 kW	Detector type a-Si	Pixel size 139 – 148 µm
---------------------	-----------------------	----------------------------



**Highlights**

- Exclusive cross-levers system for a safe positioning of the patient
- High longitudinal travel and free access to the table from all four sides
- Dual grid system for an appropriate grid selection
- Fully-integrated solution for high image quality
- Dose reduction, removable grid and advanced software algorithms, also for paediatric patients
- Advanced procedures and long skeletal segments reconstruction

**GMM Group · Opera Swing – Multifunctional system**

Power 50 – 80 kW	Detector type a-Si	Pixel size 139 – 148 µm
---------------------	-----------------------	----------------------------



**Highlights**

- Revolutionary RF system with 13 degrees of freedom
- Cantilevered adjustable height table to improve system accessibility
- Execution of exams in direct contact with the unconstrained detector
- Easy execution of lateral and oblique projections
- Autofocusing Grid solution for the best focalization
- Intuitive interface, fast workflow and high image quality in any standard and advanced procedure

**GMM Group · Opera Evolution – R/F Remote-controlled tables**

Power 50 – 80 kW	Detector type a-Si	Pixel size 139 – 148 µm
---------------------	-----------------------	----------------------------



**Highlights**

- Result of years of experience and best-seller among RF systems
- Configurable for a wide range of applications
- Compact and ergonomic design for an easy placement
- Dual Grid System for the selection of the most appropriate grid
- Dose reduction, intuitive gesture and post-processing functions to improve diagnostic exams
- Stitching and advanced imaging procedures (DSA, Dual Energy and Tomosynthesis)

**GMM Group · Clisis Evolution – Remote controlled**

Power 65 – 80 kW	Detector type a-Si	Pixel size 139 – 148 µm
---------------------	-----------------------	----------------------------



**Highlights**

- Four-way floating tabletop with a rear accessibility
- Minimum table to floor distance for a safer patient access
- Autofocusing Grid for a wide range of focal distances
- Software algorithms (Virtual Grid and Virtual Scan) for high image quality and low dose
- Tomosynthesis, Dual Energy, Stitching and DSA for specialized examinations
- Fast and efficient workflow in a single integrated imaging system

**NRT · Celex – Powered by Canon DR**

Power 80 kW	Detector type CsI	Pixel size 160 µm
----------------	----------------------	----------------------



**Highlights**

Next generation multi-purpose tilt C-arm solution

- Hybrid offering fluoroscopic, serial and radiographic imaging
- Table load capacity of 300 kg; best in class SID of 150 cm
- Intuitive controls, focus on ergonomics and patient comfort
- Save and restore any position – permanently or on the fly
- Detachable table option for maximum examination flexibility
- Small foot print and maximum work areas for staff
- Table: Left or right side suspended; detachable table option

**NRT · Adora DRFi – Powered by Canon DR**

Power 80 kW	Detector type CsI	Pixel size 160 µm
----------------	----------------------	----------------------



**Highlights**

Next generation high-end hybrid solution for all radiographic applications

- Efficient examination cycles and increased patient comfort
- Combines radiography, low dose fluoroscopy and serial imaging
- APR auto-positioning with up to 999 positions
- Motorized manual handling using SmartHandle joystick
- Intuitive, icon-based user controls at the tube head
- Configurable controls to meet clinical requirements
- Table: Motorized, carbon fiber, floating top with 340° rotation

Flatpanel Fluoro

**Shimadzu · Sonialvision G4 LX Edition**

<b>Power</b> 65/80 kW	<b>Detector type</b> Csl	<b>Pixel size</b> 139 µm
--------------------------	-----------------------------	-----------------------------



**Highlights**

- Premium R/F system with dynamic flat panel detector
- Second tube option for multi purpose room solution
- SID 180 cm option
- Bariatric functionality
- Real-time image enhancement processing technology
- Tomosynthesis and T-smart
- Slot radiography
- Angiography option (real-time and motion-tolerant RSM-DSA)
- Comprehensive dose management package
- Size: 17×17" (43×43 cm)

**Shimadzu · Flexavision F4\***

<b>Power</b> 50/80 kW	<b>Detector type</b> Csl	<b>Pixel size</b> 160 µm / 125 µm
--------------------------	-----------------------------	--------------------------------------



**Highlights**

- Wireless dynamic FPD for various studies from head to toe
- Outstanding digital image quality
- Great flexibility through smart modular technology
- 2nd tube option for multi purpose room solution
- Size: 17×17" (42×43 cm)
- 17×14" (43×35 cm)
- 14×11" (35×27 cm)

*\* Product is not available in all countries.*

**Shimadzu · FLUOROsPEED X1 Edition\***

<b>Power</b> 80 kW	<b>Detector type</b> Csl	<b>Pixel size</b> 160 µm
-----------------------	-----------------------------	-----------------------------



**Highlights**

- Premium patient-side R/F system with dynamic flat panel detector
- Imaging deck with Glide Assist technology
- FPD size: 17×17" (43×43 cm)
- Second tube for multipurpose room solution
- Superb table operability for easy operation and patient convenience
- Bariatric functionality
- Real-time image enhancement processing technologies
- Comprehensive dose management package

*\* Product is not available in all countries*

**Siemens Healthineers · Luminos Lotus Max**

<b>Power</b> 65/80 kW	<b>Detector type</b> a-Si / Csl	<b>Pixel size</b> 148 µm
--------------------------	------------------------------------	-----------------------------



**Highlights**

- Flow in system operation thanks to seamless integration of all components
- Flow in clinical versatility with a wide range of examinations and diverse patient types
- Flow in dose management thanks to pre-defined organ programs, proven dose-saving CARE focus and image processing
- Unlock the potential of your X-ray department with Fleet Level Benefits
- High level of cybersecurity
- Detector size: 43×43 cm (MAX detector) 35×43 cm (MAX wi-D) 24×30 cm (MAX mini)

**Siemens Healthineers · Luminos Impulse**

<b>Power</b> 65 kW / 80 kW	<b>Detector type</b> a-Si / Csl	<b>Pixel size</b> 148 µm
-------------------------------	------------------------------------	-----------------------------



**Highlights**

- Trust your results – Excellent image quality and low radiation dose
- Optimize your capabilities – High-value all around through clinical versatility
- World-class service and support – For continuous operations
- Unlock the potential of your X-ray department with Fleet Level Benefits
- High level of cybersecurity
- Detector size: 43×43 cm (MAX detector) 35×43 cm (MAX wi-D)

**Siemens Healthineers · Luminos dRF Max**

<b>Power</b> 65/80 kW	<b>Detector type</b> a-Si / Csl	<b>Pixel size</b> 148 µm
--------------------------	------------------------------------	-----------------------------



**Highlights**

- Stronger synergies – with a true 2-in-1 solution for radiography and fluoroscopy
- Sharper imaging – for fast, confident diagnosis with a large 43×43 cm Max dynamic detector
- Safer use – to protect patients and technologists with a 48 cm minimum table height, full patient access from all sides and SmartTouch
- Unlock the potential of your X-ray department with Fleet Level Benefits
- Detector size: 43×43 cm (MAX detector) 35×43 cm (MAX wi-D) 24×30 cm (MAX mini)

Flatpanel Fluoro

Siemens Healthineers · Luminos Agile Max

Power	Detector type	Pixel size
65 / 80 kW	a-Si / CsI	148 µm



**Highlights**

- Stronger synergies – with a true 2-in-1 solution
- Sharper imaging – for fast, confident diagnosis
- Safer use – to protect patients and technologists
- Detector size:
  - 43×43 cm (MAX detector)
  - 35×43 cm (MAX wi-D)
  - 24×30 cm (MAX mini)
- Unlock the potential of your X-ray department with Fleet Level Benefits
- Ysio Max options:
  - Fully integrated ceiling-suspended tube with bucky tracking
  - MAX wi-D and MAX mini detectors
  - SmartOrtho: long leg and full spine imaging

Siemens Healthineers · Luminos Fusion

Power	Detector type	Pixel size
65 / 80 kW	a-Si / CsI	148 µm



**Highlights**

- Max image quality in R/F (FD version only)
- Technology from high-end Max systems
- Easy access for fast and easy patient positioning
- Touch-sensitive joysticks
- Outstanding dose reduction with CARE
- Wide range of options and applications
- 2-in-1 efficiency: flexibility and high utilization saves space and costs
- Unlock the potential of your X-ray department with Fleet Level Benefits
- Detector size: 43×43 cm

Siemens Healthineers · Multitom Rax

Power	Detector type	Pixel size
65 / 80 kW	a-Si / CsI	148 µm



**Highlights**

- The worlds first twin robotic X-ray scanner
- Set new standards in advanced musculoskeletal and trauma imaging
- Optional with Real3D and True2scale imaging
- Precise insights through unique automation
- Efficient workflows around your patients
- Comprehensive diagnoses with multiple procedures
- Unlock the potential of your X-ray department with Fleet Level Benefits
- Detector size:
  - 43×43 cm (RAX detector)
  - 35×43 cm (MAX wi-D)
  - 24×30 cm (MAX mini)

Stephanix · Remote Controlled Systems range

Power	Detector type	Pixel size
Up to 80 kW	a-Si / CsI	148 µm / 160 µm



**Highlights**

- +90° and -90° tilting
- Unmatched variable height from 38 to 148 cm
- Unmatched patient coverage
- Patient weight up to 310 kg
- Autopositioning regarding each protocol
- Motorized: Automatic positioning, collimation, filtration, parameters
- Smart access for secure patient transfer
- Intuitive user interface
- Wireless remote
- Secondary console
- DSA
- Stitching
- Tomosynthesis
- Dose optimization with virtual collimation, additional filtration, video camera ...

Stephanix · D<sup>2</sup>RS

Power	Detector type	Pixel size
Up to 80 kW	a-Si / CsI	148 µm / 160 µm



**Highlights**

- Unmatched patient coverage
- Patient weight up to 310 kg
- Autopositioning regarding each protocol
- Smart access for secure patient transfer
- Dose optimization with virtual collimation, additional filtration, video camera ...
- Intuitive user interface
- Wireless remote
- Secondary console
- DSA
- Stitching
- Tomosynthesis
- Second tubestand and additional detectors
- Motorized: Automatic positioning, collimation, filtration, parameters

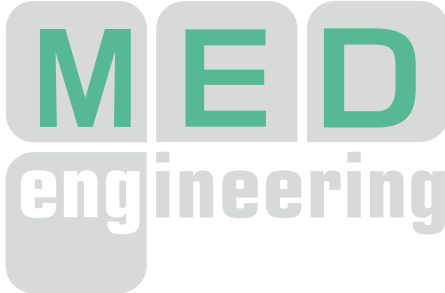

Please visit us at  
[med-eng.de](http://med-eng.de)



**Flatpanel Fluoro**

**Stephanix · D<sup>2</sup>RS 90/90 – Powered by Canon DR**

<b>Power</b> Up to 80 kW	<b>Detector type</b> a-Si / CsI	<b>Pixel size</b> 160 μm
-----------------------------	------------------------------------	-----------------------------

**Highlights**

- +90° and -90° tilting
- Unmatched variable height from 38 to 148 cm
- Unmatched patient coverage
- Patient weight up to 310 kg
- Autopositioning regarding each protocol
- Motorized: Automatic positioning, collimation, filtration, parameters
- Smart access for secure patient transfer
- Intuitive user interface
- Wireless remote
- Secondary console
- DSA / stitching / tomosynthesis
- Dose optimization with virtual collimation, additional filtration, video camera ...
- True Dynamic and Static Imaging in one detector



Powered by Canon DR



**KU**  
GESUNDHEITSMANAGEMENT

Please visit us at  
[ku-gesundheitsmanagement.de](http://ku-gesundheitsmanagement.de)

**Stephanix · D<sup>2</sup>RS – Powered by Canon DR**

<b>Power</b> Up to 80 kW	<b>Detector type</b> a-Si / CsI	<b>Pixel size</b> 160 μm
-----------------------------	------------------------------------	-----------------------------

**Highlights**

- Unmatched patient coverage
- Patient weight up to 310 kg
- Autopositioning regarding each protocol
- Smart access for secure patient transfer
- Dose optimization with virtual collimation, additional filtration, video camera ...
- Intuitive user interface
- Wireless remote
- Secondary console
- DSA / stitching / tomosynthesis
- Second tubestand and additional detectors
- Motorized: Automatic positioning, collimation, filtration, parameters
- True Dynamic and Static Imaging in one detector



Powered by Canon DR

**Villa Sistemi Medicali · Apollo DRF 4.0**

<b>Power</b> 65 – 80 kW	<b>Detector type</b> a-Si / CsI	<b>Pixel size</b> 148 μm
----------------------------	------------------------------------	-----------------------------

**Highlights**

- Premium digital remote controlled system for full clinical coverage in R/F applications
- New tomosynthesis function
- New borderless tabletop and touch screen collimator
- New touch screen control console with integrated intercom system and smart-touch joysticks
- Simplified patient positioning system through integrated camera
- Available with DSA and stitching options
- Detector size: 43 × 43 cm



**Villa Sistemi Medicali · Apollo EZ DRF 4.0**

<b>Power</b> 65 – 80 kW	<b>Detector type</b> a-Si / CsI	<b>Pixel size</b> 148 μm
----------------------------	------------------------------------	-----------------------------

**Highlights**

- Compact and cost-effective digital system for all the needs of radiographic and R/F imaging
- New tomosynthesis function
- Touch screen collimator
- New touch screen control console with integrated intercom system and smart-touch joysticks
- Simplified patient positioning system through integrated camera
- Available with DSA and stitching options
- Detector size: 43 × 43 cm



**Villa Sistemi Medicali · Apollo Open DRF 4.0**

<b>Power</b> 65 – 80 kW	<b>Detector type</b> a-Si / CsI	<b>Pixel size</b> 148 μm
----------------------------	------------------------------------	-----------------------------

**Highlights**

- Premium digital remote controlled system with open tabletop, allowing 4-side access to the patient
- New tomosynthesis function
- Touch screen collimator
- New touch screen control console with integrated intercom system and smart-touch joysticks
- Simplified patient positioning system through integrated camera
- Available with DSA and stitching options
- Detector size: 43 × 43 cm



# Cutting-edge product and clinical applications

## World-class technologies for healthcare

“With Your Stories – lifetime healthcare support” is the future-driven approach combining the best of two worlds by using our expertise in medical imaging systems and laboratory instrumentation to benefit patients through even better prevention, diagnosis, treatment and follow-up and thus help them in the pursuit of a healthy life.



### Medical Imaging Systems from Shimadzu

With more than 100 years of extensive clinical experience in X-ray technologies, the company provides a multitude of advanced radiographic and fluoroscopic systems. World-leading technology, and cutting-edge applications and functionalities enhance healthcare providers' examination efficiency and safety while reducing the radiation dose.

### Radiography & Fluoroscopy – Sonialvision G4 LX edition “Best-in-Class” digital multi-purpose R/F system

The Sonialvision G4 LX edition high-performance R/F table provides numerous best-in-class features significantly increasing its functionality and operability. The Sonialvision G4 LX edition unites the widest possible range of examinations and can be used inter-departmentally. The largest available FPD at 43 x 43 cm, a long imaging chain movement capability over 200 cm and SID extension up to 180 cm provide an extensive imaging area.

### NEW SCORE PRO Advance

This next-generation image processing technology significantly reduces background noise in real-time and offers a balanced optimization of fluoroscopic image quality and exposure level in various fluoroscopic examinations, such as ERCP, barium swallow, and other GI studies.

### SLOT Advance

This function provides fast and highly accurate images with long fields of view, such as for full spine or full leg images, taken with a minimal X-ray dose.

### Tomosynthesis, making the invisible visible

This state-of-the-art imaging technology offers high-quality multi-slice images in a simple and quick workflow, and at a low exposure dose. It enables images to be taken at any angle including weight-bearing exams required for diagnosis.

### Mobile DR System – MobileDaRt Evolution MX8

With the MobileDaRt Evolution MX8, Shimadzu, now offers the 8<sup>th</sup> generation. Mobile DR systems make an important contribution to modern imaging in clinical applications and optimize all internal hospital processes and cost structures. Since its introduction, the MobileDaRt series by Shimadzu has been much appreciated by users worldwide due to its excellent overall concept. So far, more than 6.000 systems of this series have been installed and effectively support mobile imaging in ICU/NICU and ER, in pediatrics and orthopedics, as well as applications in disaster areas.

The system concept offers innovations in mobility, functionality and digital imaging, such as:

- GLIDE VIEW™ function supports the newly developed collapsible column ensuring improved forward view and the power-assisted driving handle enabling comfortable travelling and easy system positioning in restricted spaces and between beds
- “All Free” and “Inch Mover” buttons allowing free one-step positioning of the X-ray tube
- Largest possible selection of highly sensitive detectors of its class, allowing flexible system configuration that matches individual clinical requirements
- Fully integrated 19-inch (48 cm) screen for improved operability
- Useful safety features, like lockable FPD storage bins, coded system access, sensitive system impact sensors and color-coded status indicators.



## Fluoroscopy

### Shimadzu · Flexavision eXceed Edition Series

<b>Power</b> 50/80 kW	<b>II format</b> 12"/9"	<b>CCD-matrix</b> 1024 × 1024 × 12 Bit CCD
--------------------------	----------------------------	---



#### Highlights

- 90° / 30° digital or analogue local R/F table
- Flexible configuration
- High reliability
- Turnable footrest
- Meets all requirements for routine R/F exams

### Villa Sistemi Medicali · Apollo 4.0

<b>Power</b> 50/65/80 kW	<b>II format</b> 9"/12"/16"	<b>CCD-matrix</b> 1 k x 1 k
-----------------------------	--------------------------------	--------------------------------



#### Highlights

- Premium remote controlled system for full clinical coverage in R/F applications
- Up to 180 cm Source to Image Distance
- Oblique projections at table edges and electronic tomography
- New touch screen control console with integrated intercom system and smart-touch joysticks
- Easy patient positioning system through integrated camera
- Possibility to perform stitching exam with portable wireless detector

### Villa Sistemi Medicali · Apollo EZ 4.0

<b>Power</b> 50/65/80 kW	<b>II format</b> 9"/12"	<b>CCD-matrix</b> 1 k × 1 k
-----------------------------	----------------------------	--------------------------------



#### Highlights

- Compact and cost-effective system for all the needs of radiographic and R/F imaging
- Up to 180 cm Source to Image Distance
- Oblique projections at table edges and electronic tomography
- New touch screen control console with integrated intercom system and smart-touch joysticks
- Easy patient positioning system through integrated camera
- Possibility to perform stitching exam with portable wireless detector

# RAD BOOK 2022

Please visit us at  
**healthcare-in-europe.com**

## Mobile DR

### Agfa · DR 100s

<b>Power</b> 32/40 kW	<b>Width</b> 57.6 cm	<b>Weight</b> 470 kg
--------------------------	-------------------------	-------------------------



#### Highlights

- Agfa's SmartXR features lighten the workload and provides a helping hand for fast, smooth image acquisition.
- Customer driven design, amazing usability and freedom of movement
- Smart Imaging, with MUSICA intelligence, for smooth, effective imaging
- Drive and park, with the FreeView collapsible column and height adjustable handle.
- Extended range of applications, for greater mobile flexibility
- Motorized: Up to 5 km/h
- Technology: Wireless – Amorphous Silicon Detector (a-Si)
- mAs Range : 70 - 400 mA selectable
- kV Range: 40 to 150 kVp

### Agfa · DR 100e

<b>Power</b> 32 kW	<b>Width</b> 61.8 cm	<b>Weight</b> 252 kg
-----------------------	-------------------------	-------------------------



#### Highlights

- Comfortable imaging experience for patient and operator
- Short exposure times and fast assessment of images after exposure
- Outstanding image quality and dose reduction potential Seamless connectivity with PACS, HIS / RIS and imagers
- Wireless detector for improved flexibility and infection control
- Your path to direct digital at your own pace
- Equipped with a powerful generator of up to 32 kW
- Operation: Plug / Motorized: No

Mobile DR

Examion · X-R Mobile 320

Power 32 kW	Width 61.8 cm	Motorized no
----------------	------------------	-----------------



Highlights

- The X-R Mobile 320 is a robust basic model of an X-ray system with good features and an affordable price.
- Compact
  - Easy maneuvering and positioning
  - Rotating column (optional)
  - Width: 61.8 cm
  - Weight: 170 kg

Fujifilm · FDR GO Plus

Power 32 kW	Width 56 cm	Weight 440 kg
----------------	----------------	------------------



Highlights

- Lightweight and compact ensures superb manoeuvrability.
- Collapsible column maintains a clear view ahead.
- Smooth low noise driving creating less disruption in the quietest environments.
- Multiple tube positioning releases and front/rear collimation controls for fast, easy operation.
- Compatible with D-EVO series GOS and cSI detectors.
- Up to four hours use on a single charge and features emergency reserve mode.
- 19" Monitor provides optimized image viewing.
- Integrated Console Advance provides advanced image processing like Virtual Grid and Dynamic Visualization II.

Fujifilm · FDR nano

Power 2.5 kW	Width 55 cm	Weight 90 kg
-----------------	----------------	-----------------



Highlights

- Groundbreaking compact, lightweight mobile x-ray cart only 90 kg
- Spin and Slide four-wheel castors enable superb movement control
- Utilizes D-EVO series detectors and Virtual Grid technology to maintain high image quality at lower doses
- Integrated Console Advance rotates freely for improved viewing from any position
- Up to twelve hours use (around 240 exposures) on a single charge of the Lithium-ion batteries
- Plug-in exposures, increases operation time
- Fujifilm exclusive antibacterial nano coating on high use areas a world first for mobile DR X-ray systems

Fujifilm · FDR Xair

Power 4.5 kW	Size 30 × 25 × 14 cm	Weight 3.5 kg
-----------------	-------------------------	------------------



Highlights

- FDR Xair's ultralight compact portable design provides a strong advantage when accessibility to normal medical treatment settings is difficult.
- FDR Xair can provide a portable solution and a high-mobility workflow even in unconventional medical scenes.
- The built-in lithium polymer battery enables up to 100 images in environments where there is no electricity\*.
- Flat-surface design provides easy cleaning and maintenance.
- Fast turn on and user-friendly simple button layout provides an efficient workflow.
- Highly durable LED light source for use in variable environments.

\*depends on the exposure conditions

GMM Group · MAC D – Mobile radiographic unit

Power 32 kW	Detector type a-Si	Pixel size 139 µm – 148 µm
----------------	-----------------------	-------------------------------



Highlights

- Compact and ultra-lightweight digital mobile unit
- Quick approach to bedridden/reduced mobility patients
- High frequency generator and flat panel detectors for a superior image quality
- Arm lock and autobrake system for a safe transportation
- Fully-integrated interface to control both manual and automatic exposure settings
- Advanced components and image processing software for dose reduction

Intermedical · Compact DR Plus

Power 32 kW	Width 57.6 cm	Weight 412 kg
----------------	------------------	------------------



Highlights

- Motorized mobile unit, battery powered, easy to handle and operate
- Telescopic arm
  - Wide choice of available detectors
  - Full DICOM connectivity
  - 19" touchscreen user friendly interface
  - Available in analogue version as well
  - 40 kW version available both analogue and digital

**Mobile DR**

Canon · Mobirex+		
Power	Width	Weight
32/ 40/ 50 kW	54 cm	520 kg

**Highlights**

- New ultra-compact design
- Power assisted, pressure sensitive steering
- Telescopic column
- 19-inch multi-Touch supported display
- Additional 8-inch tube-head display
- Collimator features an LED bulb, laser alignment markers for SID accuracy, and selectable copper filtration
- Secondary drive controls on the collimator
- Equipped with front bumper proximity sensors



- ID card login capability for CXDI Control Software NE
- LED status indicator light

Canon · Mobirex i9		
Power	Width	Weight
32 kW	56 cm	440 kg

**Highlights**

- Motorized assist for easy moving including inch mover buttons
- True 32 kW generator power
- Telescopic column
- 19-inch Multi-Touch supported display
- Remote control options
- DAP integration including RDSR
- Multiple types of Canon detectors available
- Scatter correction
- Advanced Edge Enhancement
- Full DICOM
- Wi-Fi support for PACS and RIS connection



Del Medical · MDR		
Power	Width	Weight
40 kW	57.6 cm	435 kg

**Highlights**

- Affordable all-in-one mobile digital radiography solution
- Compact design with fully collapsible column
- Fully integrated DELWORKS DR workstation with choice of detectors
- Effortless maneuverability, allowing navigation through tight spaces
- Motor assisted inching from the tube head
- On board detector charging



- Convenient storage for wireless detector, grids batteries, wipes, and lead apron
- 35 × 43 cm / 24 × 30 cm detectors
- Pixel size: 148 μm

# EUROPEAN HOSPITAL

Please visit us at  
[european-hospital.com](http://european-hospital.com)

DRGEM · Topaz		
Power	Width	Weight
32/ 40 kW	—	—

**Highlights**

- System concept: motorized mobile DR system
- Enhanced mobility with touch-sensitive handle
- Optimized image quality with advanced Radmax software
- Safety bumper and brake with LED Indicator
- Wide LCD touch screen
- Storage compartment for detector and other equipment
- Wider coverage of ±325° (Column rotation)
- Remote diagnosis
- Remote control
- Collimator live streaming camera
- Optional AI software available



- Detector type: GOS / CsI
- Detector format: 17 × 17" / 17 × 14", wireless

Examion · X-DRS Mobile Pro 320		
Power	Width	Weight
32 kW	57.6 cm	397 kg

**Highlights**

The X-DR Mobile Pro 320 is a battery powered and motorized X-ray system with detector that meets all the needs of the hospital.

- Comfortable motorized movement
- Swiveling column
- Telescopic arm optional
- DICOM connectivity + WLAN
- kV Range: 40 – 133 kV
- Pixel size: 150 μm / 100 μm



Mobile DR

Konica Minolta · AeroDR X30

Power	Width	Weight
20/32/40/50kW	67cm	530 kg

Highlights

- Fully integrated digital mobile X-ray system
- Completely motorized and very easy to manoeuvre: can be controlled with one hand
- The AeroDR detector can easily be stored and at the same time automatically charged in the bin, even during driving
- 100 percent wireless communication for effortless usage at patient's bedside
- Retractable, telescopic column
- Detector sharing with X-ray rooms



Konica Minolta · AeroDR X10

Power	Width	Weight
32kW	61.8cm	170 kg

Highlights

- Fully integrated digital mobile X-ray system
- The AeroDR detector can easily be stored and at the same time automatically charged in the bin
- 100 percent wireless communication for effortless usage at patient's bedside
- Detector sharing with X-ray rooms



OR Technology · Amadeo M mini

Power	Width	Weight
5 kW	56.5 cm	79 kg

Highlights

The Amadeo M mini enables wireless digital X-rays of the entire body trunk, including thorax, spine, abdomen and pelvis. The device remains usable even in the case of a power interruption. Both the laptop and the detector are stored in a protective housing. The compact X-ray unit is simple and easy to move. Folded together, it is easy to transport and even fits into a station wagon. Steps and uneven terrain are no obstacle. The wheels allow easy 360° rotation when folded, which makes it much easier to handle it.



Shimadzu · MobileDaRt Evolution MX8

Power	Width	Weight
32 kW	56 cm	440 kg

Highlights

- Motor-driven, compact system
- Collapsible column with new Glide View technology
- Easy and advanced operating and safety functions
- High-sensitive, light-weight, durable and water proof FPD generation
- Imaging area: 17 × 17" (43 × 42 cm)  
17 × 14" (43 × 35 cm)  
14 × 11" (35 × 27 cm)
- Multiple wireless FPD connectivity for maximum efficiency
- Image preview in one second



Shimadzu · MobileDaRt Evolution MX8 – Pediatric Version

Power	Width	Weight
32 kW	56 cm	440 kg

Highlights

- High-sensitive wireless FPD type CXDI-810C (CsI, 14 × 11")
- Handling benefit through easy placement, e.g. in standard incubators
- Image preview in one second
- Easy and advanced operating functions
- Energy saving collimator with a bright irradiation field through LEDs
- Fully DICOM compliant
- WLAN connectivity
- mAs Range: 0.32 – 320 mAs



Solutions for tomorrow · !M1 – Powered by Canon DR

Power	Width	Weight
20/32/40 kW	58 cm	324 kg

Highlights

- Setting a new standard in mobile X-ray
- Smallest and lightest
- Battery operating time up to 9 hours
- 10 min charging – 1 hour operation time
- 8 years battery warranty
- Easy to clean
- Ready to use within 10 seconds
- Height and reach adjustable drive handle
- Remote diagnostic handle
- Motorized collapsible column support



**Mobile DR**

Konica Minolta · AeroDR TX		
<b>Power</b> 40 kW – Monoblock	<b>Width</b> 54 cm	<b>Weight</b> 520 kg

**Highlights**

- Motorized, very easy to maneuver
- Retractable, telescopic column
- AeroDR detector technology
- DDR ready
- In-bin charging
- Detector sharing with X-ray rooms
- Antibacterial Carbon SMC cover detector
- Pixel size: 100 m – High Definition



• MIL-STD-810G military drop test certified detectors

Mindray Medical · MobiEye 700 Mobile DR System		
<b>Power</b> 30 kW / 50 kW	<b>Width</b> 47 cm	<b>Weight</b> 370 kg

**Highlights**

- Marvelous mobility with intelligent operation
- Bionic design manipulator with eight high flexible mechanical joints
- Superior power management technology
- Remote motion control and remote exposure control
- 19-inch multiple-touch screen



- Lighter and smaller
- High reliability and compatibility
- Detector auto-charging



KONICA MINOLTA

**WE DELIVER UNIQUE SOLUTIONS FOR DIFFERENT HEALTHCARE NEEDS**



Konica Minolta Business Solutions Europe GmbH  
 Capellaan 65 | 2132 JL Hoofddorp | The Netherlands

Tel: +31 (0) 20 65 84 100  
 Web: [www.konicaminolta.eu/healthcare](http://www.konicaminolta.eu/healthcare)

Mobile DR

**Siemens Healthineers · Mobilett Elara Max**

<b>Power</b> 35 kW	<b>Footprint</b> 127.8 cm (l) × 59.8 cm (w)	<b>Weight</b> Approx. 380 kg
-----------------------	--	---------------------------------



**Highlights**

- High-end, fully digital mobile X-ray system
- Compact system design, easy maneuverability, flexible positioning with the MAXreach arm and consistently high-quality images
- Easy-to-clean design
- Intuitive and fully digital *syngo* FLC workflow, excellent wireless connectivity, virtual workstation and cybersecurity package

- Unlock the potential of your X-ray department with Fleet Level Benefits
- Detector: 35 × 43 cm (MAX wi-D) 24 × 30 cm (MAX mini)

**Stephanix · Movix Series DReam**

<b>Power</b> 20 / 32 / 40 / 50 kW	<b>Width</b> 67 cm	<b>Weight</b> 580 kg
--------------------------------------	-----------------------	-------------------------



**Highlights**

- Compact and light design
- Motorized up to 5 km/h
- Independent from mains, only for batteries loading
- Telescopic column and arm, offering wide range of movements for easy positioning
- X-ray tube with rotating anode, thin dual focal spots and high heat capacity
- Color LCD touch screen 17"
- Same interface as Stephanix RAD rooms, intuitive with unlimited APR

- Shareable solution
- kV Range: Up to 150 kVp
- mAs Range: Up to 500 mAs

**Stephanix · Mobile range**

<b>Power</b> 20 / 32 / 40 kW	<b>Width</b> 54 cm	<b>Weight</b> 520 kg
---------------------------------	-----------------------	-------------------------



**Highlights**

- New ultra-compact and streamlined design
- Motorized up to 5.5 km/h
- Telescopic column and arm, offering wide range of movements for easy positioning
- X-ray tube with rotating anode up to 150 kV, up to 500 mAs independent from mains, only for batteries loading
- Colour LCD touch screen 19"
- Login / identification by badge (option)
- Same interface as Stephanix RAD rooms, intuitive with unlimited APR

- Possibility to share detectors with different Stephanix modalities
- Based on sensitive technology for effortless handling

**Stephanix · Movix 4 / 8 DReam**

<b>Power</b> 4 / 8 kW	<b>Width</b> 78 cm	<b>Weight</b> 87 kg
--------------------------	-----------------------	------------------------



**Highlights**

- Lightweight, less than 90 kg
- Design for in / outdoor operation
- Well-suited for applications at patient bedside, traumatology, paediatrics
- Foldable system easy to store and to transport on field
- Same interface as Stephanix RAD rooms, intuitive with unlimited APR
- Secondary generator control console on monoblock tube head
- Shareable solution
- Up to 125 kV

**Technix · TMB 400 / TMB 400 DR**

<b>Power</b> 40 kW	<b>Width</b> 57.6 cm	<b>Weight</b> 435 kg
-----------------------	-------------------------	-------------------------



**Highlights**

- Battery-motorized unit for easy maneuvering and bedside positioning
- Battery powered X-ray exposures
- Two different versions: analogue and digital
- X-ray Housing
- Compact design with telescopic column
- Fixed or telescopic column versions
- Tube-head controls for positioning adjustment
- 19" touchscreen user interface

- Full DICOM connectivity
- Multiple detectors can be interfaced

**Technix · TMB 320 / TMB 320 DR**

<b>Power</b> 32 kW	<b>Width</b> 57.6 cm	<b>Weight</b> 412 kg
-----------------------	-------------------------	-------------------------



**Highlights**

- Battery-motorized system very easy to drive
- Front bumper to avoid collision
- Exposures are possible without connecting the unit to an external power supply
- Two different versions: analogue and digital
- Fixed or telescopic column versions
- 19" touchscreen monitor
- Full DICOM connectivity
- Wide range of post processing functions
- Multiple detectors can be interfaced



Mobile DR

**Technix · TMS 320 R/TMS 320 RDR**

Power	Width	Weight
32 kW	70 cm	240 kg



**Highlights**

- Light and maneuverable unit
- Efficient positioning at patient's bed thanks to the rotating column
- Available in two versions: TMS320 RDR (digital) and TMS320 R (analogue)
- Available also with fixed column (TMS320 / TMS320 DR)
- Upgradable to DR on the field
- Multiple detectors can be interfaced
- 19" touchscreen user interface
- Full DICOM connectivity

**Villa Sistemi Medicali · Visitor T40 M-DR**

Power	Width	Weight
40 kW	57.6 cm	435 kg



**Highlights**

- Motorized DR mobile unit, battery powered
- Exposures are possible without connecting the unit to an external power supply
- Powerful 40 kW generator for high productivity and performance
- ± 320° rotating column with telescopic arm
- Fine positioning adjustment through tube-head controls
- Frontal bumper with anti-collision function
- 19" LCD touch screen user interface
- Full DICOM connectivity
- Detector size: Up to 43 × 43 cm

**Villa Sistemi Medicali · Visitor T30 C-DR**

Power	Width	Weight
32 kW	61.8 cm	170 kg



**Highlights**

- Compact and lightweight mobile DR unit
- High performance X-ray generator, tubehead with double focal spot (0.8 / 1.3 mm)
- 19" touch screen user interface
- Complete with post-processing tools and DICOM functions
- Detector size: Up to 43 × 43 cm

**Villa Sistemi Medicali · Visitor T30 M-DR**

Power	Width	Weight
32 kW	57.6 cm	412 kg



**Highlights**

- Motorized DR mobile unit, battery powered
- Exposures are possible without connecting the unit to an external power supply
- ± 320° rotating column with telescopic arm
- Fine positioning adjustment through tube-head controls
- Frontal bumper with anti-collision function
- 19" LCD touch screen user interface
- Full DICOM connectivity
- Detector size: Up to 43 × 43 cm

**Villa Sistemi Medicali · Visitor T30 R-DR**

Power	Width	Weight
32 kW	69.5 cm	250 kg



**Highlights**

- Mobile DR unit
- ± 90° rotating arm for flexible positioning of the unit
- High performance X-ray generator, tube-head with double focal spot (0.8 / 1.3 mm)
- 19" touch screen user interface
- Complete with post-processing tools and DICOM functions
- Detector size: Up to 43 × 43 cm

**Portable DR**

**Examion · X-DR Portable**

Size	Detector type	Pixel size
14 × 17"	a-Si / CsI	100 – 150 µm



**Highlights**

- Portable case solutions for emergency X-ray. All functions for acquisition, diagnosis and archiving on a single mobile PC.
- Wireless digital X-ray
- Excellent image quality
- Patient administration with mini-PACS
- Radiological viewer
- Synchronization with stationary image archives (optional)
- Detector size: 14 × 17"
- Pixel size: 100 – 150 µm

Portable DR

OR Technology · Leonardo DR mini II

Size 14 × 17" / 12 × 10"	Detector type CsI	Pixel size 100/120/139/140/154 μm
-----------------------------	----------------------	--------------------------------------



Highlights

At only 8.9 kg, the Leonardo DR mini II is one of the world's lightest portable X-ray case systems. The high-quality plastic processing and the well planned space concept form the basis for a practical case for any outdoor use. The suitcase solution is quickly ready to go and easy to use. All components are integrated in the X-ray case. The 17" laptop can easily be removed from its holder in the case and used as a tablet for presentation purposes. The notebook is equipped with the OR software.

OR Technology · Leonardo DR nano

Size 14 × 17"	Detector type CsI	Pixel size 100/139/154 μm
------------------	----------------------	------------------------------



Highlights

Just sling the lightweight Leonardo DR nano backpack system over your shoulder and head off to your next X-ray examination! The Leonardo consists of only two components: a wireless X-ray detector and a laptop. The system is one of the lightest portable X-ray solutions worldwide. The X-ray unit and detector have a wireless connection to the acquisition and diagnosis software on the laptop.

Villa Sistemi Medicali · ArtPix EZ2GO

Size 35 × 43 cm	Detector type a-Si/ CsI	Pixel size 148 μm
--------------------	----------------------------	----------------------



Highlights

- Plug-and-play solution for immediate upgrade to digital radiography
- Lightweight and portable acquisition system based on Wi-Fi flat panel detector and tablet
- Extreme flexibility and ease of use thanks to wireless connections
- Multi-use solution for shared use with general radiographic systems and mobile units
- Powerful acquisition software complete with post-processing tools and DICOM functions

Mobile X-ray

DRGEM · Jade

Power 4 kW	Operation Mains	Motorized No
---------------	--------------------	-----------------



Highlights

- System concept: Portable radiography system
- Compact and powerful design
- Convenient and intuitive operation
- 110 ~ 240 VAC (Free voltage) input
- 40 ~ 120 kV, 10 ~ 100 mA
- Includes manual collimator
- Four-way control – Main body, control console, remote control and control application (USB interface & Bluetooth)
- Preprogrammed APR data and user-programmable APR
- Simple, collapsible mobile stand with external console
- USB external interface, with Bluetooth or DR interface options

Fujifilm · FDR Xair

Power 4.5 kW	Size 30 × 25 × 14 cm	Weight 3.5 kg
-----------------	-------------------------	------------------



Highlights

- FDR Xair's ultralight compact portable design provides a strong advantage when accessibility to normal medical treatment settings is difficult.
- FDR Xair can provide a portable solution and a high-mobility workflow even in unconventional medical scenes.
- The built-in lithium polymer battery enables up to 100 images in environments where there is no electricity\*.
- Flat-surface design provides easy cleaning and maintenance.
- Fast turn on and user-friendly simple button layout provides an efficient workflow.
- Highly durable LED light source for use in variable environments.

\*depends on the exposure conditions

Intermedical · Compact

Power 32 kW	Operation Mains	Motorized No
----------------	--------------------	-----------------



Highlights

- Mobile system used for diagnosis and X-ray examinations. It allows to perform X-ray on CR or film by setting the most suitable radiological data according to the interested anatomic area
- High handiness allows an easy positioning of the unit close to any patient bed with precise movements thanks to the rotation of the column: ± 90°
- Storage of 36 exams (APR)
- Radiographic technique at two points
- Cassette holder (format 35 × 43 cm) for five cassettes
- Remote control device (optional)
- Possibility to upgrade from analogue to digital version

Mobile X-ray

**Shimadzu · MobileArt eco**

<b>Power</b> 12.5 kW	<b>Operation</b> Mains	<b>Motorized</b> No
-------------------------	---------------------------	------------------------



**Highlights**

- Telescopic arm
- Easy positioning
- Wide coverage
- Compact design
- kV Range: 40 – 125 kV
- mAs Range: 0.32 – 320 mAs

**Shimadzu · MobileArt Evolution MX8\***

<b>Power</b> 32 kW	<b>Operation</b> Battery	<b>Motorized</b> Yes
-----------------------	-----------------------------	-------------------------



**Highlights**

- Motor-driven, compact system with collapsible column for easy positioning
- Easy and advanced operating and safety functions
- Energy saving collimator with a bright irradiation field through LEDs
- kV Range: 40 – 133 kV
- mAs Range: 0.32 – 320 mAs

*\*Product is not available in all countries.*

**Siemens Healthineers · Polymobil Plus**

<b>Power</b> 16 kW / 20 kW	<b>Operation</b> Mains	<b>Motorized</b> No
-------------------------------	---------------------------	------------------------



**Highlights**

- Powerful entry level analog mobile X-ray system
- High image quality due to high power output and a minimum exposure time down to 4 ms
- Easy handling and maneuverability based on a lightweight and compact system design
- High reliability

**Stephanix · Movix Series**

<b>Power</b> 20/ 32/ 40/ 50 kW	<b>Operation</b> Battery / Mains	<b>Motorized</b> Yes
-----------------------------------	-------------------------------------	-------------------------



**Highlights**

- Cost effective solution
- Compactness ensures easy handling
- User-friendly interface with 492 customizable anatomical programmes
- Wide range of procedures
- X-ray tube with rotating anode
- Thin dual focal spots
- High heat capacity
- Short exposure time
- mAs Range: Up to 500 mAs
- kV Range: Up to 150 kV

**SternMed · Xenox M80**

<b>Power</b> 15/ 30 kW	<b>Operation</b> Mains	<b>Motorized</b> No
---------------------------	---------------------------	------------------------



**Highlights**

- Rotating anode with 3.000 rpm (optional 10.000 rpm)
- 14× 17" Rad field
- Medical tablet with lockable docking station
- Touch screen 10.4" TFT display
- Collimator with white light LED
- Fieldpositioning and pediatric filter
- Big rear wheels ø 25 cm
- Manual driven
- Dead-Man brake system
- kV Range: 125 kV
- mAs Range: 0.1 to 125 mAs

**Villa Sistemi Medicali · Visitor T30M**

<b>Power</b> 32 kW	<b>Operation</b> Battery	<b>Motorized</b> Yes
-----------------------	-----------------------------	-------------------------



**Highlights**

- Motorized mobile unit, battery powered
- Exposures are possible without connecting the unit to an external power supply
- Compact structure and flexible positioning
- ± 320° rotating column with telescopic arm
- Fine positioning adjustment through tube-head controls
- Frontal bumper with anti-collision function
- kV Range: 40 – 125 kV
- mAs Range: 0.1 – 320 mAs

Mobile X-ray

Villa Sistemi Medicali · Visitor T30R

Power 32 kW	Operation Mains	Motorized No
----------------	--------------------	-----------------



Highlights

- Mobile unit designed for intensive care units as well as orthopedics, pediatric or surgery departments
- Compact design for a high maneuverability of the unit
- ± 90° arm rotation for increased flexibility of X-ray tube positioning
- APR anatomic mode
- User friendly control panel
- High performance generator and double focal spot (0.8 / 1.3 mm) tubehead
- kV Range: 40 – 125 kV
- mAs Range: 0.1 – 220 mAs

Villa Sistemi Medicali · Visitor T4

Power 4 kW	Operation Mains	Motorized No
---------------	--------------------	-----------------



Highlights

- Cost-effective mobile unit granting compactness and ease of use
- Suitable for most examinations performed in plaster rooms and health screenings contexts
- Compact and lightweight design for easy handling
- kV Range: 40 – 110 kV
- mAs Range: 0.2 – 250 mAs

Villa Sistemi Medicali · Visitor T30C

Power 32 kW	Operation Mains	Motorized No
----------------	--------------------	-----------------



Highlights

- Mobile unit designed for intensive care units as well as orthopedics, pediatric or surgery departments
- Compact and lightweight design for a high maneuverability of the unit
- High performance generator and double focal spot (0.8 / 1.3 mm) tubehead
- APR anatomic mode
- User friendly control panel
- kV Range: 40 – 125 kV
- mAs Range: 0.1 – 220 mAs

DXA

Hologic · Horizon DXA system

Detector HR ceramic detector	System Dual X-ray source	Scan method Single-sweep scanning
---------------------------------	-----------------------------	--------------------------------------



Highlights

The Horizon DXA platform is designed to help healthcare professionals in managing Osteoporosis, Obesity and Cardiovascular diseases. Less than 15 s for Hip and Spine BMD, 20 s for VFA, 3 min Whole Body and 20 s atypical femur fracture detection. High Res imaging with ceramic detectors. A dynamic Calibration for greater long-term measurement stability. Advanced networking and reporting capabilities.

Business Intelligence

Siemens Healthineers · teamplay X-ray Dashboard



Highlights

- teamplay X-ray Dashboard\* brings transparency to image rejections and EXI (Exposure Index) of your radiography examinations, helping you to increase quality of X-ray imaging and the operational efficiency of your fleet.
- Track and document your institution's rejection rate for quality control and regulatory requirements
  - Conduct in-depth rejection analysis on various levels, ranging from reject reasons to clinical protocols
  - Monitor under- or overexposure of X-ray images with Exposure Index (EXI) and Deviation Index (DI)

\* teamplay is not commercially available in all countries. If the services are not marketed in countries due to regulatory or other reasons, the service offering cannot be guaranteed.

Accessories / Complementary Systems

Agfa · Smart XR



Highlights

X-ray intelligence at work. Agfa's SmartXR Assistant helps you by lightening your workload and providing image acquisition support. From aligning the panel, to positioning the patient, to setting the precise dose and beyond, SmartXR gives you a helping hand that guides you to greater operational and clinical performance. All while keeping you in control, at every moment.

Accessories / Complementary Systems

Canon Electron Tubes & Devices · XRR-3332X



**Highlights**

- 3 inch ROTANODE X-ray tube assembly for Mobile systems
- 20 percent smaller size / 22 percent lighter weight housing than previous model
- High power input: 46 kW / 20 kW (0.1 s)
- XRR-3332X is useful for designing smaller and excellent mobile system.
- Adopt large capacity anode target to support multipurpose diagnostic application
- Size: 1.2 / 0.6
- Power: 46 kW / 20 kW
- Capacity: 300 kHU (anode heat content) 870W (anode heat dissipation)

Canon Electron Tubes & Devices · XRR-6653X



**Highlights**

- 4" ROTANODE X-ray tube assembly for DR systems
- 20 percent smaller housing than previous model
- Can be used as a replacement part for similar models
- Size: 0.8 / 0.3 (focal spot)
- Power: 52 kW / 12 kW (input power)
- Capacity: 600 kHU (anode heat content) 1,670 W (anode heat dissipation)
- High throughput (500 W continuous anode input power)
- High resolution image with small focal spot size

Canon Electron Tubes & Devices · XRR-4631G



**Highlights**

- 4 inch ROTANODE X-ray tube assembly for DR systems
- 20 percent smaller housing than previous model
- Can be used as a replacement part for similar models
- High power input: 100 kW / 40 kW (0.1 s)
- High cooling rate provided by housing
- Size: 1.2 / 0.6 (focal spot)
- Power: 100 kW / 40 kW (max rating)
- Capacity: 400 kHU (anode heat content) 1,200 W (anode heat dissipation)

Canon · OrthoMod 3D



**Highlights**

- One platform, one software application
- Optical orthopedic image acquisition & fusion
- 3D reconstruction & spine analysis in weight-bearing position
- Based on optical & X-ray data fusion
- Innovating and unique combination of the spine with the back surface

DRGEM · Mobile DR Imaging System for Chest and Chiropractic

<b>Power</b> 32 / 40 / 52 kW	<b>Detector type</b> GOS / CsI, 17×17" / 17×14", wired / wireless
---------------------------------	--



**Highlights**

- System concept: compact radiography system for mobile RAD room
- Mobile imaging radiography system
- Motorized vertical synchronization with wall stand
- Image stitching for whole body
- Auto numbering function with barcode scanner available
- UPS or capacitor generator is recommended
- Optional AI software available

DRGEM · GXR Series – X-Ray Generator

<b>Standard</b> 32 / 40 / 52 / 68 / 82 kW	<b>Capacitor</b> 32 / 40 / 52 kW	<b>UPS</b> 32 / 40 kW
--	-------------------------------------	--------------------------

**Highlights**

- High-frequency generator, perfect for general radiography
- Excellent reproducibility, accuracy, and linearity
- Smaller, lighter modular design
- 1.280 APR conditions with APR utility software
- Tube overloading and housing overheating protection
- Real-time monitoring and self-diagnosis
- Remote diagnosis and automatic calibration
- Adaptive calibration for long-term usage
- Capacitor type: compatible with standard wall outlet



- UPS type: 800 W, free-voltage (100 ~ 240 VAC) line power
- UPS Type: operation time of up to 12 hours and 3,500 X-ray shots during a power failure

Accessories / Complementary Systems

Examion · X-Emergency



Highlights

- Customized container for digital X-ray.
- U-Arm or Z-Arm design. Z-Arm allows lateral exposures on lying patients
- Low maintenance effort
- Excellent image quality
- Patient administration
- Mini-PACS or connection to central archives
- Radiological viewer
- Power: 50 kW
- System concept: Wireless or wired
- Detector size: 14 × 17" / 17 × 17"
- Pixel size: 100 – 150 µm

I.A.E. · RTC 600



Highlights

- Rotating anode graphite X-ray tube, specifically designed for remote controlled table and digital systems
- Enhanced anode heat dissipation, provided by high emittance coating and target design
- Severe tests during conditioning assure reliable performances
- High anode heat storage for repeated loading
- Ground glass window for consistent HVL
- Variety of housings allows flexible systems configurations

I.A.E. · C20



Highlights

- A new compact lightweight housing, specifically designed for mobile equipment.
- A low weight, less than 8.5 kg, combined with compact dimensions, 116 mm diameter and 342 mm length, allows significant reductions in the equipment supporting structures.
- A range of tube inserts up to 54 kW peak radiographic power at high rotation speed is available for this unit.

I.A.E. · C31-RTM 72

- Size 0.6 / 1.2
- Power 30 kW / 75 kW
- Capacity 300 kHU (Anode heat capacity) 500 W (Anode heat dissipation)



Highlights

- Rotating anode X-ray tube unit for mobile x-ray equipment with film and digital detectors
- Lead lined aluminium body
- H.T. cable sockets: type MINI75 4 pin
- Storage and shipment temperature range -10°C / +80°C
- Optional mounting plate for tilting brackets

PTW · Diamentor RS-KDK, RS and C-RS DAP Systems



Highlights

- Integrated DAP chamber and electronics housing (Diamentor RS-KDK, RS)
- Automatic air density correction
- Wireless data transfer with optional Diamentor BT interface
- Simultaneous measurements of DAP and dose units as well as of the exposure time (Diamentor RS-KDK)
- Optional RS-D display unit
- Available with RS232 or RS485 interface

PTW · Normi RAD / FLU – X-Ray Test Object

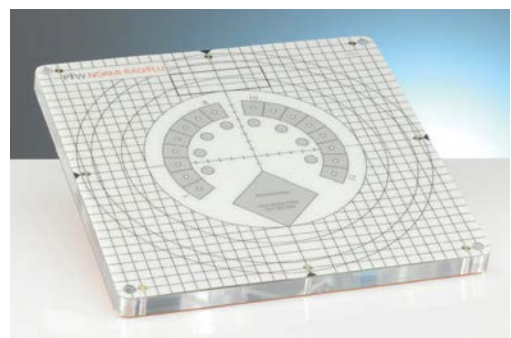

Highlights

- Checks all relevant parameters of fluoroscopic and radiographic X-ray units
- Suitable for routine quality checks on over/under couch tubes and C arms
- Includes an attenuation plate for patient simulation
- Complies with DIN 6868-4 and 6868-150
- Available with the outer format of 300 × 300 mm or 200 × 200 mm

# Molecular Imaging

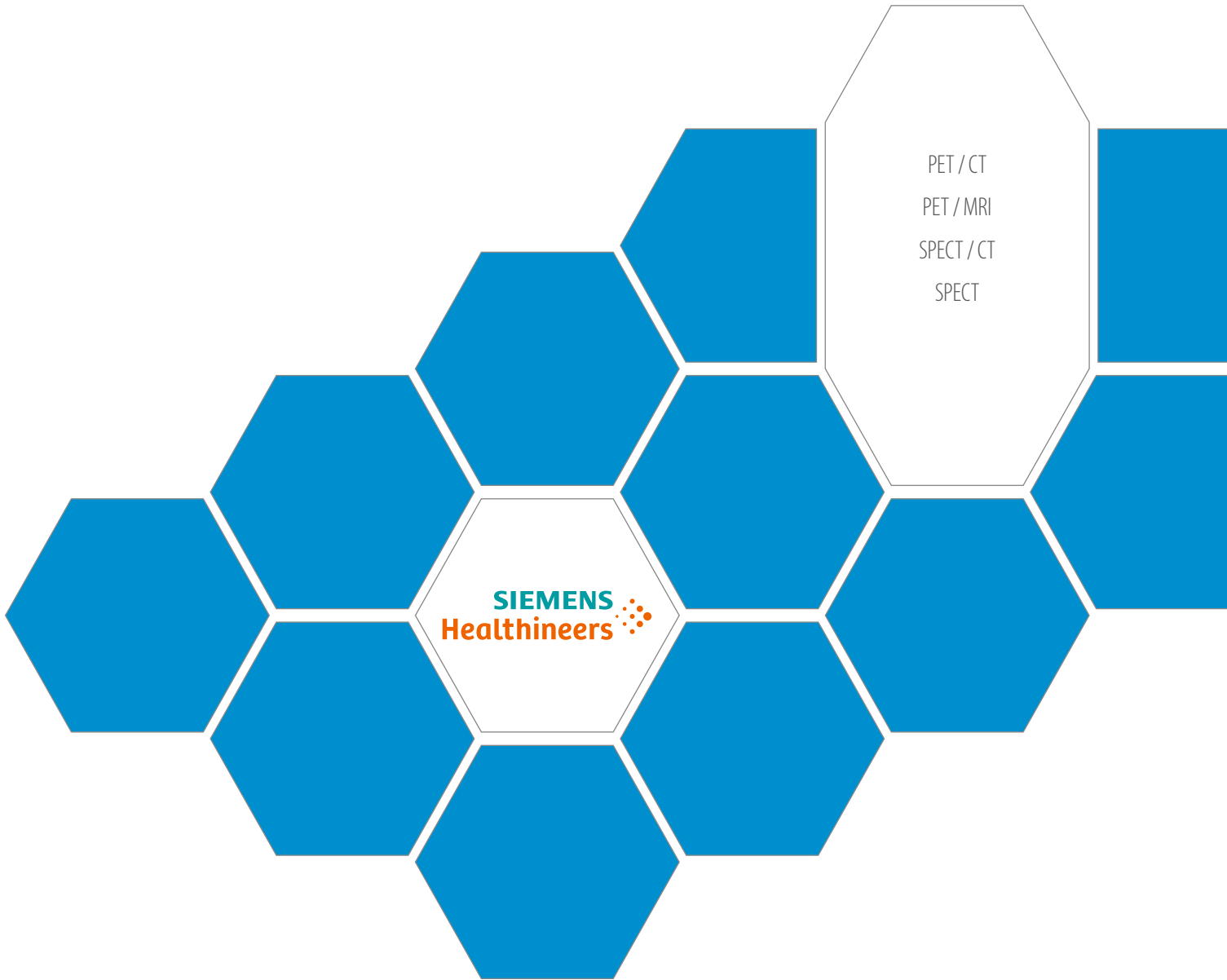

# RADBOOK 2022

Please visit us at  
**healthcare-in-europe.com**

PET/CT

Siemens Healthineers · Biograph Vision Quadra\*

System sensitivity	Energy resolution (NEMA)	Field of view
—	—	106 cm (axial)



Highlights

- 4 × axial PET field of view\*\*
- 106 cm axial PET field of view
- 3.2 mm LSO crystals
- 100 percent sensor coverage
- Fast time of flight at 228 ps
- Highest effective sensitivity of 1,000 cps/kBq\*\*\*
- Designed to fit in the room size of traditional PET/CT scanners

\* Biograph Vision Quadra is not commercially available in all countries. Its future availability cannot be guaranteed. Please contact your local Siemens Healthineers organization for further details.

\*\* Compared to the Biograph Vision 600 PET/CT

\*\*\* Compared to current state-of-the-art technologies. Data on file.

Siemens Healthineers · Biograph Vision\*

System sensitivity	Energy resolution (NEMA)	Field of view
—	—	Up to 263 mm (axial)



Highlights

- Gantry opening: 78 cm
- Volumetric resolution: 51 mm<sup>3</sup>
- 3.2 mm LSO crystals
- Fast time of flight at 214 ps\*\*
- High effective sensitivity at 100 cps/kBq\*\*
- 100 percent sensor coverage

\* Biograph Vision is not commercially available in all countries. Its future availability cannot be guaranteed. Please contact your local Siemens Healthineers organization for further details.

\*\* Based on internal measurements (resolution and time of flight) for Biograph Vision 600. Data on file.

Siemens Healthineers · Biograph mCT

System sensitivity	Energy resolution (NEMA)	Field of view
—	12% FWHM	Up to 221 mm



Highlights

- Exclusive bed design with zero differential deflection between PET and CT
- Gantry opening: 78 cm
- Spatial resolution (NEMA): 4.2 mm
- 4 mm LSO crystals
- Time of flight
- 40-, 64- or 128-slice CT

Siemens Healthineers · Biograph Horizon

System sensitivity	Energy resolution (NEMA)	Field of view
—	12% FWHM	Up to 221 mm



Highlights

- Exclusive bed design with zero differential deflection between PET and CT
- Spatial resolution (NEMA): 4.2 mm
- 4 mm LSO crystals
- Time of flight
- 16- or 32-slice CT

PET/MR

Siemens Healthineers · Biograph mMR

System sensitivity	Energy resolution (NEMA)	Field of view
—	—	258 mm



Highlights

- Maximize PET/MR
- Benefit from motion-free PET images with MR-based motion compensation beyond gating
- Advance PET attenuation correction with whole-body 5-compartment model including bones and HUGE
- Deliver exceptional quality and speed in PET/MR with the latest MR innovations



SPECT/CT

**Siemens Healthineers · Symbia Intevo**

<b>System sensitivity</b> 202 cpm/ $\mu$ Ci	<b>Energy resolution (NEMA)</b> –	<b>Field of view</b> 533 x 387 mm
--	--------------------------------------	--------------------------------------



**Highlights**

- Higher image resolution enables physicians to distinguish between degenerative disease and cancer
- The first system offering accurate and reproducible SPECT quantification
- Up to 68 percent lower CT dose\* with CARE Dose4D and up to 80 percent lower injected dose\* with IQ-SPECT to reduce patient radiation risk
- Productivity tools and IQ-SPECT save time and can double patient throughput

\* Based on competitive literature available at time of publication. Data on file.

**Siemens Healthineers · Symbia Intevo Excel**

<b>System sensitivity</b> 202 cpm/ $\mu$ Ci	<b>Energy resolution (NEMA)</b> –	<b>Field of view</b> 533 x 387 mm
--	--------------------------------------	--------------------------------------



**Highlights**

- SPECT with integrated CT for attenuation correction and anatomical localization
- Flash 3D enables up to 45 percent higher reconstructed resolution\* than conventional SPECT 3D iterative reconstruction
- Largest CT field-of-view\* enables more accurate localization of localization
- IQ-SPECT enables up to 80 percent lower injected dose\* or shorter imaging time, increasing patient comfort and satisfaction

\* Based on competitive literature available at time of publication. Data on file.

**Siemens Healthineers · Symbia Intevo Bold**

<b>System sensitivity</b> 202 cpm/ $\mu$ Ci	<b>Energy resolution (NEMA)</b> –	<b>Field of view</b> 533 x 387 mm
--	--------------------------------------	--------------------------------------



**Highlights**

- iMAR – Interative Metal Artifact Reduction – shows more details by reducing metal artifacts. iMAR helps you overcome the effects of metal artifacts in challenging exams.
- SAFIRE – Sinogram Affirmed Iterative Reconstruction – reduces radiation dose while maintaining image quality
- IVR – Interleaved Volume Reconstruction – reconstructs up to 32 slices to evaluate small structures
- Dual Energy Scan improves image quality with two sequential spiral scans at different energies

**SPECT**

**Siemens Healthineers · Symbia Evo**

<b>System sensitivity</b> 202 cpm/ $\mu$ Ci	<b>Energy resolution (NEMA)</b> –	<b>Field of view</b> 533 x 387 mm
--	--------------------------------------	--------------------------------------



**Highlights**

- Save up to 50 percent\* more time and potentially double patient throughput with automatic quality control and collimator exchange, as well as ultra-fast cardiac imaging
- Image every patient\*\* and improve patient comfort with a larger bore; a high-capacity, low-height patient bed; and hospital bed imaging capabilities
- Industry-leading\* image quality delivers accurate and reproducible clinical information to support physicians' diagnostic confidence

\* Based on competitive literature available at time of publication. Data on file. \*\* Patients up to 227 kg/550 lb.

**Siemens Healthineers · Symbia Evo Excel**

<b>System sensitivity</b> 202 cpm/ $\mu$ Ci	<b>Energy resolution (NEMA)</b> –	<b>Field of view</b> 533 x 387 mm
--	--------------------------------------	--------------------------------------



**Highlights**

- Smallest\* room size in its class, reducing costs associated with room remodeling and expansion
- Ability to image every patient\*\* and improve patient comfort with a larger bore; a high-capacity, low-height patient bed; and hospital bed imaging capabilities
- Industry-leading\* image quality delivers accurate and reproducible clinical information to support physicians' diagnostic confidence

\* Based on competitive literature available at time of publication. Data on file. \*\* Patients up to 227 kg/550 lb.



**KU**  
GESUNDHEITSMANAGEMENT

Please visit us at  
[ku-gesundheitsmanagement.de](http://ku-gesundheitsmanagement.de)

# Displays / Printers

Displays – Mammo  
Displays – Color  
Displays – Grayscale  
DVD Import  
DVD Burner  
Printers

**AGFA**   
HealthCare

**JVC**



KONICA MINOLTA

 bender gruppe  
medigration

 **nexus | chili**  
imaging & radiology solutions

Displays – Mammo

**JVC · CL-S1200**

Panel size 30.9"	Resolution 4,200×2,800	Max. Luminance 1,200 cd/m <sup>2</sup>
---------------------	---------------------------	---



**Highlights**

- Panel technology: IPS
- 2,000 : 1 contrast ratio
- Auto Text Mode
- Dynamic Gamma
- Front and ambient light sensor
- Remote management and calibration
- Integrated power supply
- DVI and DisplayPort interface

**JVC · MS-S500**

Panel size 21.3"	Resolution 2,048×2,560 / 2,048×7,680	Max. Luminance 3,000 cd/m <sup>2</sup>
---------------------	---	---

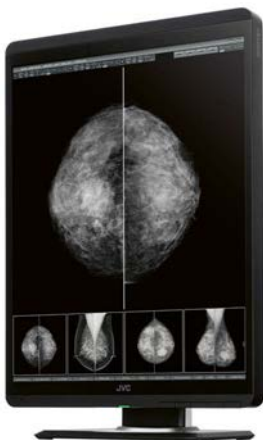

**Highlights**

- LED Backlight
- 2,000 : 1 contrast ratio
- True 11-bit grayscale
- ISD Support
- Front and ambient light sensor
- Remote management and calibration
- Integrated power supply
- DVI and DisplayPort interface

**JVC · CL-S500**

Panel size 21.3"	Resolution 2,048×2,560	Max. Luminance 1,150 cd/m <sup>2</sup>
---------------------	---------------------------	---

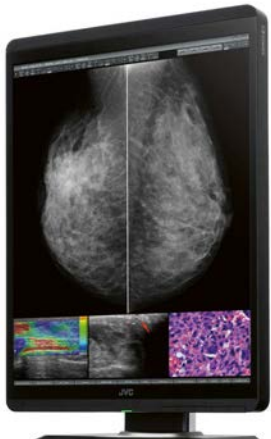

**Highlights**

- Panel technology: IPS
- 2,000 : 1 contrast ratio
- Auto Text Mode
- Dynamic Gamma
- Front and ambient light sensor
- Remote management and calibration
- Integrated power supply
- DVI and DisplayPort interface

**Displays – Color**

**JVC · CL-S600**

Panel size 30"	Resolution 3,280×2,080 (6 MP)	Max. Luminance 1,300 cd/m <sup>2</sup>
-------------------	----------------------------------	---



**Highlights**

- Panel technology: IPS
- 2,000 : 1 contrast ratio
- Brightness stabilization system
- Remote management
- Integrated power supply
- Dual DVI / DisplayPort Input
- Auto Text mode and Dynamic Gamma

**JVC · CL-S200**

Panel size 21.3"	Resolution 1,600×1,200	Max. Luminance 1,000 cd/m <sup>2</sup>
---------------------	---------------------------	---



**Highlights**

- Panel technology: IPS
- 1,200 : 1 contrast ratio
- Front and ambient light sensor
- Remote management and calibration
- Integrated power supply
- DVI and DisplayPort interface
- Optional AR coating
- Auto Text mode and Dynamic Gamma

**JVC · CL-R211**

Panel size 21.3"	Resolution 1,600×1,200	Max. Luminance 500 cd/m <sup>2</sup>
---------------------	---------------------------	---



**Highlights**

- Panel technology: IPS
- 1,800 : 1 contrast ratio
- Front and ambient light sensor
- Remote management and calibration
- Integrated power supply
- DVI and DisplayPort interface
- Optional AR coating
- Auto Text mode and Dynamic Gamma

Displays – Color

JVC · CL-S300

Panel size 21.3"	Resolution 2,048 × 1,536	Max. Luminance 1,000 cd/m <sup>2</sup>
---------------------	-----------------------------	---

Highlights

- Panel technology: IPS
- 1,500:1 contrast ratio
- Front and ambient light sensor
- Remote management and calibration
- Integrated power supply
- DVI and DisplayPort interface
- Optional AR coating
- Auto Text mode and Dynamic Gamma



JVC · CCL196

Panel size 19"	Resolution 1,280 × 1,024	Max. Luminance 800 cd/m <sup>2</sup>
-------------------	-----------------------------	---

Highlights

- Panel technology: IPS
- 1000:1 contrast ratio
- Video and DVI interface
- Brightness stabilization system
- Remote management
- Integrated power supply

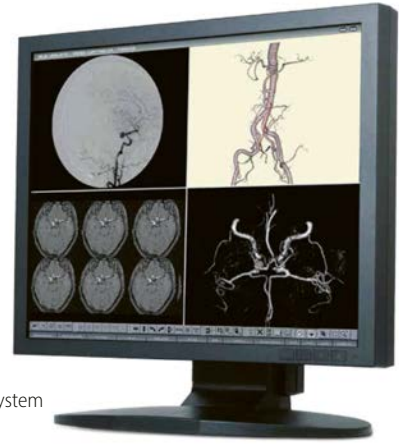

Displays – Grayscale

JVC · MS-S300

Panel size 21.3"	Resolution 1,536 × 2,048 / 1,536 × 6,144	Max. Luminance 3,000 cd/m <sup>2</sup>
---------------------	---	---

Highlights

- Panel technology: IPS
- 2,000:1 contrast ratio
- True 11-bit grayscale
- ISD Support
- Front and ambient light sensor
- Remote management and calibration
- Integrated power supply
- DVI and DisplayPort interface
- LED Backlight



JVC · MS-S200

Panel size 21.3"	Resolution 1,600 × 1,200 / 4,800 × 1,200	Max. Luminance 1,900 cd/m <sup>2</sup>
---------------------	---	---

Highlights

- Panel Technology: IPS
- 1,800:1 contrast ratio
- True 11-bit grayscale
- ISD Support
- Front and ambient light sensor
- Remote management and calibration
- Integrated power supply
- DVI and DisplayPort interface
- LED Backlight

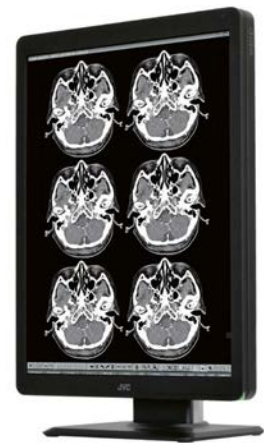

JVC · ME195

Panel size 19.1"	Resolution 1,280 × 1,024	Max. Luminance 1,400 cd/m <sup>2</sup>
---------------------	-----------------------------	---

Highlights

- Panel technology: IPS
- 1,000:1 contrast ratio
- Brightness stabilization
- DVI and Video input to connect modality systems



DVD Import

Nexus / Chili · Import Robot

Highlights

- Automatic import robot
- Import of patient CD / DVD
- 2, 5 or 10 drives
- 2 import trays (regular / express)
- 2 output trays (ok, failed)
- Optional virus scan
- Correction of foreign data
- Automatic DICOM transfer
- Works with any PACS



DVD Burner

medigation · CD-Imager



Highlights

- Fully automatic compact system for creating DICOM patient CDs or DVDs
- Highly compatible with all digital DICOM modalities (multimodality)
- Individual labeling (practice / clinic logo)
- Easy integration of DICOM patient data
- Extremely cost effective due to quick printing times and low link consumption
- Format: CD-R, DVD-R, DVD+R, DVD-R DL, DVD+R DL
- Capacity: 30 CDs / h or 15 DVDs / h (burn and print)
- Magazine size: 2 x 50 pcs

Nexus/Chili · Burn Gateway



Highlights

- Receives data by DICOM C-Store
- Burns data on one or more CD / DVDs
- Optional reports
- Individual label printing
- Client enabled (different logos)
- CHILL viewer in report quality
- Alternative presentation as HTML and JPEG
- Certified by OFFIS and DRG
- Works with any PACS
- External output tray

Printers

Agfa · Drystar Axys

Technology	Capacity	Resolution
Direct digital imaging	75 films / h (14x17)	508 dpi



Highlights

- Flexible, tabletop imager delivering mammography-quality images
- Multi-application hardcopy solution, including digital mammography
- Integrated A#Sharp technology for optimized image quality
- Two multi-format trays, each supporting different film sizes and types
- Very short access time for extremely fast delivery of first four prints

Agfa · Drystar 5503

Technology	Capacity	Resolution
Direct digital imaging	100 films / h (14x17)	508 dpi



Highlights

- Multi-modality, high throughput imager with film sorter
- Ideal for centralized workflow, can easily be connected to the network
- Integrated A#Sharp technology for optimized image quality
- Three multi-format trays, each supporting different film sizes and types
- Suitable for CT, MRI, DSA, digital R / F, CR, DR and optional mammography applications

Agfa · Drystar 5302

Technology	Capacity	Resolution
Direct digital imaging	75 films / h (14x17)	320 dpi



Highlights

- Suitable for all applications and ideal for CR / DR
- A#Sharp technology for optimized image quality
- Convenient imaging with two media sizes on-line (multi-format)
- Very short access time ensures fast printing of small print jobs

Agfa · Drystar 5301

Technology	Capacity	Resolution
Direct digital imaging	70 films / h (14x17)	320 dpi



Highlights

- A#Sharp Technology
- Direct Digital Imaging Technology
- Excellent reliability, minimum maintenance
- Convenient imaging with one media size online
- Provides excellent quality for low operating cost

Printers

Konica Minolta · DryPro 873

Technology Laser	Capacity 180 films/h	Resolution 530 dpi
---------------------	-------------------------	-----------------------



Highlights

- Fully DICOM compatible
- Ready for up to three film trays
- Optional sorter available
- Fast multi-modality printer for optimal performance
- High density printing for mammography – Dmax 4.0

Konica Minolta · DryPro Sigma II

Technology Laser	Capacity 110 films/h	Resolution 508 dpi
---------------------	-------------------------	-----------------------



Highlights

- Compact laser imager
- Fastest time for first film print out (50 s)
- Ready for up to two film trays
- Support of five different film sizes

Konica Minolta · DryPro Sigma I

Technology Laser	Capacity 90 films/h	Resolution 78 µm
---------------------	------------------------	---------------------



Highlights

- Single tray
- Support of four film sizes
- Easy film loading process

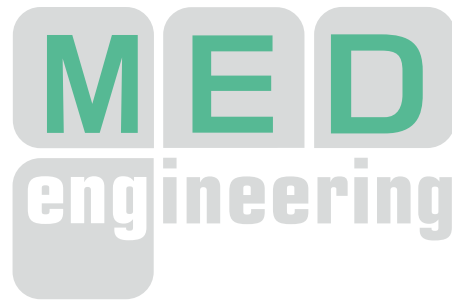

Please visit us at

[med-eng.de](http://med-eng.de)

# Ultrasound

**Canon**

**FUJIFILM**

**HOLOGIC**  
The Science of Sure

**STERNMED**  
we make it possible



**KONICA MINOLTA**

**mindray**

**SIEMENS**  
**Healthineers**

**Canon · Aplio i800 Prism Edition**

Frequency range 1–33 MHz	Display mode 2D/3D/4D	Display size 23"
-----------------------------	--------------------------	---------------------

**Highlights**

- Intelligent Dynamic Micro Slice, iBeam, Precision Imaging, ApliPure+, Differential THI, TSO, ADF, Intelligent Superb Micro Vascular Imaging, Ultra High Frequency
- CEUS; Advanced CEUS incl. VRI, MicroFlow imaging, Quad View
- 4D (surface, MPR, MultiView, Luminance, Shadow Glass)
- FlyThru virtual endoscopy, Smart Fusion, Strain and Quad View Shear-wave elastography Dispersion Imaging, Attenuation Imaging, MicroPure, Auto IMT, RADS, prostate fusion, breast scan guide



**Canon · Aplio i700 Prism Edition**

Frequency range 1–24 MHz	Display mode 2D/3D/4D	Display size 23"
-----------------------------	--------------------------	---------------------

**Highlights**

- Intelligent Dynamic Micro Slice, iBeam, Precision Imaging, ApliPure+, Differential THI, TSO, ADF, Intelligent Superb Micro Vascular Imaging
- CEUS; Advanced CEUS incl. VRI, MicroFlow imaging, Quad View
- 4D (surface, MPR, MultiView, Luminance, Shadow Glass)
- FlyThru virtual endoscopy, Smart Fusion, Strain and Quad View Shear-wave elastography, Dispersion Imaging, Attenuation Imaging, MicroPure, Auto IMT, RADS, prostate fusion, breast scan guide



**Canon · Aplio a550**

Frequency range 1,5 – 18 MHz	Display mode 2D/3D/4D	Display size 23"
---------------------------------	--------------------------	---------------------

**Highlights**

- aBeam, Precision Imaging, ApliPure+, Differential THI, TSO, ADF, Intelligent Superb Micro Vascular Imaging, Doppler Luminance, matrix technology
- CEUS; Advanced CEUS incl. VRI, MicroFlow imaging and CEUS quantification
- 4D (surface, MPR, MultiView, Luminance, Shadow Glass)
- FlyThru virtual endoscopy, Smart Fusion, Strain and Shearwave elastography, MicroPure, Auto IMT, AUTO NT, Wall Motion Tracking



**Canon · Aplio a**

Frequency range 1,8 – 18 MHz	Display mode 2D/3D/4D	Display size 23"
---------------------------------	--------------------------	---------------------

**Highlights**

- aBeam, Precision Imaging, ApliPure+, Differential THI, TSO, ADF, Intelligent Superb Micro Vascular Imaging, Doppler Luminance, Matrix technology
- CEUS; Advanced CEUS incl. VRI, MicroFlow imaging
- 4D (surface, MPR, MultiView, Luminance)
- Smart Fusion, Strain and Shear-wave elastography, Attenuation Imaging, MicroPure, Auto IMT, RADS, prostate fusion, WMT, breast scan guide



**Canon · Aplio a450**

Frequency range 1,8–18 MHz	Display mode 2D/3D/4D	Display size 21.5"
-------------------------------	--------------------------	-----------------------

**Highlights**

- aBeam, Precision Imaging, ApliPure+, Differential THI, TSO, ADF, Superb Micro Vascular Imaging, Doppler Luminance
- CEUS; Advanced CEUS incl. VRI, MicroFlow imaging
- 4D (surface, MPR, MultiView, Luminance)
- Smart Fusion, Strain and Shearwave elastography, MicroPure, Auto IMT, AUTO NT, Wall Motion Tracking



**Canon · Xario 200G**

Frequency range 1.8–18 MHz	Display mode 2D/3D/4D	Display size 21.5"
-------------------------------	--------------------------	-----------------------

**Highlights**

- Up to eight hours battery autonomy, two seconds startup from standby, 21.5 inch wide screen display
- High Density Beamformer, Precision Imaging, ApliPure+, Differential THI, Tissue Enhancement, Advanced Dynamic Flow, Superb Microvascular Imaging (SMI)
- 4D-imaging; SR, MPR, MultiView, Freehand 3D, Luminance
- Shearwave elastography with propagation map, strain elasto, Auto IMT, Stress Echo, 2D Wall Motion Tracking, CEUS contrast imaging, Point of Care Ultrasound applications
- iStyle+ productivity suite with fully customizable panel, agile housing, height adjustable console, panel swivel, Quick Start, Quick Scan & Quick Assist, Extensive line-up of transducers





# Canon



## A higher definition of imaging

iBeam+ is the next level in ultra-fast, precise beam shaping available on Aplio i-series / Prism Edition. With enhanced depth and detail, it can help you achieve more robust results and greater clinical confidence – especially with difficult-to-scan patients.

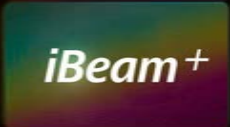

**iBeam+**

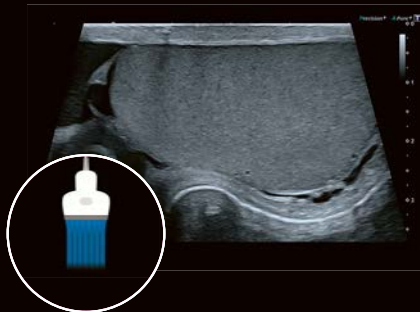

### Improved uniformity

Full Focus enables clear, uniform images without the need for adjustments.



### Enhanced penetration

Improved depth and detail resolution allow easier access in difficult-to-scan cases.

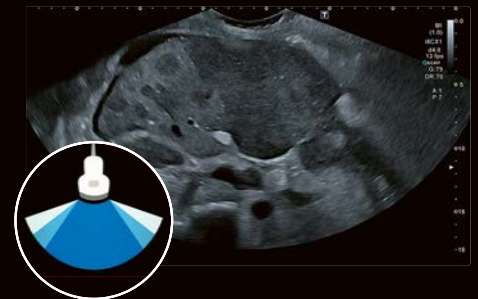

### Ultra Wide View

Expand the field of view while maintaining excellent image quality and frame rate throughout.

CANON MEDICAL SYSTEMS EUROPE B.V.

<https://eu.medical.canon>

*Made For life*

Canon · Xario 100G

Frequency range	Display mode	Display size
1.8–18 MHz	2D/3D/4D	21.5"

**Highlights**

- Up to 4 hours battery autonomy, two seconds startup from standby, 21.5 inch wide screen display
- High Density Beamformer, Precision Imaging, ApliPure+, Differential THI, Tissue Enhancement, Advanced Dynamic Flow
- 4D-imaging; surface rendering, MPR, MultiView, Freehand 3D, Luminance
- Realtime elastography, Auto IMT, Stress Echo, Point of Care Ultrasound applications
- iStyle+ productivity suite with fully customizable panel, agile housing, height selectable console, Quick Start, Quick Scan & Quick Assist, Extensive line-up of transducers



Canon · Viamo sv7

Frequency range	Display mode	Display size
1.5–12 MHz	2D	12.3"

**Highlights**

- Portable ultrasound system
- Multi touch screen, tablet mode possible
- Single transducer input, expandable to three transducers
- Battery and AC operation, very fast boot time (< 10 s from standby to scanning), three hours battery support
- High colour sensitivity, exceptional image quality
- Highly programmable Touch Screen, few buttons, easy to operate, protocol assist. D-THI. Precision Plus, Aplipure+, Cardiac measurement kit and OB measurement package kit are pre-installed
- Point of Care Ultrasound applications, General Imaging, Sports Medicine, MSK, Home healthcare



Fujifilm · Arietta 850SE

Frequency range	Display mode	Display size
1–22 MHz	3D/4D	23"

**Highlights**

- Multi-disciplinary Premium platform, ergonomic design
- Pure Image Symphonic Architecture
- 23" LCD monitor for highest contrast
- Wide range of transducers for GI, interventional guidance, urology and TEE applications, CMUT
- Advanced modalities: SWM, ATT, Real-time Elastography, Combi-Elasto, CEUS, RVS Fusion, Needle and Body Motion tracking, 3D/4D
- Advanced analysis: TIC, eTracking, WI, 2DTT, Protocol assistant, Auto Measurements



Fujifilm · Arietta 850

Frequency range	Display mode	Display size
1–22 MHz	3D/4D	22"

**Highlights**

- Multi-disciplinary Premium platform, ergonomic design
- Pure Image Symphonic Architecture
- 22" OLED monitor for highest contrast
- Wide range of transducers for GI, interventional guidance, urology and TEE applications, CMUT
- Advanced modalities: SWM, ATT, Real-time Elastography, Combi-Elasto, CEUS, RVS Fusion, 3D SIM navigator, E-field Simulator, Needle and Body Motion tracking, 3D/4D
- Advanced analysis: TIC, eTracking, WI, 2DTT, Protocol assistant, Auto Measurements



Fujifilm · Arietta 750

Frequency range	Display mode	Display size
1–18 MHz	3D/4D	23"

**Highlights**

- Multi-disciplinary Premium platform, ergonomic design
- Pure Image Symphonic Architecture
- 23" monitor for highest contrast
- Wide range of transducers for GI, interventional guidance, urology and TEE applications
- Advanced modalities: SWM, ATT, Real-time Elastography, CEUS, Combi-Elasto, RVS Fusion, Needle and Body Motion tracking, 3D/4D
- Advanced analysis: TIC, eTracking, WI, 2DTT, Protocol assistant, Auto Measurements



**RADBOOK 2022**

Please visit us at  
**healthcare-in-europe.com**

**Fujifilm · Arietta 65**

Frequency range 1 – 18 MHz	Display mode 3D/4D	Display size 21.5"
-------------------------------	-----------------------	-----------------------

**Highlights**

- Compact multi-disciplinary platform with comfortable workflow, high definition imaging and useful application from premium platform
- Automated process features: Protocol Assistant, Auto-Optimizer, Auto Measurement
- Battery
- Unique image processing technology underpin outstanding image quality
- 21.5" LCD Widescreen Monitor, fully articulating monitor arm
- Wide range of transducers for GI, urology and TEE applications
- Advanced modalities & analysis: SWM, ATT, 3D/4D Dual gate Doppler, Strain Elastography, CEUS, 2DTT



**Fujifilm · Arietta 50**

Frequency range 1 – 18 MHz	Display mode 2D	Display size 21"
-------------------------------	--------------------	---------------------

**Highlights**

- Lightweight compact multi-disciplinary platform with intuitive workflow, clear imaging, and easy-to-use applications
- Automated process features: Auto Optimizer, Doppler auto trace, Automated Measurement (IMT, NT)
- Simplified and user-friendly interface
- Battery
- Unique image processing technology underpin outstanding image quality
- Widescreen 21" LCD monitor
- Wide range of transducers
- Advanced modalities: CEUS



**Hologic · SuperSonic Mach 30**

Frequency range 1 – 20 MHz	Display mode 3D	Display size 23"
-------------------------------	--------------------	---------------------

**Highlights**

SuperSonic MACH 30 ultrasound system with UltraFast Imaging is designed to help increase efficiency and diagnostic accuracy. The system features innovative imaging modes useful in many general imaging applications. Pioneer in elastography, our ShearWave PLUS provides tissue stiffness evaluation in real time and 3D imaging. It is equipped with intuitive SonicPad touch-pad, designed to reduce examination time and operator fatigue.



Please visit us at [ku-gesundheitsmanagement.de](http://ku-gesundheitsmanagement.de)

**Konica Minolta · Sonimage HS2**

Frequency range Up to 18 MHz	Display mode 2D (BW / color) and TAM	Display size 15"
---------------------------------	---	---------------------

**Highlights**

- Premium portable ultrasound
- Real 18 MHz imaging
- 3THI – Triad Tissue Harmonic Imaging
- iXRet-technology
- Sonimage UI concept
- SNV Technology – Simple Needle Visualization
- Startup from standby in 15 sec
- Excellent solution for radiology and MSK specialists, rheumatologists, anesthesiologists and intensivists, vascular specialists



**Konica Minolta · Sonimage MX1**

Frequency range Up to 14 MHz	Display mode 2D (BW / color) and TAM	Display size 12.1"
---------------------------------	---	-----------------------

**Highlights**

- Real point-of-care ultrasound
- Dual sonic technology
- iXRet-technology
- Sonimage UI concept
- One-touch image optimization for quick operation
- SNV technology – Simple Needle Visualization
- Up to 2H operation
- Weight: 4.5 kg (incl. battery)
- Tailored solution for MSK specialists, rheumatologists, anesthesiologists and intensivists, vascular specialists



**Mindray Medical · Consona N Serie**

Frequency range –	Display mode 3D/4D	Display size 21.5" – 23.8"
----------------------	-----------------------	-------------------------------

**Highlights**

- A New era of Primary Care Ultrasound
  - Powered by ZST+ Premium technology
  - New ultrasound workhorse system
  - Fully loaded with high efficiency applications and performance at value Price
  - Outstanding GI/ Shared Service, OB and also CV images
  - Single Crystal + combo wave phased array transducer
  - Smart tools such as 3D/4D Smart Scene 3D and Smart OB
  - Advanced Applications, like UWN+ CEUS and Smart Thyroid/Breast analysis with Best in class shear wave STE Elastography
  - Large touch screen (13.3" to 15.6") & Full HD monitor (21.5" to 23.8"), with 4 to 5 active sockets
- Come and Experience Consona at ECR 2022!



**Mindray Medical · Resona I9**

Frequency range 1 – 20 MHz	Display mode 3D/4D	Display size 23.8"
-------------------------------	-----------------------	-----------------------

**Highlights**

- ZST+ platform
- Full-space floating control panel
- iConsole intelligent control panel
- High frame rate STE
- Smart Thyroid
- Smart Breast



**Mindray Medical · Resona R9**

Frequency range 1 – 23 MHz	Display mode 3D/4D	Display size 21.5"
-------------------------------	-----------------------	-----------------------

**Highlights**

- Advanced ZST+ platform
- A new standard of image clarity for different clinical scenarios
- More advanced tools for confident diagnosis and clinical research: HiFR CEUS, High frame rate STE, uHIT, iFusion, V Flow
- Intelligent tools with more efficiency and accuracy: Smart Breast and Smart HRI



**Mindray Medical · Resona 7**

Frequency range 1 – 20 MHz	Display mode 3D/4D	Display size 21.5"
-------------------------------	-----------------------	-----------------------

**Highlights**

- Powered by ZST+ platform, the next generation ZONE Sonography Technology based on Channel Domain Software processing.
- A premium ultrasound system that helps customers to see more.
- Faster and more accurate images.
- Complete set of tools – V Flow, Fusion Imaging, RIMT and CEUS – for Radiology and clinical research



**Mindray Medical · DC-80A with X-Insight**

Frequency range 1 – 20 MHz	Display mode 3D/4D	Display size 23.8"
-------------------------------	-----------------------	-----------------------

**Highlights**

- Superb 3D/4D with single crystal volume and Hyaline
- Outstanding ABD image in both penetration and resolution
- Most intelligent Smart Planes CNS and Smart Face
- Large touch screen (13.3") & Full HD monitor (23.8"), five active sockets
- Best in class shear wave (STE & STQ)
- Built-in battery for continuous scanning

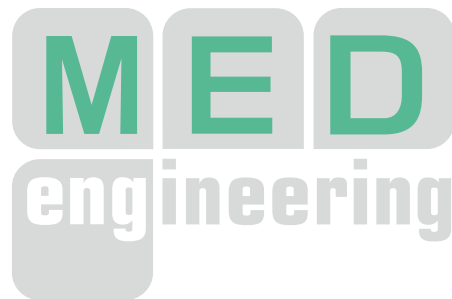

Please visit us at  
[med-eng.de](http://med-eng.de)

# Resona I9

Innovation, in every facet



- iConsole - Intelligent Control Panel
- Intuitive Touch screen
- Excellent Screen experience
- Bedside Exams without Power Cables

## Mindray Medical · DC-70 Exp with X-Insight

Frequency range 1 – 20 MHz	Display mode 3D/4D	Display size 13.3" / 21.5" / 23.8"
-------------------------------	-----------------------	---------------------------------------



### Highlights

- Top in class 3D/4D with single crystal volume and Hyaline
- Best in class ABD image in both penetration and resolution
- Most intelligent Smart Planes CNS and Smart Face
- Largest Full HD monitor (21.5" / 23.8") and ultra-slim touch screen (13.3")

## Mindray Medical · DC-40 with Full HD

Frequency range 1 – 16 MHz	Display mode 3D/4D	Display size 21.5"
-------------------------------	-----------------------	-----------------------



### Highlights

- 21.5" full HD LED monitor with 1,920 × 1,080 resolution
- Upgraded one-key auto image optimization solution
- One-key to switch the exam mode
- Complete features: Smart Face, Smart FLC and IVF application package, Smart V, Smart Track
- Higher compatibility of power supply requirement

## Mindray Medical · M9

Frequency range 1 – 16 MHz	Display mode 3D/4D	Display size 15"
-------------------------------	-----------------------	---------------------



### Highlights

- Advanced premium level laptop style color Doppler offering easy handling and mobility
- Rich in technology such as 3T transducer with single crystal and high dynamic range flow
- Ideal shared-service solution suitable to be used within multiple clinical settings
- Intelligent workflow with iTouch (one key image optimisation)
- User-defined operation to improve work efficiency



### Resona I9

General imaging ultrasound system with completely innovative features from inside out

<https://www.resona7.com/news-ri9.html>

**Mindray Medical · ME8**

Frequency range 1 – 20 MHz	Display mode 3D	Display size 15.6"
-------------------------------	--------------------	-----------------------



**Highlights**

- 15.6" IPS monitor, 12.3" IPS touch screen
- ZST+ platform
- Magnetic power socket
- Contrast Imaging
- Elastography Imaging
- Stress Echo
- Smart Fluid Management Solution
- E-Spatial Navi

**Mindray Medical · MX7**

Frequency range 1 – 20 MHz	Display mode 3D / 4D	Display size 15.6"
-------------------------------	-------------------------	-----------------------



**Highlights**

- 15.6" IPS monitor, 12.3" IPS touch screen
- Cutting-edge ZST+ platform
- Eight hours continuous scanning
- Magnetic power socket
- Contrast imaging
- Elastography imaging
- Stress echo
- TDI and QA
- LVO
- iNeedle+

**Mindray Medical · TE9**

Frequency range 1–23 Mhz	Display mode 3D	Display size 21.5"
-----------------------------	--------------------	-----------------------



**Highlights**

- An exceptional design for an extraordinary experience with its 21.5" full touch screen large image and high definition display for more information with the 38% Smart iZoom larger view.
- Quick and clear diagnoses, equipped with efficiency-boosting features eSpatial Navi, iNeedle+, AutoEF, iZoom, iTouch and Smart Track, Smart VTI, Smart B-Line, SMart IVC and brand new Smart FHR OB1 and Auto GA applications.
- Efficient workflow with three second boot up from standby and swift touch response of settings.
- Easy to transport and store, can be mounted on narrow footprint trolley, desktop table or a wall.

**Mindray Medical · TE7**

Frequency range 1 – 16 MHz	Display mode 3D	Display size 15"
-------------------------------	--------------------	---------------------



**Highlights**

- Touch enabled response providing simple control and setting optimization
- Touch-screen gestures such as pinch to zoom in or out
- Three second boot up from standby and swift touch response of settings
- Equipped with efficiency-boosting features eSpatial Navi, iNeedle+, AutoEF, iZoom, iTouch and Smart Track
- Easy to transport and store, can be mounted on trolley, desktop table or wall

**Siemens Healthineers · Acuson Sequoia Ultrasound System**

Frequency range 1 – 18 MHz	Display mode 2D / 3D / 4D	Display size 15.6" / 22"
-------------------------------	------------------------------	-----------------------------



**Highlights**

- Powered by BioAcoustic imaging technology to reduce the effects of ultrasound variability among users, patients and technology.
- See more: See deeper and clearer with the latest InTune transducers offering InFocus technology eliminating the need for a conventional focal zone
  - Know more: Advanced applications expand clinical information with imaging technologies that improve patient outcomes
  - Do more: User designed experiences that improve workflow usability

**Siemens Healthineers · Acuson Juniper Ultrasound System**

Frequency range 1.1 – 18MHz	Display mode 2D / 3D / 4D	Display size 13.3" / 21.5"
--------------------------------	------------------------------	-------------------------------



**Highlights**

- High-performance, shared-service system for virtually every patient with one of the industry's smallest footprint
- Five active transducer ports and one CW port support 19 transducers for a wide variety of capabilities – from radiology, interventional radiology, cardiology, urology to orthopedics and OB/GYN
- High-fidelity acoustic signals greatly reduce noise and offer premium image quality with industry-leading elasticity solutions

**Siemens Healthineers · Acuson P500 Ultrasound System**

Frequency range 1.3 – 16 MHz	Display mode 2D	Display size 15.4"
---------------------------------	--------------------	-----------------------

**Highlights**

- Innovative technologies that automatically detect and prevent motion artifacts, reduce noise, and simultaneously enhance color
- 15" infrared touch screen improves gesturing accuracy
- Increase patient throughput with mobile quick scanning and boot-up times of less than 30 seconds
- The new IntraCardiac Echocardiography (ICE) Edition integrates the imaging capabilities of the Acuson AcuNav catheters providing real-time visualization of cardiac anatomy within the heart



**Siemens Healthineers · Acuson NX3 Elite Ultrasound System**

Frequency range 1.3 – 16 MHz	Display mode 2D/3D/4D	Display size 10.4" / 21.5"
---------------------------------	--------------------------	-------------------------------

**Highlights**

- Powerful platform driven by efficiency and built for performance.
- Intuitive user interface with up to 28% fewer keystrokes and 3x more user-defined keys
- 21.5" HD display and 220° endo-cavity transducer provides expanded field of view
- 10.4 inch touch display with swipe motion
- Transducer compatibility with existing and legacy Siemens Healthineers systems



**Siemens Healthineers · Acuson NX3 Ultrasound System**

Frequency range 1.3 – 12 MHz	Display mode 2D/3D/4D	Display size 10.4" / 21.5"
---------------------------------	--------------------------	-------------------------------

**Highlights**

- Powerful platform driven by efficiency and built for performance
- Intuitive user interface with up to 28% fewer keystrokes and 3 x more user-defined keys
- 21.5" HD display provides expanded field of view
- 10.4 inch touch display with swipe motion
- Transducer compatibility with existing and legacy Siemens Healthineers systems



**Siemens Healthineers · Acuson NX2 Elite Ultrasound System**

Frequency range 2 – 10 MHz	Display mode 2D	Display size 21.5"
-------------------------------	--------------------	-----------------------

**Highlights**

- Provides premium imaging performance using a cost-efficient, ten-transducer set to perform a wide range of exam types at a sustainable value
- Intuitive control panel design combined with up to four front-facing transducer ports optimize workflow efficiency
- Large 21.5" 1,080 p HD display; Twice the pixel density
- Migrated optional advanced clinical applications such as DTI, eSie Touch elasticity & advanced foursight technology



**Siemens Healthineers · Acuson NX2 Ultrasound System**

Frequency range 2 – 10 MHz	Display mode 2D	Display size 21.5"
-------------------------------	--------------------	-----------------------

**Highlights**

- Provides premium imaging performance using a cost-efficient, eight-transducer set to perform a wide range of exam types at a sustainable value
- Intuitive control panel design combined with up to four front-facing transducer ports optimize workflow efficiency
- Large 21.5" 1,080 p HD display; Twice the pixel density
- Simplified control panel designed to enable operator efficiency and speed-up completion of essential tasks



**Siemens Healthineers · Acuson SC2000 Prime Ultrasound System**

Frequency range 1.25 – 10 MHz	Display mode 2D/3D/4D	Display size 21.5"
----------------------------------	--------------------------	-----------------------

**Highlights**

- The complete structural heart disease solution as the only system to offer 2D and 4D TTE, TEE, and ICE and TrueFusion on one system
- Speed and precision for the echo lab with AI-powered applications: eSie Measure, eSie LVA, eSie Left Heart and eSie Valves
- Advanced applications to support routine echo and interventional guidance with eSie PISA, eSie VVI, Volume Right Ventricular Analysis (RVA), Septal Guide, TrueFusion and more
- One-click automated aortic and mitral valve modeling and measurements within seconds with eSie Valves



Siemens Healthineers · Acuson Redwood Ultrasound System

Frequency range 1 – 18 MHz	Display mode 2D/3D/4D	Display size 13.3" / 21.5"
-------------------------------	--------------------------	-------------------------------

**Highlights**

- Offering detailed image quality, advanced applications and efficient workflow, Acuson Redwood provides an ultrasound solution that is redefined.
- Detailed: See deeper and clearer with the latest InTune transducer family
  - Advanced: Tailored advanced applications that improve patient outcomes
  - Efficient: Small, portable and AI-powered measurement tools for intuitive workflow



Siemens Healthineers · Acuson Freestyle Elite Ultrasound System

Frequency range 2 – 15 MHz	Display mode 2D	Display size 15"
-------------------------------	--------------------	---------------------

**Highlights**

- With cable-free technology to offer unrestricted access to practitioners at the point of care, allowing quicker turnaround time
- Enhanced needle visualization and Pixelformer image processing architecture on an expanded image display may improve procedural confidence in interventional settings
- Automatically populate patient registration data between systems with Artis Patient Synchronization using Artis Access



Siemens Healthineers · Acuson Freestyle Ultrasound System

Frequency range 2 – 15 MHz	Display mode 2D	Display size 15"
-------------------------------	--------------------	---------------------

**Highlights**

- With cable-free technology to offer unrestricted access to practitioners at the point of care, allowing quicker turnaround time
- Enhanced needle visualization and Pixelformer image processing architecture on an expanded image display improve procedural confidence in interventional settings
- Empowered workflow with zero cable-drag and single-user operation via integrated scanning controls



**RADBOOK 2022**

Please visit us at  
**healthcare-in-europe.com**

SternMed · Sonos 10

Frequency range 1,5 – 15 MHz	Display mode 2D/3D	Display size 19"
---------------------------------	-----------------------	---------------------

**Highlights**

- Compact, lightweight and ergonomic design
- Internal Battery with extended life time
- Wide range of transducers with Single crystal technology
- Super Image module: FHI, Multiple Compound Imaging, SRA (Speckle Reduction Algorithm)
- X-contrast, Quad-beam, Quad-flow
- i-Image (intelligent image optimization)
- 2D steer
- Full screen mode



SternMed · Sonos 12

Frequency range 1,5 – 18 MHz	Display mode 2D/3D/4D	Display size 19"
---------------------------------	--------------------------	---------------------

**Highlights**

- Multi-disciplinary compact, lightweight and ergonomic design
- Internal Battery with extended life time
- Wide range of transducers with Single crystal technology
- Wide angle Transvaginal probe(210°)
- LV tracking
- Quantitative Elastography
- Auto breast analysis
- Automatic PW trace and measurement in real time
- Super Image module: FHI,, Multiple Compound Imaging, SRA (Speckle Reduction Algorithm)





# Testing Devices



IBA Dosimetry · DIGI-13

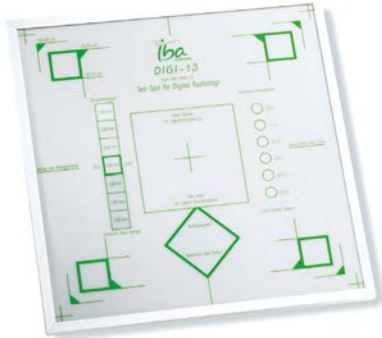

**Highlights**

For quality checks at digital radiographic systems (CR/DR) according DIN 6868-13.

Test parameter:

- Uniformity
- Spatial resolution
- Alignment of light and beam field
- Image scale
- Artifacts
- Geometrical distortion

IBA Dosimetry · ETR1 incl. Centering Tube

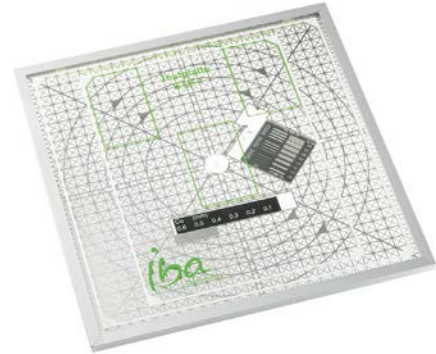

**Highlights**

For quality checks of conventional radiography systems; according DIN 6868-3; including holder for chest wall stand.

Test parameter:

- Spatial resolution
- Low contrast
- Alignment of light and beam field
- Geometrical distortion
- Measuring areas for optical density

IBA Dosimetry · Test Device Primus A

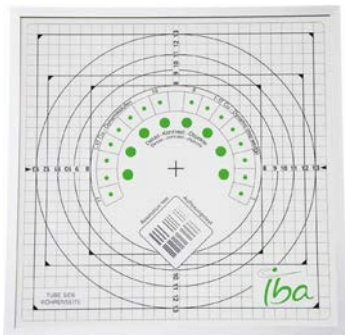

**Highlights**

Test device Primus A is designed according DIN 6868-150 & DIN 6868-4 for Quality assurance at radiography and fluoroscopy systems.

- 17 steps for dynamic verification
- 8 low contrast sensitivity circles
- Grid for easy and efficient determination of light- & beam field alignment as well as geometrical distortions

IBA Dosimetry · Mammo-14



**Highlights**

For quality assurance / constancy test at digital mammography systems according DIN 6868-14.

- 40 mm base plate with integrated Al step wedge and 2 rows of steel balls, for checking the image limitation towards the thorax side.
- 6 mm structural plate with recess for test inserts
- Test insert: PMMA, SDNR & High Contrast
- 3 × 20 mm / 1 × 10 mm / 1 × 4 mm PMMA attenuation plates
- 2 × 20 mm PMMA full field attenuation plate (260 × 320 mm)

IBA Dosimetry · Mammo-152



**Highlights**

For quality assurance / acceptance and constancy tests according DIN 6868-152, DIN 6868-7, IEC 61223-3-2 and EPQC (EUREF) in conventional mammography.

Test parameter:

- Object thickness and tube voltage compensation resp. AEC reproducibility
- Spatial and contrast resolution
- Artifacts / Geometry
- Check of the image limitation towards the thorax side

IBA Dosimetry · Mammo-162



**Highlights**

For quality assurance / acceptance test of digital Mammography Systems, according DIN 6868-162.

- 40 mm base plate with integrated Al step wedge and 2 rows of steel balls, for checking the image limitation towards the thorax side.
- 6 mm structural plate with recess for test inserts
- Test insert: PMMA, SDNR & High Contrast
- 3 × 20 mm / 1 × 10 mm / 1 × 4 mm PMMA attenuation plates
- 1 × 20 mm PMMA full field attenuation plate (260 × 320 mm)

IBA Dosimetry · 2-part PMMA CT-Phantom



**Highlights**

Phantom for measurements of CTDI according IEC 60601-2-44, IEC 61223-3-5, IEC 61223-2-6.

- 1 Adult Head-Phantom, 16 cm diameter, 5 holes
- 1 Adult Body anulus, 32 cm diameter, 4 holes
- 9 Acrylic rods for plugging in all phantom holes

IBA Dosimetry · 3-part PMMA CT-Phantom

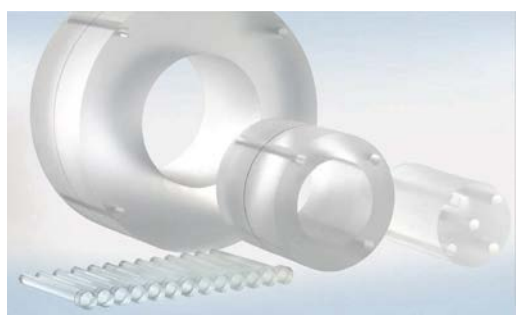

**Highlights**

Phantom for CTDI measurements, according IEC 60601-2-44, IEC 61223-3-5, IEC 61223-2-6.

- Innovative 3-part nested phantom according FDA 21 CFR 1020.33.
- 1 Adult Head anulus, 16 cm diameter, 4 holes
- 1 Adult Body anulus, 32 cm diameter, 4 holes
- 1 Pediatric Phantom, 10 cm diameter, 5 holes
- 13 Acrylic rods for plugging in all phantom holes

IBA Dosimetry · DSA Test Device



**Highlights**

For Quality Assurance of "Digital Subtraction Angiography" (according DIN 6868-150, DIN 6868-4, IEC 61223-3-3)

Test parameter:

- Copper dynamic step wedge with logarithmic check
- DSA contrast sensitivity
- Artefacts

IBA Dosimetry · Multimeter MagicMaX Universal



**Highlights**

Usable with different detectors:

- XR – Radiography/ Fluoroscopy /Dental
- XM – Mammography
- DCT10-MM – Ionization Chamber for CT

Measurement parameter:

Dose / dose rate – dose per pulse – kVp / PPV –time –total filtration – HVL – wave form – dose, dose rate length product for CT

IBA Dosimetry · Dosimax plus I



**Highlights**

Single channel dose meter according IEC 61674 for quality assurance at Radiography-, Fluoroscopy-, Dental- and Mammography systems. Available with RQA/ RQM / DEDX

Measurement parameter (DEDX):

- Dose: 20 µGy – 9,999 mGy
- Dose rate: 20 µGy/s – 400 mGy/s
- Time: 1 ms – 9,999 s

IBA Dosimetry · DVT-3D



**Highlights**

Test of 3D image quality of "Digital Volume Tomography" (DVT) systems, according DIN 6868-150 / DIN 6868-4.

Optional Carbon adapter for easy and precise positioning in the beam without artifacts.

Spatial parameter:

- Detail resolution
- Uniformity and noise
- Laser marks for convenient positioning in iso-center

IBA Dosimetry · Spot-Luminance Meter LXcan



**Highlights**

For luminance measurements at image display devices according to DIN 6868-157, DIN V 6868-57, IEC 61223-2-5 and AAPM TG18.

- Distance and contact measurement
- Easy targeting with a built-in camera and display

- Ultrasound distance sensor for the optimal distance
- Optional photometric detector LX-LS to measure the illuminance in combination with LXcan

IBA Dosimetry · KermaX plus SDP

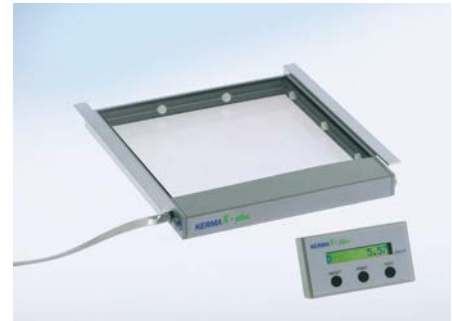

**Highlights**

Easy to install standard dosimeter dedicated to measure DAP and DAP rate for patient dose monitoring. Rectangular, transparent ionization chamber and separate 10-digit background lighting LCD "Single Line Display".

Measurement parameter:

- DAP rate:  $0.01 \mu\text{Gym}^2/\text{s} - 3,000 \mu\text{Gym}^2/\text{s}$
- DAP resolution:  $0.01 \mu\text{Gym}^2$
- Interface:  $1 \times \text{RS232}$  (RIS/HIS or printer)

IBA Dosimetry · KermaX plus IDP



**Highlights**

Ideal solution for a quick and convenient retrofit installation to measure DAP and DAP rate for patient dose monitoring. Rectangular, transparent ionization chamber with integrated 10-digit internal background lighting LCD display.

Measurement parameter:

- DAP rate:  $0.01 \mu\text{Gym}^2/\text{s} - 3,000 \mu\text{Gym}^2/\text{s}$
- DAP resolution:  $0.01 \mu\text{Gym}^2$
- Interface (optional): RS232, RS485

IBA Dosimetry · KermaX plus DDP "Duo"



**Highlights**

Multifunctional duo-channel dosimeter dedicated to measure DAP, DAP rate and exposure time in patient dose monitoring. Two Rectangular, transparent ionization chamber with integrated electronics and one separate "Dual Line Display" with two very bright LED display lines.

Measurement parameter:

- DAP rate:  $0.01 \mu\text{Gym}^2/\text{s} - 3,000 \mu\text{Gym}^2/\text{s}$
- DAP resolution:  $0.01 \mu\text{Gym}^2$
- Interface:  $2 \times \text{RS 232}$  (RIS/HIS and printer)

IBA Dosimetry · KermaX plus TinO IDP



**Highlights**

Two in One – Dose Area Product and dose measurements in one Chamber. Rectangular, transparent ionization chamber with integrated 10-digit internal background lighting LCD display for easy and smart installation at collimator rails.

Measurement parameter:

- DAP rate:  $0.01 \mu\text{Gym}^2/\text{s} - 3,000 \mu\text{Gym}^2/\text{s}$
- DAP resolution:  $0.01 \mu\text{Gym}^2$
- Interface (optional): RS232, RS485, CAN

Quart · dent / digitest Dental QA / QC Test Phantom

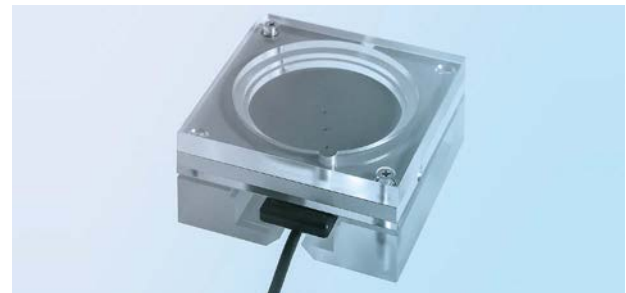

**Highlights**

• Quart dent / digitest 2D dental test phantoms are designed to assess x-ray imaging parameters according to DIN and IEC QA / QC requirements

- Features patient equivalent filtration and test objects to perform full-scale x-ray image quality analyses

**Parameters**

- Spatial resolution
- High-contrast resolution
- Low-contrast resolution
- Homogeneity / artefacts
- Radiation field / tube alignment

Quart · DVTap Cone-Beam CT Test Phantom



**Highlights**

- The Quart DVTap phantom is designed for QA/QC at conebeam CT (CBCT), dental volume tomography (DVT) and 3D imaging equipment.
- It is to be used in dental 3D imaging (according DIN 6868-161 requirements) as well as angiography in C-arm x-ray applications (manufacturer-specific applications). Based on latest research, the solution can also be utilised for standard CT IQ tests.

Quart · DVT 150 CBCT IQ Test Phantom



**Highlights**

- The Quart DVT 150 phantom is designed to meet the requirements of the German DIN 6868-150 x-ray imaging acceptance test standard.
- Handling and positioning of the phantom is easy and straight-forward.
- It enables quick and simple contrast resolution tests for 3D, ENT and angiography x-ray applications.

Quart · mamTOMO Digital Breast Tomosynthesis Phantom

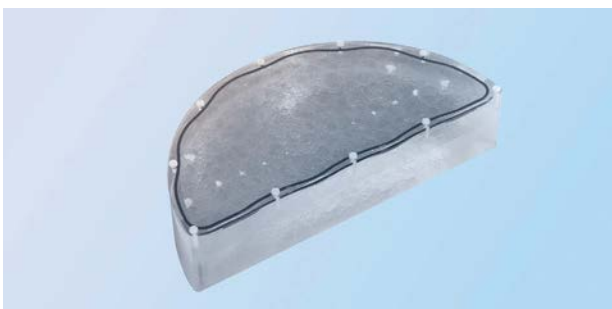

**Highlights**

- The mamTOMO phantom is a novel approach in DBT QA. The phantom incorporates 3D test objects that simulate lesions and non-spiculated masses in a non-homogeneous background.
- An associated automated evaluation software assists at all test stages from image processing, statistic data evaluation to extrapolation of threshold diameters for lesion perceptibility.

Quart · SPdI R/F IQ Phantom

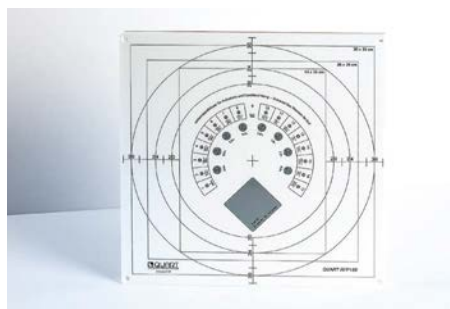

**Highlights**

- The Quart RFP150 phantom enables assessment of digital x-ray equipment according to the German DIN 6868-150 and DIN 6868-4.
- The phantom is available with a unique kV test object to assess radiation quality and generator performance on a routinely basis.
- A small phantom version (SPdI) is available as well as a suspension system for use on wall-mounted x-ray systems.

Quart · Anthropomorphic X-Ray Phantoms

**Highlights**

- Our German-made anthropomorphic phantoms allow repeated x-ray imaging of specific body regions. They are used in x-ray trainings or for specific equipment tests under life-like conditions.
- The phantoms comprise of real human bones embedded in tissue-equivalent material.



Available phantom versions

- Full Body
- Head
- Hand/arm
- Hip/spine
- Foot/leg
- Special training phantoms

Quart · didoNEO R Diagnostic X-Ray Dosemeter

**Highlights**

- The Quart didoNEO introduces a new approach to diagnostic x-ray meters: it features the most compact base unit and most compact detector in the x-ray meter industry. The didoNEO R is used for QA and service in radiography, (Pulsed) fluoroscopy, DSA, dental, 3D (CBCT).
- Compact multi-functional state-of-the-art solid state detector
  - Enables measurements in spots with limited space
  - Measures behind scatter radiation grids
  - Direct measurement of DLP/DWP in dental OPG



### Quart · didoCT Pencil Chamber Meter



#### Highlights

- The Quart didoCT pencil-shaped ion chamber meter is designed for easy and precise dose-width product measurements.
- The meter does not require any pre-setting procedure for direct reading of DWP, rate and time.
- As an optional feature, the Quart didoCT can be supplied with free-in-air direct HVL measurement capability. This device feature is unique and had only been introduced by Quart in a CTDI chamber.

### Quart · didoEASY Diagnostic X-Ray Meters



#### Highlights

- The Quart didoEASY meters are designed for quick measurements of dose, dose rate and exposure time in X-ray QA/QC and service.
- didoEASY meters automatically compensate main radiation qualities in their area of application. Three meter versions are available: for R/F and dental (50 – 150 kV), for mammography (25 – 40 kV), and one for the full diagnostic range (25 – 150 kV).

### Quart · nonius Digital X-Ray Ruler



#### Highlights

- The Quart nonius is a sophisticated, fully electronic x-ray ruler to verify size and geometrical properties of x-ray fields in radiography and mammography. It can also be used to analyse fanned CT or dental OPG x-ray beams.
- Its resolution capabilities and precision go down into to the nonius range of 0.1 mm!
- Take only 3 steps to obtain the test result: Position – Expose – Evaluate.

### Quart · DSA Test Phantom



#### Highlights

- The Quart DSA phantom features longitudinal sliding technique to minimise structural movement artefacts in the test image. It complies with DIN 6868-4, 6868-150 and IEC 61223-3-3.
- A special characteristic of the phantom is that it realistically reproduces the injection procedure of the contrast agent into vessels with different attenuation properties.

### Quart · MRI Test Phantom



#### Highlights

- The Quart MRI test phantom enables assessment of MRI equipment according to the IEC 62464-1 (2018).
- It was the first-to-market product to meet the requirements of the new MRI QA standard.
- The phantom is associated with a QA image scoring software which introduces a new approach and allows time-efficient MRI QA procedures.

### Radcal · Accu-Gold Windows-based Systems for X-Ray QA



#### Highlights

- The most dynamic x-ray QA meter available
- Supports all medical x-ray modalities
- Operates with all of Radcal's ion chambers, solid state, mA and light sensors
- Includes customizable easy-to-use software
- Report generation
- Waveform analysis
- Optional WiFi capability

Radcal · Touch Systems for X-Ray QA



Touch Stand-alone Systems

Touch Professional Systems

Highlights

- Stand-alone diagnostic test meter
- Supports all x-ray modalities
- Reliably captures Dose, Dose Rate, kV, HVL, Filtration, mA and more
- Rechargeable Battery
- Stores all measurement data

Highlights

- Stand-alone diagnostic test meter
- Computer connectivity – WiFi and USB
- Supports all x-ray modalities
- Reliably captures Dose, Dose Rate, kV, HVL, Filtration, mA and more
- Rechargeable Battery
- Report generation and Waveform analysis
- Stores all measurement data

Radcal · DAP Calibration Sensors

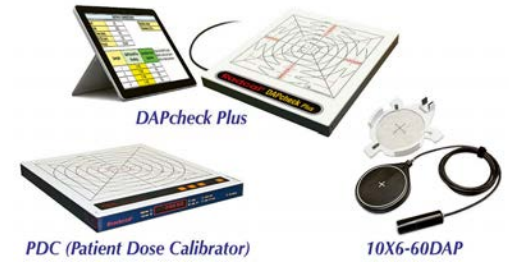

DAPcheck Plus

PDC (Patient Dose Calibrator)

10X6-60DAP

Highlights

Radcal provides Dose Area Product (DAP) calibration sensors as part of the Accu-Gold+ product family. These sensors provide quick and easy calibration of installed DAP meters by providing accurate measures of DAP and DAP rate.

Highlights

- Ideal for Dose Area Product (DAP) of Pan-Dental or CBCT-Dental
- Easy to use mounting alignment fixture
- Unit selection of Gy-m<sup>2</sup> or Gy-cm<sup>2</sup>
- Flat energy response
- Plug and Play with your existing Radcal Touch or Accu-Gold system – no calibration adjustments

Radcal · Sensors Selections



Highlights

Radcal provides the most comprehensive line of diagnostic x-ray sensors in the industry, including solid-state Multisenors, cost-effective solid-state dose sensors, and gold standard ion chambers.

RTI Group · Ocean Next software



Highlights

The new power in X-ray QA software. The industry-leading Ocean Next – with its three different license levels of Quick, Advantage, and Professional – is a swift, easy-to-use application for routine controls, or customized application with workflow, automatic tests, and traceability. It is compliant with all Piranha and Cobia meters as well as the RTI Scatter Probe.

RTI Group · CT Ion Chambers 10 & 30 cm



Highlights

The RTI CT Ion Chambers 10 cm and 30 cm are both pencil-type ion chambers intended for measuring the exposure output level of CT scanners in a CTDI Phantom or free-in-air. The Ion Chambers are compatible with the RTI Chamber Adapter for use with the Piranha and Cobia meters. They can also be used with the older RTI Barracuda and Solidose 400 models.

RTI Group · Cobia



Highlights

Cobia is RTI's easy-to-use solution for quick and efficient measurements of a variety of radiography and fluoroscopy parameters. All Cobias are wireless, come ready-to-use with Bluetooth connection, and include Ocean Next software. Select the model that suits your needs, and only pay for what you need to measure!

RTI Group · Piranha



**Highlights**

Piranha is RTI's premium platform for reliable QA. All Piranhas are wireless, come ready-to-use with Bluetooth connection, and include Ocean Next software. The Piranha MULTI model can be used for X-ray QA of all modalities - R/F, Dental, Mammo, and CT - whereas the other four meters are dedicated to one specific modality. With automatic connection to various RTI accessories, just plug and play!

RTI Group · Scatter Probe



**Highlights**

A leakage and scatter detector in one! The revolutionary RTI Scatter Probe is a rugged, flat, solid-state detector for leakage and scatter detection in X-ray environments. Its unique design - two separate detector areas of 10 cm<sup>2</sup> and 100 cm<sup>2</sup> - fulfills current regulations and standards for X-ray leakage and scatter measurements. Connects to Ocean Next software for reading and reporting.

VacuTec · AEC Chamber



**Highlights**

Digital interface ensures EMC stable signal transmission and provides an open dose working range.

Technical specs:

- Tube voltage: 40 kV ... 150 kV
- Dose rate range: 0.5 ... 1,000 µGy/s
- Aluminum equivalent: <0.75 mm Al

- Analog interface: ramp voltage 0 - 10 V
- Digital interface: differential pulses (RS422)
- Resolution: 0.025 µGy
- Pulse width: 2 µs

VacuTec · VacuDAP-C/VacuDAP-C duo



**Highlights**

The VacuDAP-C systems for measurement of DAP and Dose are basically integrated in interventional devices with customized calibration settings.

Technical specs:

- Resolution DAP: 0.01 µGym<sup>2</sup>
- Resolution Dose: 0.005 mGy
- Interface: RS485, RS232, Bluetooth, CAN, USB
- Active area: Ø (8 ... 100) mm

VacuTec · VacuDAP compact



**Highlights**

- VacuDAP chamber with integrated display
- Perfect suitable for retrofits and mobile X-ray units
- The battery ensures simplest installation ever

Technical specs:

- Resolution DAP: 0.01 µGym<sup>2</sup>
- Active area: 123 × 123 mm / 147 × 147 mm
- Battery operation time: about 24 h

VacuTec · VacuDAP / VacuDAP duo



**Highlights**

The VacuDAP family provides a wide range of DAP and Dose measuring solutions for most of the diagnostic X-ray systems in the market.

Technical specs:

- Resolution DAP: 0.01 µGym<sup>2</sup>
- Resolution Dose: 0.003 mGy
- Interface: RS485, RS232, Bluetooth, CAN, USB
- Active area: 123 × 123 mm / 147 × 147 mm







Company Name	Contact Information	Logo	Computed Tomography	Magnetic Resonance Imaging	Injectors	Interventional Systems	Artificial Intelligence	IT Systems	Women's Health	R/F Systems	Molecular Imaging	Displays	Printers	Ultrasound	Testing Devices
<b>AB-CT – Advanced Breast-CT GmbH</b>	Henkestr. 91 91052 Erlangen, Germany tel +49 9131 97 31 00 ask.crm@ab-ct.com www.ab-ct.com		■						■						
<b>Agfa HealthCare</b>	Septestraat 27 2640 Mortsel, Belgium tel +32 3 444 94 44 agfahealthcareinfo.be@agfa.com www.agfa.com							■							
<b>Agfa</b>	Septestraat 27 2640 Mortsel, Belgium tel +32 3 444 21 11 www.agfa.com									■			■		
<b>allMRI GmbH</b>	Südstr. 23 74226 Nordheim, Germany tel +49 7133 237 02 20 mail@allmri.com www.allmri.com			■											
<b>Arcoma AB</b>	Annavägen 1 352 46 Växjö, Sweden tel +46 470 70 69 00 service@arcoma.se www.arcoma.se									■					
<b>BMS Informationstechnologie GmbH</b>	Diesterweggasse 7/1 1140 Vienna, Austria tel +43 1 524 81 34 00 info@bms-austria.com www.easydose.eu							■							
<b>Canon Electron Tubes &amp; Devices Co., Ltd.</b>	1385 Shimoishigami Otawara-shi, Tochigi 324-8550, Japan tel +81 287 26 66 66 https://etd.canon/eng		■			■				■					
<b>Canon Europe NV</b>	Medical Components Business Group Bovenkerkerweg 59 1185 XB Amstelveen, The Netherlands tel +31 205 45 89 26 medical.drsales@canon-europe.com www.canon-europe.com/medical							■		■					
<b>Canon Medical Systems Europe B.V.</b>	Zilverstraat 1 2718 RP Zoetermeer, The Netherlands tel +31 79 368 92 22 <a href="http://eu.medical.canon">eu.medical.canon</a>		■			■	■			■					
<b>Cefa s.c.</b>	Via Selice Provinciale 23A 40026 Imola (BO), Italy tel +39 0542 653 441 info@newtom.it www.newtom.it		■												
<b>DEL MEDICAL</b>	28 Calvert Street, Harrison, NY 10528, USA tel +1 800 261-9808 241 Covington Drive, Bloomingdale, IL 60108, USA tel +1 800 800-6006 www.delmedical.com									■					

# Companies & Suppliers

Company Name	Address	Logo	Computed Tomography	Magnetic Resonance Imaging	Injectors	Interventional Systems	Artificial Intelligence	IT Systems	Women's Health	R/F Systems	Molecular Imaging	Displays	Printers	Ultrasound	Testing Devices
<b>DK Medical Systems Co.,Ltd</b> 18, Baumoe-ro 7-gil, Seocho-gu, Seoul, 06762, Korea tel +82 2 529 6190 global@dk.co.kr www.dk.co.kr										■					
<b>DRGEM Corporation</b> 7F, E-B/D Gwangmyeong Techno-Park, 60 Haan-ro, Gwangmyeong-si, Gyeonggi-do, Korea tel +82 2 869 85 66 sales@drgem.co.kr www.drgem.co.kr										■					
<b>Philips Medical Systems DMC GmbH</b> Röntgenstr. 24 22335 Hamburg, Germany marketing.dunlee@philips.com www.dunlee.com			■	■											
<b>EXAMION GmbH</b> Erich-Herion-Str. 37 70736 Fellbach, Germany tel +49 711 12 00 02-0 vertrieb@examion.com www.examion.com								■		■					
<b>Febromed GmbH &amp; Co. KG</b> Am Landhagen 52 59302 Oelde, Germany tel +49 2522 9 20 19 00 info@febromed.de www.febromed.com			■	■											
<b>FUJIFILM Europe GmbH</b> Heesenstr. 31 40549 Düsseldorf, Germany tel + 49 211 508 90 www.fujifilm.com							■	■	■	■					
<b>GCTechnology GmbH</b> Freidling 12 84172 Buch am Erlbach, Germany tel +49 8706 94 15 00 info@gctech-gmbh.com www.gctech-gmbh.com			■	■		■									
<b>GLEAMER</b> 117 Quai de Valmy 75010 Paris, France tel +33 6 08 18 12 01 contact@gleamer.ai www.gleamer.ai							■								
<b>GMM GROUP</b> Via Partigiani, 25 24068 Seriate (BG), Italy tel +39 035 452 53 11 info@gmmspa.com www.gmmspa.com						■				■					
<b>Guerbet</b> BP 57400 95943 Roissy CdG Cedex, France tel +33 1 45 91 50 00 LF@guerbet.com www.guerbet.com								■							
<b>Hologic bvba</b> Da Vincilaan 5, Building Caprese 1930 Zaventem, Belgium tel +32 2711 46 80 EUInfo@hologic.com www.hologic.com									■	■				■	

Company Name	Logo	Computed Tomography	Magnetic Resonance Imaging	Injectors	Interventional Systems	Artificial Intelligence	IT Systems	Women's Health	R/F Systems	Molecular Imaging	Displays	Printers	Ultrasound	Testing Devices
<b>I.A.E. S.p.A.</b> Via Fabio Filzi, 53 20032 Cormano (MI), Italy tel +39 02 66 30 32 55 iaexray@iae.it www.iae.it		■			■			■	■					
<b>IBA Dosimetry GmbH</b> Bahnhofstr. 5 90592 Schwarzenbruck, Germany tel +49 91 28 607-0 salesdiagnostic@iba-group.com www.iba-dosimetry.com www.iba-dosimetry.de														■
<b>IMAGE Information Systems Europe GmbH</b> Lange Str. 16 18055 Rostock, Germany tel +49 381 496 58 20 info@image-systems.biz www.image-systems.biz							■							
<b>IMS Giotto S.p.A. – GMM GROUP –</b> Via Sagittario, 5 40037 Sasso Marconi (BO), Italy tel +39 51 84 68 51 imscomm@imgiotto.com www.imgiotto.com								■						
<b>INTERMEDICAL SRL</b> Via E. Fermi, 26 24050 Grassobbio (BG), Italy tel +39 035 659 48 11 info@inter-med.it www.inter-med.it					■				■					
<b>i-SOLUTIONS Health GmbH</b> Ein Unternehmen der Mesalvo Gruppe Am Exerzierplatz 14 68167 Mannheim, Germany tel +49 621 39 28-0 info@i-solutions.de www.i-solutions.de							■							
<b>JVCケンウッド Deutschland GmbH</b> Konrad-Adenauer-Allee 1 – 11 61118 Bad Vilbel, Germany tel +49 2161 69 84-180 medical-display.e@jvckenwood.com healthcare.jvc.com											■			
<b>Konica Minolta Business Solutions Europe GmbH</b> Capellalaan 65 2132 JL Hoofddorp, The Netherlands healthcare@konicaminolta.eu www.konicaminolta.eu/healthcare							■		■			■	■	
<b>medavis GmbH</b> Bannwaldallee 60 76135 Karlsruhe, Germany tel +49 721 929 10-0 info@medavis.de www.medavis.de							■							
<b>medigration GmbH</b> Dr.-Rudolf-Eberle-Str. 8 – 10 76534 Baden-Baden, Germany tel + 49 7223 9669 860 medigration@bendergruppe.com www.medigration.de							■	■	■		■			
<b>MEDTRON AG</b> Hauptstr. 255 66128 Saarbrücken, Germany tel +49 681 970 17-0 info@medtron.com www.medtron.com				■										

# Companies & Suppliers

Company Name	Contact Information	Logo	Computed Tomography	Magnetic Resonance Imaging	Injectors	Interventional Systems	Artificial Intelligence	IT Systems	Women's Health	R/F Systems	Molecular Imaging	Displays	Printers	Ultrasound	Testing Devices
<b>Medtronic International Trading Sàrl</b> Route du Molliou 31 1131 Tolochenaz, Switzerland tel +41 21 802 70 00 www.medtronic.com/emea/o-arm			■			■									
<b>SHENZHEN MINDRAY</b> BIO-MEDICAL ELECTRONICS CO., LTD. Mindray Building, Keji 12th Road South Nanshan, Shenzhen 518057, China tel +86 755 81 88 89 98 intl-market@mindray.com www.mindray.com							■			■				■	
<b>NEXUS / CHILI GmbH</b> Friedrich-Ebert-Str. 2 69221 Dossenheim / Heidelberg, Germany tel +49 6221 180 79 10 sales@nexus-chili.com www.nexus-chili.com								■				■			
<b>NORAS MRI products GmbH</b> Leibnizstr. 4 97204 Höchberg, Germany tel +49 931 29 92 70 mri@noras.de www.noras.de				■											
<b>NRT X-RAY A/S</b> Birkegaardsvej 16 8361 Hasselager, Denmark tel +45 86 28 35 00 nrt@nrtxray.com www.nrtxray.com										■					
<b>OR Technology</b> Oehm und Rehbein GmbH Neptunallee 7c 18057 Rostock, Germany tel +49 381 36 60 06 00 info@or-technology.com www.or-technology.com								■		■					
<b>Planmed Oy</b> Sorvaajankatu 7 00880 Helsinki, Finland tel +358 20 779 53 00 sales@planmed.com www.planmed.com			■						■						
<b>PTW Freiburg GmbH</b> Lörracher Str. 7 79115 Freiburg, Germany tel +49 761 490 55-0 info@ptwdosimetry.com ptwdosimetry.com			■						■	■					
<b>QUART GmbH</b> Kirchenweg 7 85604 Zorneding, Germany tel +49 8106 24 91 18 info@quart.de www.quart.de															■
<b>Radcal Corporation</b> 426 West Duarte Road Monrovia, CA 91016, USA tel +1 626 357 79 21 sales@radcal.com www.radcal.com															■
<b>RTI Group</b> Flöjelbergsgatan 8C 43137 Mölndal, Sweden tel +46 31 746 36 27 sales@rtigroup.com www.rtiigroup.com															■

Company Name	Computed Tomography	Magnetic Resonance Imaging	Injectors	Interventional Systems	Artificial Intelligence	IT Systems	Women's Health	R/F Systems	Molecular Imaging	Displays	Printers	Ultrasound	Testing Devices
<b>ScreenPoint Medical</b> Toernooiveld 300 6525 EC Nijmegen, The Netherlands tel +31 242 020 020 info@screenpointmed.com www.screenpoint-medical.com					■								
<b>Shimadzu Europa GmbH</b> Medical Business Unit Albert-Hahn-Str. 6 – 10 47269 Duisburg, Germany tel +49 203 76 87-0 medical@shimadzu.eu www.shimadzu-medical.eu				■				■					
<b>Siemens Healthineers Headquarters Siemens Healthcare GmbH</b> Henkestr. 127 91052 Erlangen, Germany tel +49 800 188 188 5 siemens.com/healthineers	■	■		■	■	■		■	■			■	
<b>Solutions for tomorrow</b> Saxagårdsvägen 1 36251 Väckelsång, Sweden tel +46 10 456 45 00 info@solutionsfortomorrow.se www.solutionsfortomorrow.se								■					
<b>STEPHANIX</b> 10, Rue Jean Moulin 42150 La Ricamarie, France tel +33 477 47 81 60 contact@stephanix.com www.stephanix.com				■				■					
<b>SternMed GmbH</b> Schubertstr. 31 88214 Ravensburg, Germany tel +49 751 35 97 80 email@sternmed.de www.sternmed.de	■	■		■			■	■				■	
<b>Swissray Technologies AG</b> Turbistr. 25 6280 Hochdorf, Switzerland tel +41 41 914 12 12 info@swissray-technologies.com www.swissray-technologies.com				■		■		■					
<b>Technix S.p.A.</b> Via Fermi 45 24050 Grassobbio (BG), Italy tel +39 035 384 66 11 technixd@technix.it www.technix.it				■				■					
<b>Transatlantic</b> Siemensstr. 21–23 61267 Neu-Anspach, Germany tel +49 60 81 94 30 50 info@transat.de www.transatlantic.de			■										
<b>Ultrasound Technologies LTD</b> Lodge Way, Portskewett, Caldicot, South Wales, NP26 5PS, U.K. tel +44 12 91 42 54 25 ultratec@doppler.co.uk www.doppler.co.uk	■												
<b>VacuTec Meßtechnik GmbH</b> Dornblüthstr. 14a 01277 Dresden, Germany tel +49 351 317 24-0 info@vacutec-gmbh.de www.vacutec-gmbh.de													■

Company	Computed Tomography	Magnetic Resonance Imaging	Injectors	Interventional Systems	Artificial Intelligence	IT Systems	Women's Health	R/F Systems	Molecular Imaging	Displays	Printers	Ultrasound	Testing Devices
<b>VILLA SISTEMI MEDICALI s.p.a.</b> Via delle Azalee, 3 20090 Buccinasco (MI), Italy tel +39 02 48 85 91 vsminfo@villasm.com www.villasm.com													
<b>Ziehm Imaging GmbH</b> Lina-Ammon-Str. 10 90471 Nürnberg, Germany tel +49 911 21 72 - 0 info@ziehm.com www.ziehm.com													

## RADBOOK

**Mediengruppe Oberfranken**  
 Fachverlage GmbH & Co. KG  
 E.-C.-Baumann-Straße 5  
 95326 Kulmbach, Germany  
 Phone: +49 9221 949-311

**Managing Directors**  
 Walter Schweinsberg, Bernd Müller

**Publishing Director**  
 Mareike Scholze

**Production Management**  
 Sonja Buske

**Consultant**  
 Guido Gebhardt

**Representatives**  
 Eric Jund (E, F, IT)  
 Jund@european-hospital.com  
 Simon Kramer (Benelux, GB, Scandinavia)  
 kramer@european-hospital.com

Ralf Mateblowski (DACH)  
 r.mateblowski@mgo-fachverlage.de

Hanna Politis (USA, CA)  
 hanna@media-intl.com

Maria Kaiser (USA, CA)  
 mkads@mac.com

Charles Yang (TW)  
 charles\_yang@medianet.com.tw

Gavin Hua (CN)  
 627416876@qq.com

**Subscription**  
 Simone Sesselmann  
 kundenservice@mgo-fachverlage.de  
 Subscription rate: € 15.– plus postage

**Art Director**  
 Friedrich Oertel  
**Printed by**  
 mgo360 GmbH & Co. KG, Bamberg

**Disclaimer**  
 The information and opinions expressed in articles and product entries published in RADBook are solely those of the manufacturers / companies, their authors and contributors, for which the publisher holds no responsibility.

All trademarks, product names, company names and logos in this publication are the property of their respective holders. Users must obtain permission from those holders before copying or using the owner's trademarks, product and company names or logos. Errors and omissions excepted. Not all products are available in all European countries. Medical devices placed on the market in the EU must bear a CE mark. Information on their classification, notified body number and authorised European representative can be obtained from the respective manufacturer. Please note that the manufacturers' websites may contain further product disclaimers.

© 2022 by Mediengruppe Oberfranken, Fachverlage GmbH & Co. KG. All rights reserved.

**mgo** fachverlage A brand of Mediengruppe Oberfranken

# For healthcare professionals. For you.



Discover your topics in our healthcare journals.  
We offer a broad range of publications in the field of healthcare.



[mgo-fachverlage.de/healthcare](https://mgo-fachverlage.de/healthcare)

**mgo** fach  
verlage

Mediengruppe Oberfranken – Fachverlage GmbH & Co. KG  
E.-C.-Baumann-Str. 5 · 95326 Kulmbach · Germany

# NAEOTOM Alpha with Quantum Technology CT redefined.



## Experience a defining moment in computed tomography

We are proud to introduce the world's first photon-counting CT. NAEOTOM Alpha® with Quantum Technology is nothing less than the total reinvention of computed tomography.

Based on the revolutionary direct signal conversion of its QuantaMax detector, NAEOTOM Alpha offers high-resolution images at minimal dose, spectral information in every scan, and improved contrast at lower noise.

Benefit from a range of clinical options and breakthrough consistency never seen before – for confident clinical decision-making and the potential to scan previously excluded patients.

[siemens-healthineers.com/naeotom-alpha](https://siemens-healthineers.com/naeotom-alpha)